

2019 | EN  
**DENTAL  
CATALOG**

**ASA DENTAL**

**ASA DENTAL**  
MAKE PEOPLE SMILE

WELCOME TO ASA DENTAL PRODUCT CATALOGUE, OUR SELECTION OF INSTRUMENTS AND DISPOSABLE THAT CONTRIBUTED TO THE WRITING OF 50 YEARS OF HISTORY IN MODERN DENTISTRY.

INSPIRED BY A SIMPLE VISION, MAKING PEOPLE SMILE, WE STRIVE TO MANUFACTURE DENTAL INSTRUMENTS THAT HELP DENTAL PROFESSIONALS IMPROVE THE QUALITY OF LIFE OF MILLIONS OF PATIENTS, ANYWHERE IN THE WORLD.

## INDEX

---

2   7	CORPORATE
8   11	SCIENTIFIC NAME INDEX
A1   A23	ASAONE DISPOSABLE PRODUCTS
B1   B25	DIAGNOSTIC
C1   C47	ORAL SURGERY
D1   D71	EXTRACTIVE SURGERY
E1   E41	IMPLANT SURGERY
F1   F51	RESTORATIVE
G1   G37	PERIODONTAL
H1   H37	ORTHODONTIC
I1   I19	INSTRUMENT CASSETTES AND TRAYS
J1   J43	IMPRESSION TRAYS
K1   K35	LABORATORY INSTRUMENTS
12   15	REPROCESSING GUIDELINES
16   49	CODE INDEX
50   55	NAME INDEX

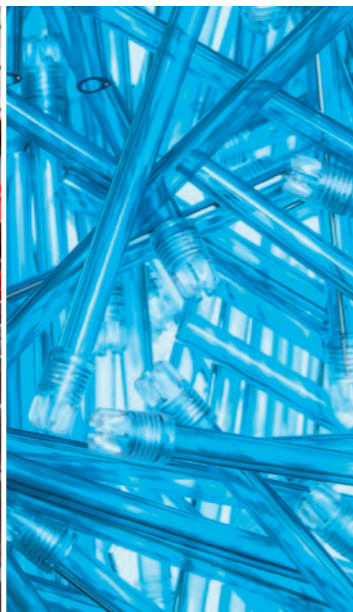
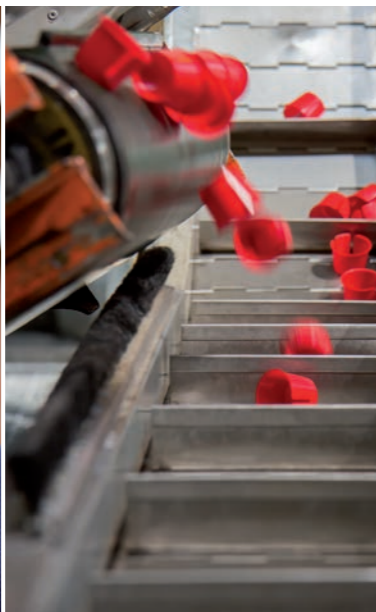

**1961**  
**FOUNDATION**

The intuition of Aldo Puccetti becomes a company: Asa Dental is born

**1975**  
**MARLIA**

Plant in Marlia starts production to satisfy increasing market demand

**2004**  
**KALTOPLAST**

Asa Dental acquisition of Kaltoplast consolidates company's leading position as disposable saliva ejector manufacturer

**2010**  
**ASA DENTAL USA**

International presence consolidates with Asa Dental USA subsidiary opening

**2013**  
**ASA DENTAL CHINA**

Asa Dental China becomes operative, supporting one of the fastest growing markets

**2015**  
**BOZZANO**

Smart warehouse in Italy powers logistics to minimize delivery time

**2018**  
**DUBAI**

Asa Dental consolidates its presence in the Middle East with a new subsidiary in Dubai

**1965**  
**MANIAGO**

Maniago production plants opens. Stainless steel instruments complement disposables offering

**2001**  
**DERBY DENTAL**

Asa Dental acquires Derby Dental and extends product portfolio

**2009**  
**ALESSANDRO MALFATTI**

A leadership turning point: Alessandro Malfatti becomes General Manager

**2012**  
**ASAONE**

Investments to boost production efficiency for disposable products to increase quality, quantity and competitiveness

**2014**  
**MANIAGO**

Maniago plants improves stainless steel instruments productivity and quality

**2016**  
**EDUCATIONAL CENTER**

The new Educational Center connects leaders, Universities and dental professionals

**2019**  
**DIGITAL INTEGRATION**

Digital technologies connect product design, development and communication

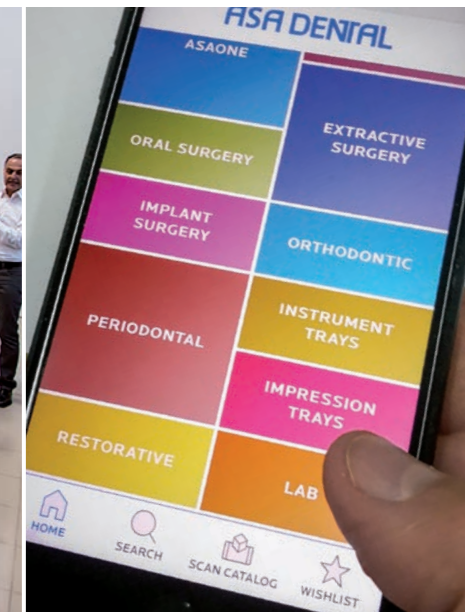
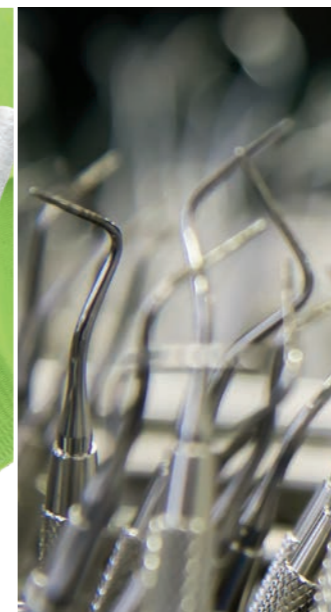
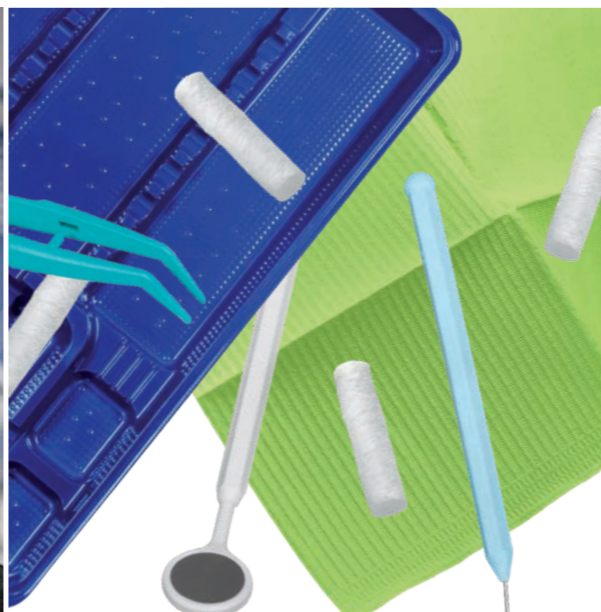

## A GLOBAL PRESENCE

Making people smile, anywhere in the world, means being close to dental professionals, develop a deep understanding of the underlying differences of each market and tailor products and solutions to the exact needs of qualified professionals.

Through a structured international presence, with subsidiaries in USA, China and UAE, Asa Dental can operate at maximum efficiency at a global level, yet meet market requests at local level. Headquarters in Italy coordinates production, sales and logistics, managing an offer of innovative and traditional solutions powered by creative design and quality manufacturing, the contemporary interpretation of *made in Italy* spirit.

We proudly serve qualified dentists in more than 170 countries, helping them improve the quality of life of millions of patients and staying true to our mission by making effective dentistry accessible to everyone. Everywhere.

C. CHINA

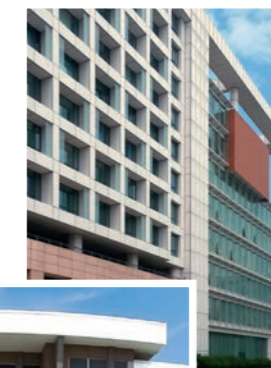

D. UAE



B. USA

A. ITALY



# INNOVATION MEETS TRADITION

Production has become Asa Dental second nature from the very beginning.

Bucking a worldwide trend of decentralized production, we have decided to concentrate the entire manufacturing in Italy and guarantee our clients with the unmatched quality they deserve. The strict control over the whole production processes of disposable products and stainless steel instruments translates into a constant improvement of product quality and operational efficiency.

Each production plant focuses on its core competences, allowing employees to increase expertise and processes to be optimized. Regardless of the product, we can keep on responding to constantly shifting markets, whether in terms of quantity, quality or application.

With hundreds of thousands of products delivered every year, uncompromising quality testing and absolute traceability of products guarantee qualified dentists that every single product they use delivers all the necessary effectiveness, safety and comfort their patients demand.



# SCIENTIFIC NAME INDEX

scientific name	instrument type	page
<b>Adams</b>	Wire forming pliers	H20
<b>Aderer</b>	Wire forming pliers	H21
<b>Adson</b>	Needle holders	C10
	Tissue pliers	C38, E36
<b>Adson Brown</b>	Tissue pliers	C41
<b>Ainsworth</b>	Punching forceps	F8
	Punching forceps - AsaLady	F9
<b>Allen</b>	Periosteals and Elevators	E23, G16
<b>Angle</b>	Wire forming pliers	H15, H19
<b>Apexo</b>	Root elevators	D54, D60
<b>Arruga</b>	Needle holders	C15
<b>Backhaus</b>	Towel clamps	C31
<b>Ball</b>	Filling instruments - Burnishers	F31
<b>Barnhart</b>	Curettes and Scalers	G5
<b>Baumgartner</b>	Needle holders	C11
<b>Beale</b>	Periosteals and Elevators	E22, G16
	Wax and modelling carvers	K16
<b>Bein</b>	Root elevators	D47, D48, D59
<b>Beyer</b>	Bone rongeurs	D44
<b>Black</b>	Cavity preparation instruments - margin trimmers	F18
	Cavity preparation instruments - hatchets	F19
<b>Blumenthal</b>	Bone rongeurs	D43, E30
<b>Böhm</b>	Crown pliers	F43, K29
<b>Boley</b>	Calipers	F42, K30
<b>Bowman</b>	Antrum probes	C37
<b>Brewer</b>	Clamp forceps	F9
<b>Brünings</b>	Tongue depressors	C34
<b>Buchwald</b>	Tongue depressors	C34
<b>Buck</b>	Gingivectomy knives	G24, G25
<b>Buckley</b>	Bone chisels and gouges	G27
<b>Buser</b>	Excisers	E22
	Membrane placement instruments	E31
<b>Castroviejo</b>	Needle holders	C6, C18, C19, E5, E6
<b>Castroviejo-Barraquer</b>	Needle holders	C19
<b>Cattoni</b>	Double ended Explorers	B8
<b>Chompret</b>	Syndesmotomes	D65
	Syndesmotomes - AsaLady	D65

scientific name	instrument type	page
<b>Cleveland</b>	Bone rongeurs	D42
<b>Cleveland-Gardner</b>	Bone rongeurs	D42
<b>Cogswell</b>	Root elevators	D54
<b>Coleman</b>	Root elevators	D46
<b>Collin</b>	Tongue forceps	C33
<b>Columbia</b>	Curettes and Scalers	G4
	Tongue depressors	C34
<b>Cooley</b>	Tissue pliers	C38
<b>Coupland</b>	Root elevators	D56, D58
<b>Crane-Kaplan</b>	Periodontal pocket markers	E35
	Curettes and Scalers	G8
	Gingivectomy knives	G25
	Periodontal pocket markers	G31
<b>Crile</b>	Hemostats	C20
<b>Crile-Wood</b>	Needle holders	C10, C11
<b>Cryer</b>	Extracting forceps - American pattern	D28, D32
	Root elevators	D55, D60
<b>Curtis</b>	Root elevators	D53
<b>Darby-Perry</b>	Excavators	F17
<b>De La Rosa</b>	Wire forming pliers	H18
<b>De Marco</b>	Curettes and Scalers	G5
<b>Dean</b>	Gum scissors	C7
<b>Delphin</b>	Wire forming pliers	H10
<b>Derf</b>	Needle holders	C13
<b>Didner</b>	Matrix retainers	F46
<b>Eiselberg-Mathieu</b>	Needle holders	C15
<b>Fahnenstock</b>	Wax knives	K22
<b>Farabeuf</b>	Retractors	C35
<b>Felt</b>	Felt composite instruments	F32
<b>Fine Swedish</b>	Needle holders	C14
<b>Flagg</b>	Cotton and dressing pliers	B4
	Cotton and dressing pliers - AsaLady	B5
<b>Flohr</b>	Root elevators	D49, D58, D59
<b>Foc</b>	Filling instruments	F30
<b>Frahm</b>	Amalgam carvers	F37
	Wax and modelling carvers	K13
<b>Frazier</b>	Surgical saliva ejectors	C44
<b>Freer</b>	Chisels	E16

scientific name	instrument type	page
	Periosteals and Elevators	E24, G17
<b>Friedman</b>	Root elevators	D57
	Bone rongeurs	D42
<b>Furrer</b>	Copper rings removing pliers	F43
<b>Gardner</b>	Bone chisels and gouges	G27
<b>Gillies</b>	Needle holders	C14
<b>Goldman-Fox</b>	Bone/soft tissue nippers	E29, D44
	Combination Explorers - Probes	B10
	Curettes and Scalers	G6
	Gingivectomy knives	G25
	Gum scissors	C3, C4, E4
	Periodontal pocket probes	G3
	Bone/soft tissue nippers	G30
	Periosteals and Elevators	E22
<b>Goldman-Fox (Crane-Kaplan)</b>	Periodontal pocket markers	B3, E35, G31
<b>Goldman-Fox (special)</b>	Gum scissors	C4
<b>Goldman-Fox Williams</b>	Combination Explorers - Probes	B11
<b>Gracey</b>	Gracey curettes	G11
	Gracey curettes - AF	G12
	Gracey curettes - MF	G13
<b>Greenstein</b>	Ceramic sculpturing instruments	K21
<b>Gritman</b>	Plaster knives	K23
	Wax and modelling carvers	K16
<b>Gross-Maier</b>	Dressing forceps	C32
<b>Halsey</b>	Needle holders	C13
<b>Halsey-Smooth</b>	Needle holders	C13
<b>Halstead-Mosquito</b>	Hemostats	C21
	Hemostats - AsaLady	C21
	Hemostats	F44
	Elastic forceps	H36
<b>Harris</b>	Extracting forceps - American pattern	D26
	Extracting forceps - American pattern, AsaLady	D30
<b>Hartmann</b>	Hemostats	C23
<b>Hegar-Baumgartner</b>	Needle holders	C11
<b>Heidbrink</b>	Root elevators	D54, D60
	Root-tip picks	D63, D64
<b>Heidemann</b>	Separating spatulas	F23, F24
	Separating spatulas - AsaLady	F24
<b>Hemingway</b>	Bone curettes	C45, E21, G20
<b>Herbert</b>	Mallets	G29
<b>Hirschfeld</b>	Files	G22

scientific name	instrument type	page
<b>Hollenback</b>	Amalgam carvers	F36
	Filling instruments - amalgam instruments	F28
	Wax and modelling carvers	K13
<b>Hopkins</b>	Periosteals and Elevators	E24, G17
<b>How</b>	Wire forming pliers	H23
<b>Hourigan</b>	Periosteals and Elevators	E23, G16
<b>Hull</b>	Extracting forceps - American pattern	D27
	Extracting forceps - American pattern, AsaLady	D31
<b>Hylin</b>	Root elevators	D45
	Wax and modelling carvers	K14
<b>Hylin-Le Cron</b>	Wax and modelling carvers	K14
<b>Indiana University</b>	Curettes and Scalers	G5
<b>Iris</b>	Gum scissors	C4, C5
<b>Ivory</b>	Punching forceps	F8
	Clamp forceps	F9
	Clamp forceps - AsaLady	F10
<b>Iwanson</b>	Calipers	F42, K30
<b>Jacquette</b>	Curettes and Scalers	G9
	Scalers	G15
<b>Jameson</b>	Calipers	K30
<b>Jarabak</b>	Wire forming pliers	H27
<b>Johnson</b>	Wire forming pliers	H20
<b>Jones</b>	Towel clamps	C31
<b>Kelly</b>	Gum scissors	C5, E4
	Hemostats	C23, F44
<b>Kilner</b>	Retractors	C35
<b>Kirkland</b>	Gingivectomy knives	G24
<b>Klein</b>	Extracting forceps for children	D39
<b>Kocher</b>	Hemostats	C20
	Retractors	C36
<b>König</b>	Periosteals and Elevators	E25, G18
<b>Kopp</b>	Root elevators	D50
<b>La Grange</b>	Gum scissors	C7
<b>Ladmore</b>	Filling instruments - Burnishers	F31
<b>Langenbeck</b>	Retractors	C36
<b>Langer</b>	Curettes and Scalers	G5
<b>Lecluse</b>	Root elevators	D63
<b>Le Cron</b>	Wax and modelling carvers	K15
<b>Lessmann</b>	Wax knives	K22
<b>Lichtenberg</b>	Needle holders	C15, E5
<b>Locklin</b>	Gum scissors	C6
<b>London College</b>	Cotton and dressing pliers	B4
	Cotton and dressing pliers - AsaLady	B5

scientific name	instrument type	page
<b>London Hospital</b>	Root elevators	D46
<b>Lucas</b>	Bone curettes	G20
<b>Luer</b>	Bone rongeurs	D42, E30
<b>Luks</b>	Root-canal Pluggers	B13
<b>Luniatschek</b>	Ligature instruments	H36
	Gauze packers	F39
<b>Mac Millan</b>	Root elevators	D56
<b>Machtou</b>	Root-canal Pluggers	B13
<b>Markley</b>	Filling instruments - amalgam	F29
<b>Marquette</b>	Filling instruments - amalgam	F28
<b>Mathieu</b>	Needle holders	C16, C17, E5
<b>Mayo</b>	Gum scissors	C8
<b>Mayo-Hegar</b>	Needle holders	C12
	Needle holders - AsaLady	C12
<b>Mc Call</b>	Curettes and Scalers	G7
<b>Mc Kellops</b>	Wire forming pliers	H18
<b>Mead</b>	Extracting forceps	D24
	Bone rongeurs	D43
	Mallets	E16, G29
	Periosteals and Elevators	E24, G17
<b>Meriam</b>	Cotton and dressing pliers	B4
	Cotton and dressing pliers - AsaLady	B5
	Tweezers	K19
<b>Merrit</b>	Periodontal pocket Probes	G3
<b>Mershon</b>	Band pushers	H34
<b>Metzenbaum</b>	Gum scissors	C8
<b>Metzenbaum-Delikat</b>	Gum scissors	C8, E4
<b>Micro-Adson</b>	Tissue pliers	C38, C39
<b>Micro-Barraquer</b>	Needle holders	C17, E6
<b>Micro-Mosquito</b>	Hemostats	C22, F44
<b>Middeldorpf</b>	Retractors	C37, E12
<b>Miller</b>	Files	E21, G23
	Articulating paper forceps	F42
<b>Miller-Apexo</b>	Root elevators	D52, D60
<b>Mini-Crane-Kaplan</b>	Curettes and Scalers	G8
<b>Mini-Friedman</b>	Bone rongeurs	D42, E30
	Bone rongeurs	G30
	Root elevators	D57
<b>Mini-Ruskin</b>	Bone rongeurs	D44
<b>Mini Ryder</b>	Needle holders	C13
<b>Molt</b>	Mouth gags	C33
	Periosteals and Elevators	E23, G16
<b>Nabers</b>	Double ended Explorers	B11
<b>Nance</b>	Wire forming pliers	H11, H12, H15

scientific name	instrument type	page
<b>Neumann</b>	Gum scissors	C7
<b>Nevius</b>	Extracting forceps - American pattern	D27
	Extracting forceps - American pattern, AsaLady	D31
<b>New York University</b>	Filling instruments - Burnishers	F31
<b>Novatech</b>	Periodontal pocket Probes	G3
<b>Noyes (Castroviejo)</b>	Gum scissors	C7
<b>Ochsenbein</b>	Bone chisels and gouges	G27
	Chisels	G26
<b>Ogden-Felsch</b>	Extracting forceps	D19
<b>Olsen-Hegar</b>	Needle holders	C10
<b>Orban</b>	Medication instruments	F39
	Gingivectomy knives	G25
<b>Orringer</b>	Retractors - lip	E11
	Retractors - Tongue depressors	C34
<b>Partsch</b>	Bone chisels and gouges	G28
	Mallets	E16, G29
	Periosteals and Elevators	E24, G17
<b>Pean</b>	Hemostats	C20
<b>Perry</b>	Cotton and dressing pliers	B4
<b>Physick</b>	Extracting forceps - American pattern	D25
	Extracting forceps - American pattern, AsaLady	D29
<b>P.K. Thomas</b>	Wax and modelling carvers	K17
<b>Polokoff</b>	Files	G23
<b>Pott</b>	Root elevators	D63
<b>Prichard</b>	Periosteals and Elevators	E23, G16
<b>Quinby</b>	Gum scissors	C5
<b>Reynolds</b>	Wire forming pliers	H16
<b>Rhein</b>	Single ended Explorers	B6
<b>Rhodes</b>	Chisels	G26
<b>Roach</b>	Wax and modelling carvers	K16
<b>Roser-Koenig</b>	Mouth gags	C33
<b>Routurier</b>	Extracting forceps	D6, D7, D16
<b>Rule</b>	Curettes and Scalers	G5
<b>Sanders</b>	Gingivectomy knives	G25
<b>Schaedle</b>	Towel clamps	C31
<b>Schilder</b>	Root-canal Pluggers	B14
<b>Schluger</b>	Files	G22
<b>Schmeckebier-Apexo</b>	Root elevators	D49, D59
<b>Schwarz</b>	Wire forming pliers	H25
<b>Seldin</b>	Root elevators	D52, D53, D54, D60
	Periosteals and Elevators	E25, G18
<b>Semken-Taylor</b>	Tissue pliers	C41, E36

scientific name	instrument type	page
<b>Senn-Miller</b>	Retractors	C35
<b>Schaedle</b>	Towel clamps	C31
<b>Spencer</b>	Gum scissors	C8
<b>SS. White</b>	Excavators	F16
<b>Sternberg</b>	Retractors	E11
	Tongue depressors	C34
<b>Stevens</b>	Gum scissors	C9
<b>Stieglitz</b>	Forceps for silver cones	B16
	Extracting forceps for root splinters	D41
<b>Stoke</b>	Clamp forceps	F9
<b>Stout</b>	Root elevators	D53
<b>Sugarman</b>	Files	G22
<b>Sullivan</b>	Gum scissors	C6
<b>Tanner</b>	Filling instruments - amalgam	F28
<b>Taylor</b>	Curettes and Scalers	G8
<b>Toennis</b>	Needle holders	C14
<b>Tofflemire</b>	Matrix retainers	F46
	Matrix	F47
<b>Tomati</b>	Gum guillotine forceps	G30
<b>Tomes</b>	Extracting forceps - American pattern	D27
	Extracting forceps - American pattern, AsaLady	D31
<b>Towner</b>	Scalers	G14
<b>Towner</b>	Scalers	G14
<b>Jacquette</b>		
<b>Townley</b>	Calipers	K30
<b>Trotter</b>	Extracting forceps	D17, D19, D20
<b>Tweed</b>	Wire forming pliers	H12, H13, H14, H15
<b>University of Michigan</b>	Combination Explorers - Probes	B10
	Periodontal pocket Probes	G3
<b>University of Minnesota</b>	Retractors	E12
	Tongue depressors	C34
<b>USC Towner (University of South California)</b>	Amalgam carvers	F37
	Gingivectomy knives	G25
	Wax and modelling carvers	K13
<b>Vickers</b>	Mallets	G29
<b>Vehe</b>	Wax and modelling carvers	K16
<b>Wahl</b>	Files	G23
<b>Wakefield</b>	Bone chisels and gouges	G27
<b>Walter F. Barry</b>	Root elevators	D61
<b>Waldsachs</b>	Wire forming pliers	H11
<b>Ward</b>	Filling instruments - amalgam	F28

scientific name	instrument type	page
	Amalgam carvers	F36
	Wax and modelling carvers	K13
<b>Warwick-James</b>	Root-tip picks	D64
<b>Wedelstaet</b>	Cavity preparation instruments - chisels	F18
<b>Weingart</b>	Utility pliers	H29
<b>Westcott</b>	Filling instruments - amalgam	F25
	Filling instruments - Burnishers	F31
	Gum scissors	C7
<b>White</b>	Extracting forceps	D17
<b>Wiland</b>	Amalgam carvers	F37
<b>Williams</b>	Combination Explorers - Probes	B10, B11
	Periodontal pocket Probes	G3
<b>Williger</b>	Bone curettes	G21
	Periosteals and Elevators	E25, G19
	Retractors	C35
<b>Winter</b>	Root elevators	D62
<b>Witzel</b>	Extracting forceps for roots	D40
<b>Woodson</b>	Filling instruments - plastic	F35
<b>Woodward</b>	Root elevators	D56
<b>Young</b>	Tongue forceps	C33
	Wire forming pliers	H14
<b>Younger-Good</b>	Curettes and Scalers	G8
<b>Zahle</b>	Wax and modelling carvers	K15, K16
<b>Zerfing-Chisel</b>	Curettes and Scalers	G4



**1**  
**A**

# ASAONE DISPOSABLES

MADE IN ITALY

## DENTISTS' FIRST CHOICE FOR DISPOSABLE PROFESSIONAL PRODUCTS

Asa Dental applied to an entire product family the same design and production efficiency that made its saliva ejectors the world best seller in the category. The result is AsaOne, the disposable product line designed for protection and comfort of dental professionals and their patients. Safe materials and innovative design meet color and shape to turn every dental practice into a welcoming place where best results are achieved.

**ASA  
ONE**

- A2 Saliva ejectors
- A6 Napkins
- A8 Dappen dishes
- A10 Plastic trays
- A12 Cotton rolls
- A13 Sterilization rolls
- A14 Face masks
- A15 Examination gloves
- A18 Sterilization pouches
- A19 Bibs
- A20 Accessories

Mint-scented saliva ejectors - AsaFresh



Soft-tip saliva ejectors - Total-Comfort



REMOVABLE TIP  
100 pcs / polybag  
10 polybags / carton  
1000 pcs

2908E-AT13/15  
blue tube  
transparent tip  
2908E-TT13/T15  
transparent tube  
transparent tip  
2908E-VT13/15  
green tube  
transparent tip



150 mm  
2908E-AT15  
130 mm  
2908E-AT13



150 mm  
2908E-TT15  
130 mm  
2908E-TT13



150 mm  
2908E-VT15  
130 mm  
2908E-VT13

REMOVABLE TIP  
100 pcs / polybag  
10 polybags / carton  
1000 pcs

2903E-BA155  
white tube  
blue tip  
2903E-BT155  
white tube  
transparent tip  
2903E-TA155  
transparent tube  
blue tip  
2903E-TT155  
transparent tube  
transparent tip



155 mm  
2903E-BA155



155 mm  
2903E-BT155



155 mm  
2903E-TA155



155 mm  
2903E-TT155

BONDED TIP  
100 pcs / polybag  
10 polybags / carton  
1000 pcs

2908E-BBS15  
white tube  
white tip  
2908E-TCS15  
transparent tube  
light-blue tip  
2908E-TTS15  
transparent tube  
transparent tip  
2908E-VTS15  
green tube  
transparent tip



150 mm  
2908E-BBS15



150 mm  
2908E-TCS15



150 mm  
2908E-TTS15



150 mm  
2908E-VTS15

BONDED TIP  
100 pcs / polybag  
10 polybags / carton  
1000 pcs

2903E-BAS155  
white tube  
blue tip  
2903E-BTS155  
white tube  
transparent tip  
2903E-TAS155  
transparent tube  
blue tip  
2903E-TTS155  
transparent tube  
transparent tip



155 mm  
2903E-BAS155



155 mm  
2903E-BTS155



155 mm  
2903E-TAS155



155 mm  
2903E-TTS155

Multi-color saliva ejectors



Multi-color saliva ejectors



REMOVABLE TIP  
2900E  
100 pcs / polybag  
10 polybags / carton  
1000 pcs

2900E-AT13/15  
blue tube  
transparent tip  
2900E-TT13/15  
transparent tube  
transparent tip  
2900E-VT13/15  
green tube  
transparent tip  
2900E-BT13/15  
white tube  
transparent tip  
2900E-GT13/15  
yellow tube  
transparent tip  
2900E-LT13/15  
lilac tube  
transparent tip

REMOVABLE TIP  
2901E  
250 pcs / polybag  
20 polybags / carton  
5000 pcs

2901E-AT13/15  
blue tube  
transparent tip  
2901E-TT13/T15  
transparent tube  
transparent tip  
2901E-VT13/15  
green tube  
transparent tip



150 mm  
2900E-AT15  
2901E-AT15  
130 mm  
2900E-AT13  
2901E-AT13



150 mm  
2900E-TT15  
2901E-TT15  
130 mm  
2900E-TT13  
2901E-TT13



150 mm  
2900E-VT15  
2901E-VT15  
130 mm  
2900E-VT13  
2901E-VT13



150 mm  
2900E-OT15  
130 mm  
2900E-OT13



150 mm  
2900E-RT15  
130 mm  
2900E-RT13



150 mm  
2900E-ZT15  
130 mm  
2900E-ZT13

REMOVABLE TIP  
100 pcs / polybag  
10 polybags / carton  
1000 pcs

2900E-OT13/15  
orange tube  
transparent tip  
2900E-RT13/15  
red tube  
transparent tip  
2900E-ZT13/15  
cyan tube  
transparent tip

BONDED TIP  
100 pcs / polybag  
10 polybags / carton  
1000 pcs

2900E-ATS15  
blue tube  
transparent tip  
2900E-BBS15  
white tube  
white tip  
2900E-TCS15  
transparent tube  
light-blue tip  
2900E-TTS15  
transparent tube  
transparent tip  
2900E-VTS15  
green tube  
transparent tip



150 mm  
2900E-BT15  
130 mm  
2900E-BT13



150 mm  
2900E-GT15  
130 mm  
2900E-GT13



150 mm  
2900E-LT15  
130 mm  
2900E-LT13



150 mm  
2900E-ATS15



150 mm  
2900E-BBS15



150 mm  
2900E-TCS15



150 mm  
2900E-TTS15



150 mm  
2900E-VTS15

Napkins - AsaRainbow



Napkins - AsaRainbow



**Lilac**  
3510-L  
3511-L



**Lime**  
3510-LI  
3511-LI

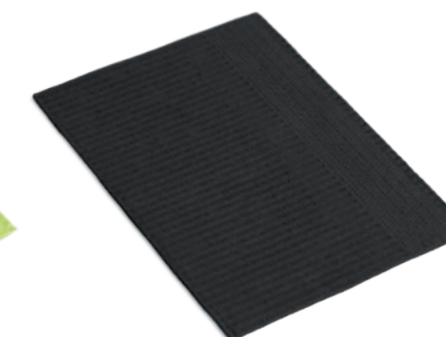

**Black**  
3510-N  
3511-N

33x45 cm  
three-ply paper

3510  
carton of 500 pcs

3511  
available on request  
50 pcs / pack  
10 packs / carton  
500 pcs



**White**  
3510-B  
3511-B



**Burgundy**  
3510-BX  
3511-BX



**Orange**  
3510-O  
3511-O



**Pink**  
3510-P  
3511-P



**Peach**  
3510-PE  
3511-PE

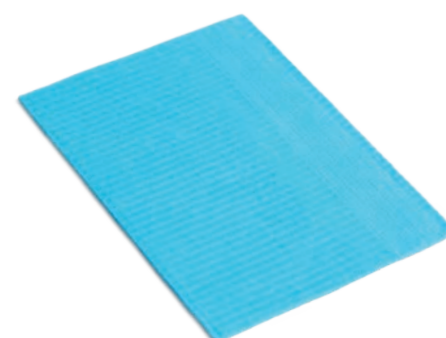

**Light blue**  
3510-C  
3511-C

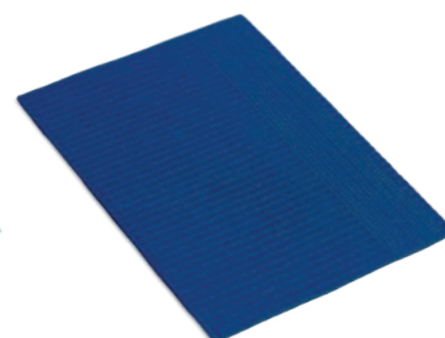

**Dark blue**  
3510-D  
3511-D



**Yellow**  
3510-G  
3511-G



**Green**  
3510-V  
3511-V



3200  
patient bib chain

Dappen dishes



50 pcs / pack  
5 packs per color / carton  
1000 pcs



Yellow + Red + White + Blue  
3700-MX

Dappen dishes

50 pcs / pack  
20 packs / carton  
1000 pcs



Black  
3700-N



Yellow  
3700-G



Blue  
3700-C



White  
3700-B



Red  
3700-R

**Plastic trays**

281x183x17 mm



**White smooth**  
AL2727-1



**White knurled**  
AL2727-1Z

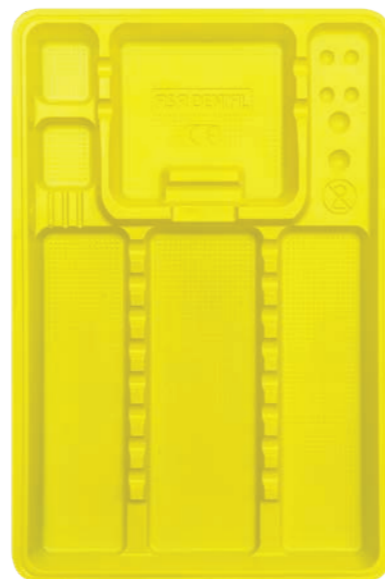

**Yellow knurled**  
AL2727-1GZ



**Blue knurled**  
AL2727-1AZ



**Teal-green knurled**  
AL2727-1CZ

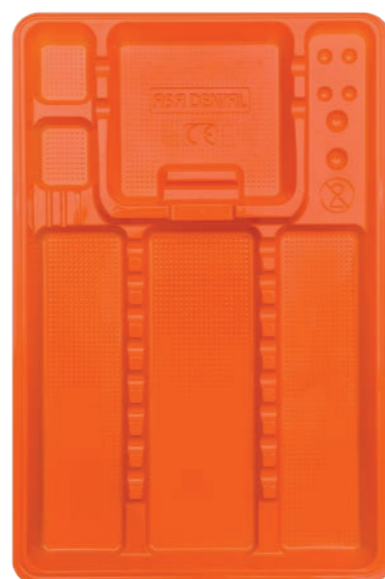

**Orange knurled**  
AL2727-1OZ

**Plastic trays**

183x140x17 mm



**White smooth**  
AL2727-2

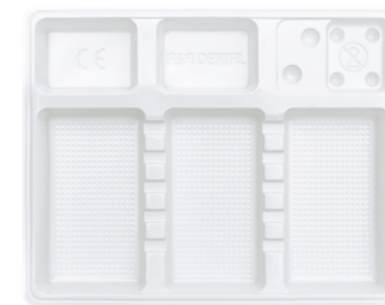

**White knurled**  
AL2727-2Z



**Yellow knurled**  
AL2727-2GZ



**Blue knurled**  
AL2727-2AZ

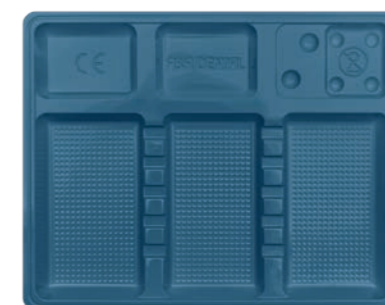

**Teal-green knurled**  
AL2727-2CZ



**Orange knurled**  
AL2727-2OZ

200x150 mm  
400 pcs / box



**White smooth**  
AL2738-1

**White smooth**  
AL2738-2

200x100 mm  
400 pcs / box

**Cotton rolls**

100% cotton  
300 gr. / polybag  
20 polybags / carton

16800 pcs / carton

Ø 8 mm | 840 pcs  
3520-1



12000 pcs / carton

Ø 10 mm | 600 pcs  
3520-2



9000 pcs / carton

Ø 12 mm | 450 pcs  
3520-3

**Sterilization rolls**

one ply of paper and one ply of polypropylene  
with sterilization process indicator

8 pcs / carton

50 mm x 200 mt  
3400E-55

75 mm x 200 mt  
3400E-75

4 pcs / carton

100 mm x 200 mt  
3400E-100

150 mm x 200 mt  
3400E-150

2 pcs / carton

200 mm x 200 mt  
3400E-200

250 mm x 200 mt  
3400E-250

1 pc / carton

300 mm x 200 mt  
3400-300



**Surgical face masks**

high quality materials  
nonwoven  
hypoallergenic  
without fibreglass  
level of B.F.E. 99.7%  
50 pcs / box  
6 boxes / carton  
300 pcs

earloop face masks

**White**

3450E-B

**Light blue**

3450E-C

**Pink**

3450E-R

**Green**

3450E-V



Happy Kid  
earloop face masks

**Blue**

3450E-HC

**Pink**

3450E-HR

**Examination gloves**

latex  
ambidextrous  
non-sterile  
100 gloves / box  
10 boxes/ carton  
1000 pcs

powder- and cornstarch-free  
hypoallergenic

**Extra small (5-6)**

3301E-XS

**Small (6-7)**

3301E-S

**Medium (7-8)**

3301E-M

**Large (8-9)**

3301E-L



low powder

**Extra small (5-6)**

3303E-XS

**Small (6-7)**

3303E-S

**Medium (7-8)**

3303E-M

**Large (8-9)**

3303E-L



knurled  
with powder  
green

**Extra small (5-6)**

3305-XS

**Small (6-7)**

3305-S

**Medium (7-8)**

3305-M

**Large (8-9)**

3305-L



**Examination gloves**

nitrile  
 powder and latex free  
 finger-textured  
 ambidextrous  
 non-sterile  
 240 mm  
 AQL 1.5  
 100 gloves / box  
 10 boxes / carton  
 1000 pcs

**Blue**

**Extra small (5-6)**  
 3309E-XS

**Small (6-7)**  
 3309E-S

**Medium (7-8)**  
 3309E-M

**Large (8-9)**  
 3309E-L

**White**

**Extra small (5-6)**  
 3310E-XS

**Small (6-7)**  
 3310E-S

**Medium (7-8)**  
 3310E-M

**Large (8-9)**  
 3310E-L

**Examination gloves****Cornflower blue**

**Extra small (5-6)**  
 3313E-XS

**Small (6-7)**  
 3313E-S

**Medium (7-8)**  
 3313E-M

**Large (8-9)**  
 3313E-L

**Light purple**

**Extra small (5-6)**  
 3314E-XS

**Small (6-7)**  
 3314E-S

**Medium (7-8)**  
 3314E-M

**Large (8-9)**  
 3314E-L

**Green**

**Extra small (5-6)**  
 3311E-XS

**Small (6-7)**  
 3311E-S

**Medium (7-8)**  
 3311E-M

**Large (8-9)**  
 3311E-L

**Teal blue**

**Extra small (5-6)**  
 3312E-XS

**Small (6-7)**  
 3312E-S

**Medium (7-8)**  
 3312E-M

**Large (8-9)**  
 3312E-L

**Pink**

**Extra small (5-6)**  
 3315E-XS

**Small (6-7)**  
 3315E-S

**Medium (7-8)**  
 3315E-M

**Large (8-9)**  
 3315E-L

**Black**

**Extra small (5-6)**  
 3316E-XS

**Small (6-7)**  
 3316E-S

**Medium (7-8)**  
 3316E-M

**Large (8-9)**  
 3316E-L



**Sterilization pouches**

self-sealing pouches

200 pcs / box  
12 boxes / carton  
2400 pcs



**75x250 mm**  
3403-75



**90x230 mm**  
3403-90

200 pcs / box  
8 boxes / carton  
1600 pcs



**140x250 mm**  
3403-140

**Bibs**

tear off rolls  
waterproof  
two-ply polyethylene and paper

**3251E**  
53x60 cm  
80 bibs  
9-roll / carton

**3252E**  
53x80 cm  
60 bibs  
9-roll / carton



**White**  
3251E-B/9  
3252E-B/9



**Light blue**  
3251E-C/9  
3252E-C/9



**Dark blue**  
3251E-D/9  
3252E-D/9

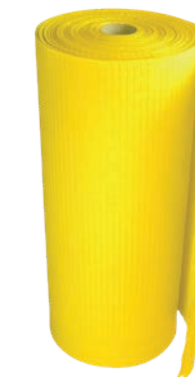

**Yellow**  
3251E-G/9  
3252E-G/9



**Lilac**  
3251E-L/9  
3252E-L/9



**Lime**  
3251E-LI/9  
3252E-LI/9



**Orange**  
3251E-O/9  
3252E-O/9



**Green**  
3251E-V/9  
3252E-V/9

**Cups**



200 cc  
100 pcs / bag  
30 bags / carton  
3000 pcs



**White**  
3818-B

**Plastic mixing spatulas**

100 pcs / package



AL2736

**Mixing trays**

70x54x6 mm  
12 wells each  
1000 pcs / package



AL2735

**Drinking cup dispensers**

85 x 85 x 360 mm  
up to a maximum of 70 cups



**Silver**  
2750-1



**White**  
2750-2

**Plastic syringes**

for elastomers  
50 pcs / box  
10 boxes / carton  
500 pcs



3710

**Used needle holder**

plastic box



AL2766

**First examination instruments kit**

non-sterile  
content:  
2100-M  
0700-M  
0601-M



S0600-M

**Waste container**

1000 pcs / box



AL2767-1

aluminium base  
for waste containers



AL2767-2

**Synthetic instant ice**

14x18 cm  
non woven bag  
temperature -4°C  
25 bags / carton



3600E

**Disposable plastic impression trays**

24 pcs / pack

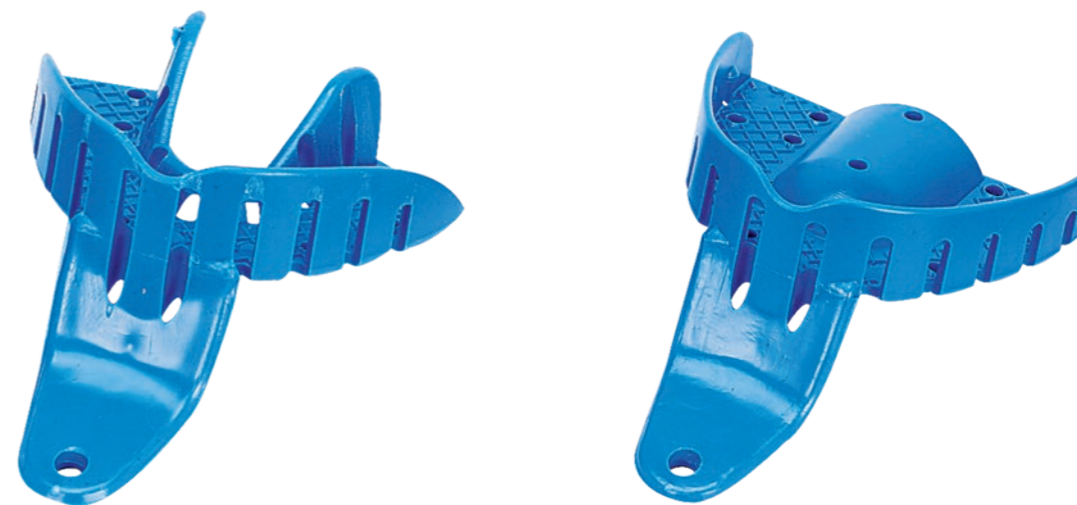

12 lower + 12 upper



1  
2853E-1

2  
2853E-2



3  
2853E-3

4  
2853E-4

12 partial right + 12 partial left



1  
2853E-1DS

2  
2853E-2DS

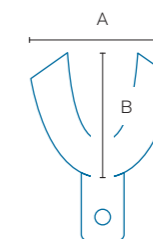

LOWER	A (mm)	B (mm)
1	61	50
2	67	52
3	72	56
4	74	58

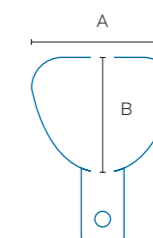

UPPER	A (mm)	B (mm)
1	61	49
2	65	53
3	70	59
4	73	63

**2**  
**B**

## DIAGNOSTIC

MADE IN ITALY

### EMPOWERING DENTISTS TO MAKE PRECISE AND ACTIONABLE DIAGNOSIS

The ultimate goal of dental care is to assist in the lifelong maintenance of a dentition that is functional, comfortable and aesthetically pleasant. It all starts with a reliable diagnosis that can be clearly and effectively communicated to the patient. For this reason, we designed our diagnostic instruments selecting those materials offering the ideal trade-offs between precision, elasticity, ergonomics and durability, with different emphasis depending on the scope of the tool.

- B3 Pocket markers
- B3 Cotton and dressing pliers
- B5 Explorers
- B10 Combination Explorers - Probes
- B12 Spreaders
- B13 Pluggers
- B15 Vertical condensers
- B15 Excavators
- B16 Endodontic instruments
- B17 Mirrors
- B21 Ultralight Retractor
- B22 Kits

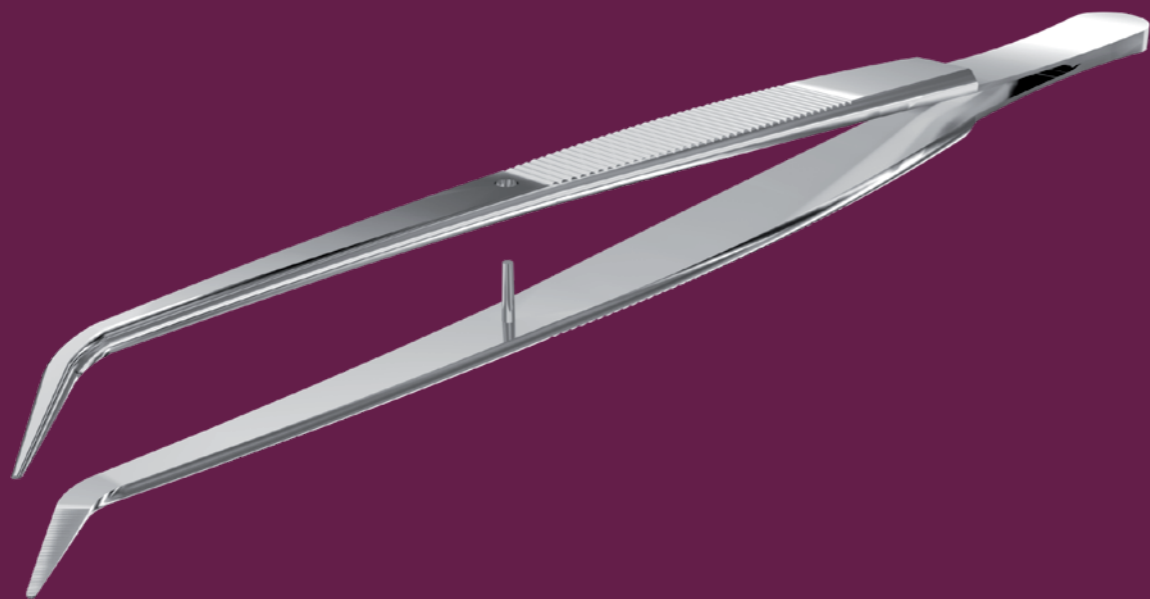

Handle options

SINGLE END

- Asa60  
(stainless steel)  
ø 6.0 mm
- Asa60M  
(stainless steel, single-piece)  
ø 6.0 mm
- Leonardo ML  
(stainless steel)  
ø 7.0 mm
- Alu80  
(aluminum, hollow)  
ø 8.0 mm
- Magic Color MC  
(aluminum core and non-slip plastic)  
ø 8.0 / 10.5 mm



DOUBLE END

- Asa60  
(stainless steel)  
ø 6.0 mm
- Asa Light MV  
(stainless steel, hollow)  
ø 8.0 mm
- Leonardo ML  
(stainless steel)  
ø 7.0 mm
- Magic Color MC  
(aluminum core and non-slip plastic)  
ø 8.0 / 10.5 mm

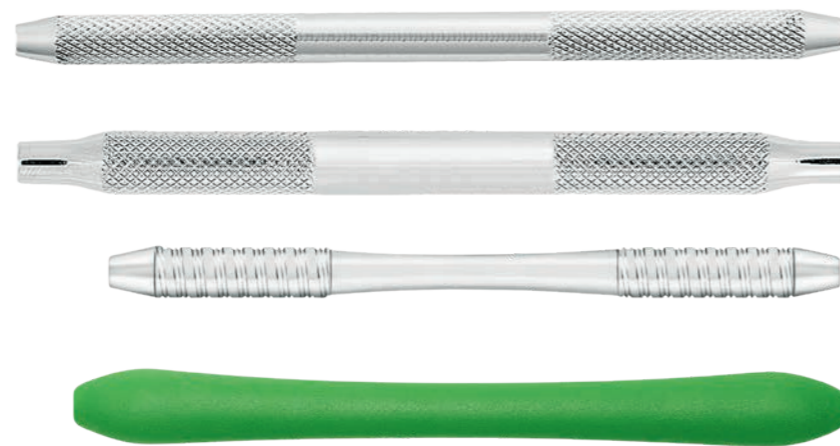

How to use

- 3R Rhein → pattern + scientific name
- 0700-3R → Asa Dental code
- Asa60 → handle option

AsaLady

- products ergonomically designed for women hands:
- smaller and lighter handles
  - smaller finger holes
  - reduced size
  - code starts with "W" or "SW"

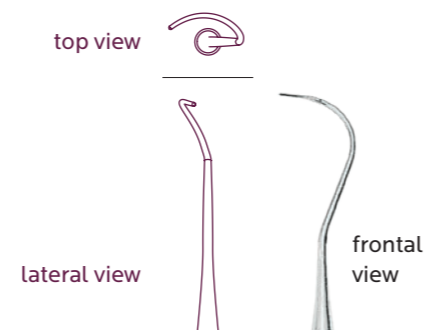
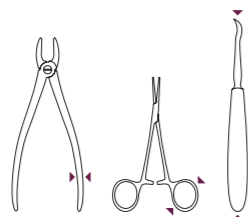

Periodontal pocket markers



1 (Crane-Kaplan)  
Goldman-Fox  
15 cm  
0650-1

2 (Crane-Kaplan)  
Goldman-Fox  
15 cm  
0650-2

Cotton and dressing pliers  
self-locking



18L Locking  
16 cm  
0600-18L

1  
15 cm  
0602-1

2  
15 cm  
0602-2

Cotton and dressing pliers

set of 5



1 Flag  
S0601-1



2 London-College  
S0601-2



3 Meriam  
S0601-3

Cotton and dressing pliers



0600-2  
Antimagnetic and easy to clean, these pliers are comfortably light and efficiently durable. Shape and angles make them ideal for any situations, even the most complicated. Thanks to an anti-adherent coating, they can be used to place temporary filling materials.



1 Flag 15 cm 0601-1	2 London-College 15 cm 0601-2	3 Meriam 16 cm 0601-3	4 Perry 13 cm 0601-4	5 Perry 13 cm 0601-5	4 Perry 13 cm 0600-4	2 London-College 16 cm 0600-2	3 16 cm 0600-3	17 16 cm 0600-17	18 16 cm 0600-18	19 16.5 cm 0600-19	1 Flag 14 cm W0610-1	2 London College 14 cm W0610-2	3 Meriam 15 cm W0610-3
---------------------------	-------------------------------------	-----------------------------	----------------------------	----------------------------	----------------------------	-------------------------------------	----------------------	------------------------	------------------------	--------------------------	----------------------------	--------------------------------------	------------------------------

Single ended Explorers



**2**  
0700-2  
Asa60  
0701-2  
Asa60M



**3**  
0700-3  
Asa60  
0701-3  
Asa60M



**3A**  
0700-3A  
Asa60  
0701-3A  
Asa60M



**3R Rhein**  
0700-3R  
Asa60  
ML0700-3R  
Leonardo ML



**5**  
0700-5  
Asa60  
0701-5  
Asa60M



**6**  
0700-6  
Asa60  
0701-6  
Asa60M  
ML0700-6  
Leonardo ML  
MC0700-6  
● Magic Color MC



**8**  
0700-8  
Asa60  
0701-8  
Asa60M  
ML0700-8  
Leonardo ML



**9**  
0700-9  
Asa60  
0701-9  
Asa60M  
ML0700-9  
Leonardo ML  
MC0700-9  
● Magic Color MC



**10**  
0700-10  
Asa60  
0701-10  
Asa60M



**11**  
0700-11  
Asa60  
0701-11  
Asa60M



**12**  
0700-12  
Asa60  
0701-12  
Asa60M



**16**  
0700-16  
Asa60  
0701-16  
Asa60M



**17**  
0700-17  
Asa60  
0701-17  
Asa60M  
ML0700-17  
Leonardo ML



**17A**  
0700-17A  
Asa60  
0701-17A  
Asa60M



**23**  
0700-23  
Asa60  
0701-23  
Asa60M  
ML0700-23  
Leonardo ML  
MC0700-23  
● Magic Color MC

Single ended Explorers



**0700-23**  
Designed for outstanding ergonomics, they are perfect for cavity diagnostic. The ideal trade-off between sharpness and flexibility ensures investigation of minimal filling fissures and excess, as well as confirmation of optimal occlusion when fixed dental prosthetics demand for uncompromised precision.

set of 5  
Asa60



**6**  
S0700-6



**9**  
S0700-9



**11**  
S0700-11



**16**  
S0700-16



**23**  
S0700-23

Double ended Explorers

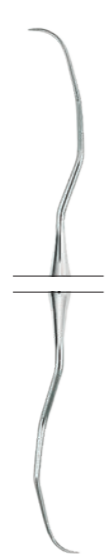

**11/12AF**  
0704-11/12AF  
Asa60  
ML0704-11/12AF  
Leonardo ML  
MC0704-11/12AF  
● Magic Color MC

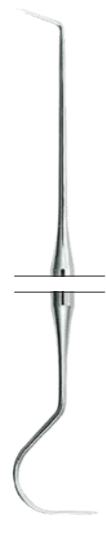

**16/23**  
0704-16D1  
Asa60  
MV0704-16D1  
Asa Light MV

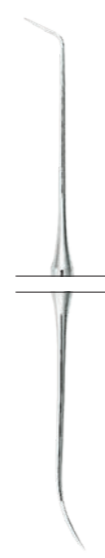

**16/3**  
0704-16D2  
Asa60  
MV0704-16D2  
Asa Light MV

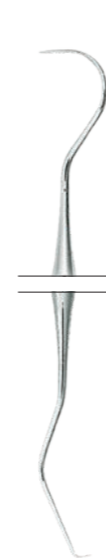

**23/17**  
0704-23D1  
Asa60  
MV0704-23D1  
Asa Light MV  
ML0704-23D1  
Leonardo ML  
MC0704-23D1  
● Magic Color MC

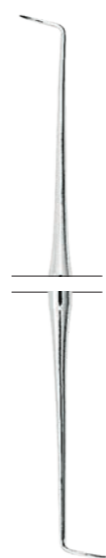

**3**  
0709-3  
Asa60  
MV0709-3  
Asa Light MV

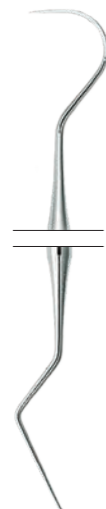

**6/9**  
0704-6D9  
Asa60  
ML0704-6D9  
Leonardo ML  
MC0704-6D9  
● Magic Color MC

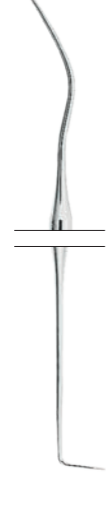

**23/17A**  
0704-23D2  
Asa60  
MV0704-23D2  
Asa Light MV



**UT 1/2 Cattoni**  
0704-UT1  
Asa60  
MV0704-UT1  
Asa Light MV

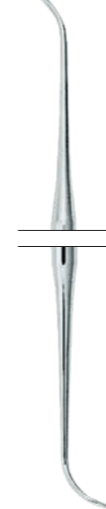

**2**  
0709-2  
Asa60  
MV0709-2  
Asa Light MV

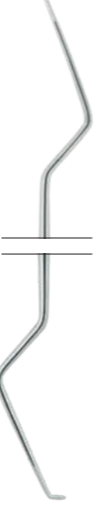

**2A**  
0709-2A  
Asa60  
MV0709-2A  
Asa Light MV

Double ended Explorers

Root-canal Explorers

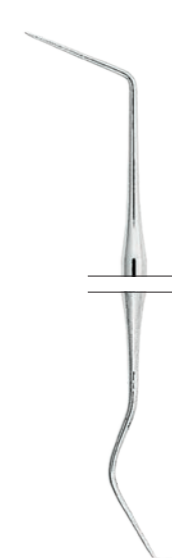

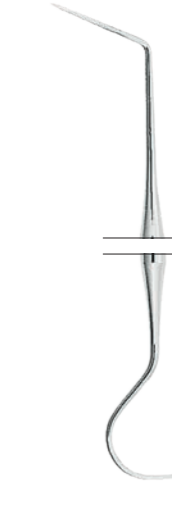

**6/17**  
0710-6D2  
Asa60  
MV0710-6D2  
Asa Light MV



**6/1**  
0710-6D1  
Asa60  
MV0710-6D1  
Asa Light MV

**6/23**  
0710-6D3  
Asa60  
MV0710-6D3  
Asa Light MV

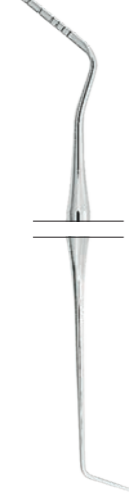
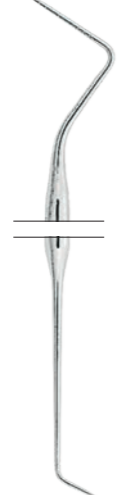
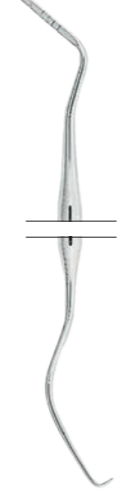
Combination Explorers - Probes

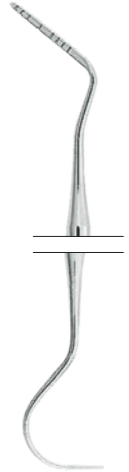
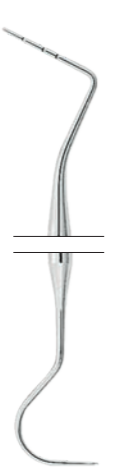
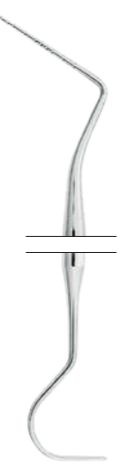
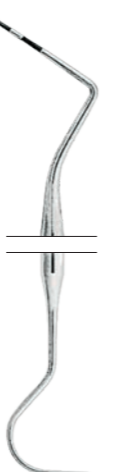
1 2 3 5 7 8 9 10 FLAT TIP	1 2 3 5 7 8 9 10 FLAT TIP	1 2 3 5 7 8 9 10	1 2 3 5 7 8 9 10 FLAT TIP	3 6 8	1 2 3 5 7 8 9 10
					
<b>3</b> Goldman-Fox 0705L-3GF Asa60 MV0705-3GF Asa Light MV	<b>16</b> Goldman-Fox 0705L-16GF Asa60 MV0705-16GF Asa Light MV	<b>16</b> Williams 0705L-16W Asa60 MV0705-16W Asa Light MV	<b>17</b> Goldman-Fox 0705L-17GF Asa60 MV0705-17GF Asa Light MV	<b>17</b> University of Michigan 0705L-17UM Asa60 MV0705-17UM Asa Light MV	<b>17</b> Williams 0705L-17W Asa60 MV0705-17W Asa Light MV
1 2 3 5 7 8 9 10 FLAT TIP	3 6 8	1 2 3 5 7 8 9 10 12 14	3 6 8 11	3 6 9 12	
					
<b>23</b> Goldman-Fox 0705L-23GF Asa60 MV0705-23GF Asa Light MV	<b>23</b> University of Michigan 0705L-23UM Asa60 MV0705-23UM Asa Light MV	<b>23</b> Williams 0705L-23W Asa60 MV0705-23W Asa Light MV ML0705-23W Leonardo ML	<b>23/CP11</b> 0706L-2311 Asa60 MV0706-2311 Asa Light MV	<b>23/CP12</b> 0706L-2312 Asa60 MV0706-2312 Asa Light MV	

Double ended Explorers

1 2 3 5 7 8 9 10 FLAT TIP	3 6 9 12		
			
1 2 3 5 7 8 9 10	12 9 6 3		
<b>Goldman-Fox Williams</b> 0707L-GFW Asa60 MV0707-GFW Asa Light MV MC0707-GFW ● Magic Color MC	<b>2N Nabers</b> 0708L-2N Asa60	<b>1N Nabers</b> 0708-1N Asa60 MV0708-1N Asa Light MV	<b>2N Nabers</b> 0708-2N Asa60 MV0708-2N Asa Light MV ML0708-2N Leonardo ML MC0708-2N ● Magic Color MC

MV0707L-GFW



Root-canal Spreaders



0800-1  
ROOT CANAL INSTRUMENTS  
A special coating help tips work without any adherence issue in any condition, including those asking for extra pressure.

**1**  
0800-1  
Asa60  
ML0800-1  
Leonardo ML  
MC0800-1  
● Magic Color MC

**2**  
0800-2  
Asa60  
ML0800-2  
Leonardo ML  
MC0800-2  
● Magic Color MC

**3**  
0800-3  
Asa60  
ML0800-3  
Leonardo ML  
MC0800-3  
● Magic Color MC

**4**  
0800-4  
Asa60

**5**  
0800-5  
Asa60

**6**  
0800-6  
Asa60

**7**  
0800-7  
Asa60

Root-canal Pluggers

**1 Luks**  
0801-1  
Asa60

**2 Luks**  
0801-2  
Asa60

**3 Luks**  
0801-3  
Asa60

**4 Luks**  
0801-4  
Asa60

**1 Machtou**  
ML0803-1  
Leonardo ML  
MC0803-1  
● Magic Color MC

**2 Machtou**  
ML0803-2  
Leonardo ML  
MC0803-2  
● Magic Color MC

**3 Machtou**  
ML0803-3  
Leonardo ML  
MC0803-3  
● Magic Color MC

**4 Machtou**  
ML0803-4  
Leonardo ML  
MC0803-4  
● Magic Color MC

Root-canal Pluggers

Vertical condensers

Root-canal Excavators

Ø 0.30  
15 | 20

Ø 0.35  
10 | 15 | 20

Ø 0.40  
5 | 10 | 15 | 20

Ø 0.50  
5 | 10 | 15 | 20

Ø 0.60  
5 | 10 | 15 | 20

Ø 0.70  
5 | 10 | 15 | 20

Ø 0.80  
5 | 10 | 15 | 20

Ø 0.90  
5 | 10 | 15 | 20

Ø 1.05  
5 | 10 | 15 | 20

Ø 1.20  
5 | 10 | 15 | 20

**7 ½ Schilder**  
ML0802-1  
Leonardo ML

**8 Schilder**  
ML0802-2  
Leonardo ML  
MC0802-2  
● Magic Color MC

**8 ½ Schilder**  
ML0802-3  
Leonardo ML

**9 Schilder**  
ML0802-4  
Leonardo ML  
MC0802-4  
● Magic Color MC

**9 ½ Schilder**  
ML0802-5  
Leonardo ML

**10 Schilder**  
ML0802-6  
Leonardo ML  
MC0802-6  
● Magic Color MC

**10 Schilder**  
ML0802-7  
Leonardo ML

**11 Schilder**  
ML0802-8  
Leonardo ML

**11 ½ Schilder**  
ML0802-9  
Leonardo ML

**10 Schilder**  
ML0802-10  
Leonardo ML

Ø 0.5  
5 | 10 | 15 | 20

Ø 0.7  
5 | 10 | 15 | 20

Ø 0.9  
5 | 10 | 15 | 20

Ø 1.2

Ø 1.5

Ø 1.1  
5 | 10 | 15 | 20

Ø 2

**1**  
0802L-1  
Asa60

**2**  
0802L-2  
Asa60

**3**  
0802L-3  
Asa60

**31L**  
1709-31L  
Asa60  
MV1709-31L  
Asa Light MV

**32L**  
1709-32L  
Asa60  
MV1709-32L  
Asa Light MV

**33L**  
1709-33L  
Asa60  
MV1709-33L  
Asa Light MV

ENDODONTIC RULER  
0800

**Endodontic instruments**

Pliers for removing broken broaches



**1**  
13 cm  
0870-1



**2**  
13 cm  
0870-2

Forceps and pliers for silver cones



**1 Stieglitz**  
0102-1



**2 Stieglitz**  
0102-2

**Photographic Mirrors**

Occlusal surfaces

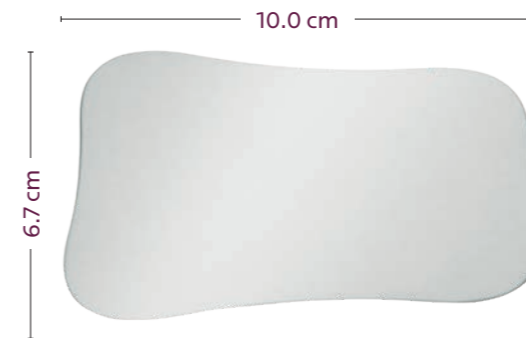

2250-1

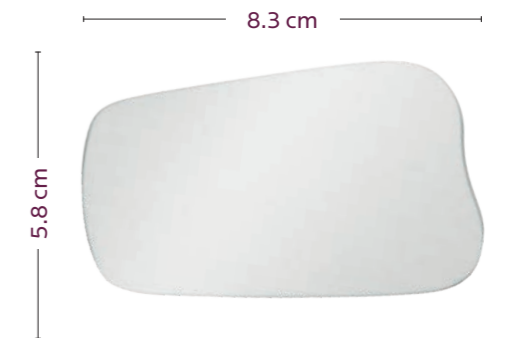

2250-2

Buccal surfaces



2250-3

Lingual surfaces

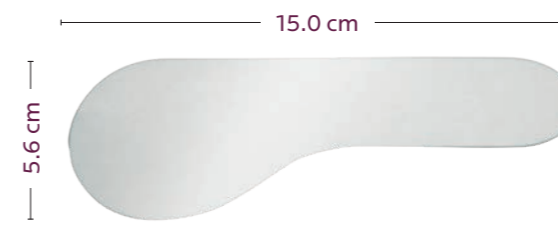

2250-4



2250-5

Simple stem Mouth Mirrors

box of 12



Simple stem Mouth Mirrors

single



parallelometer  
2002-6  
parallelometer + handle  
S2002-6  
Asa60

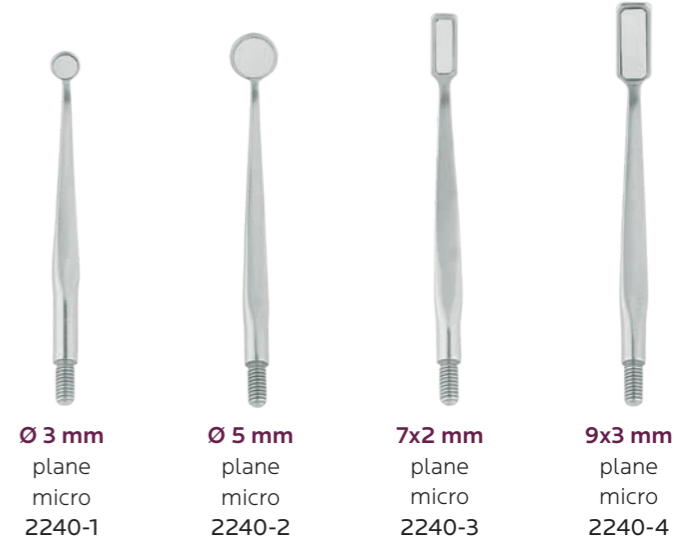

box of 12



Handles



S2100 Octagonal set of 5  
S2101 Asa60 set of 5  
S2102-IN Exagonal hollow set of 5  
ML2101 Leonardo ML  
2104-B ● Alu80  
2104-C ● Alu80  
2104-G ● Alu80  
2104-R ● Alu80  
2104-V ● Alu80  
MC2101-B ● Magic Color MC

box of 12



5  
Ø 22 mm  
plane  
2221-4



5  
Ø 24 mm  
plane  
2221-5

box of 6



5  
Ø 24 mm  
plane  
double sided  
2230-5

**Cone-socket Mouth Mirrors**

box of 12



**4**  
Ø 22 mm  
2210E-4  
plane

**5**  
Ø 24 mm  
2210E-5  
plane

**4**  
Ø 22 mm  
2211E-4  
magnifying

**5**  
Ø 24 mm  
2211E-5  
magnifying

box of 6



**5**  
Ø 24 mm  
plane  
double sided  
2231-5CS

**Handles**



2100-CS  
Octagonal

2101-CS  
Asa60

2102-CS  
Exagonal

**Ultralight Mirror**

technical data:  
Philips shockproof miniature  
lamps 2.25 V - 0.25 A  
2 x 1.5 V alkaline batteries AAA type

spare parts:  
0690-G o-ring  
0690-L lamp  
0690-M spring  
0690-T head with mandrel



**16 cm**  
0690



**Ultralight Retractor**

technical data:  
Philips shockproof miniature  
lamps 2.25 V - 0.25 A  
2 x 1.5 V alkaline batteries AAA type



**15 cm**  
0691



how to use the Ultralight Mirror and the Ultralight Retractor:

- insert 2 alkaline batteries
- take out the batteries prior to sterilization
- sterilizable O-ring on lamp to avoid penetration of saliva or liquid into the handle, thus preserving battery life
- easy light on/off through bottom cap
- no maintenance required for electrical or mechanical parts
- full disassembly for proper cleaning
- easy change of batteries and lamps
- ergonomic handle

Ultralight kit with mirror and retractor in a mini locking tray

content:  
0690 ultralight mirror  
0691 ultralight retractor  
2772-1 locking tray mini



S0690-2

**First examination instrument kit**



S0600-6

- content:
- 6 anatomic handle explorer 0700-6
  - 2 London-College cotton and dressing pliers 0601-2
  - anatomic mouth mirror handle 2101
  - 4 plane mouth mirror 2200-4

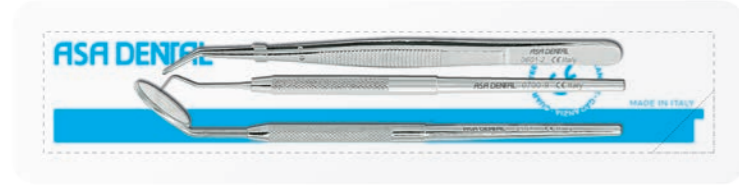

S0600-9

- content:
- 9 anatomic handle explorer 0700-9
  - 2 London-College cotton and dressing pliers 0601-2
  - anatomic mouth mirror handle 2101
  - 4 plane mouth mirror 2200-4



S0600-23

- content:
- 23 anatomic handle explorer 0700-23
  - 2 London-College cotton and dressing pliers 0601-2
  - anatomic mouth mirror handle 2101
  - 4 plane mouth mirror 2200-4

**First examination instrument kit - AsaLady**

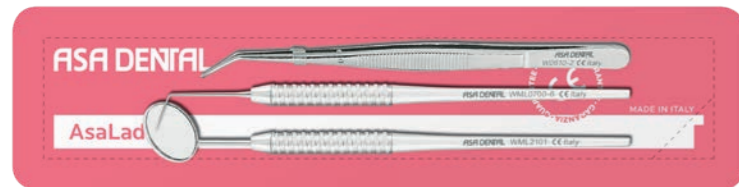

SWML0600-6

- content:
- 6 anatomic handle explorer WML0700-6
  - 2 London-College cotton and dressing pliers WML0610-2
  - Leonardo mouth mirror handle WML2101
  - 4 plane mouth mirror 2200-4

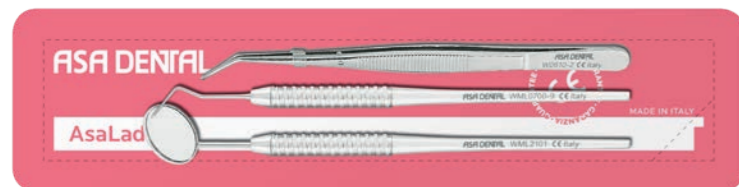

SWML0600-9

- content:
- 9 anatomic handle explorer WML0700-9
  - 2 London-College cotton and dressing pliers WML0610-2
  - Leonardo mouth mirror handle WML2101
  - 4 plane mouth mirror 2200-4

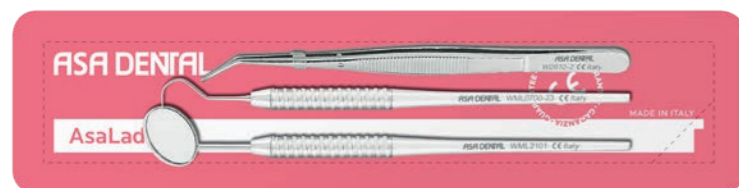

SWML0600-23

- content:
- 23 anatomic handle explorer WML0700-23
  - 2 London-College cotton and dressing pliers WML0610-2
  - Leonardo mouth mirror handle WML2101
  - 4 plane mouth mirror 2200-4

**First examination instrument kit - Magic Color**



SMC0600-6

- content:
- 6 Magic Color handle explorer MC0700-6
  - 2 London-College cotton and dressing pliers 0601-2
  - Magic Color mouth mirror handle MC2101-B
  - 4 plane mouth mirror 2200-4



SMC0600-9

- content:
- 9 Magic Color handle explorer MC0700-9
  - 2 London-College cotton and dressing pliers 0601-2
  - Magic Color mouth mirror handle MC2101-B
  - 4 plane mouth mirror 2200-4



SMC0600-23

- content:
- 23 Magic Color handle explorer MC0700-23
  - 2 London-College cotton and dressing pliers 0601-2
  - Magic Color mouth mirror handle MC2101-B
  - 4 plane mouth mirror 2200-4



**Magic Color instrument kit**

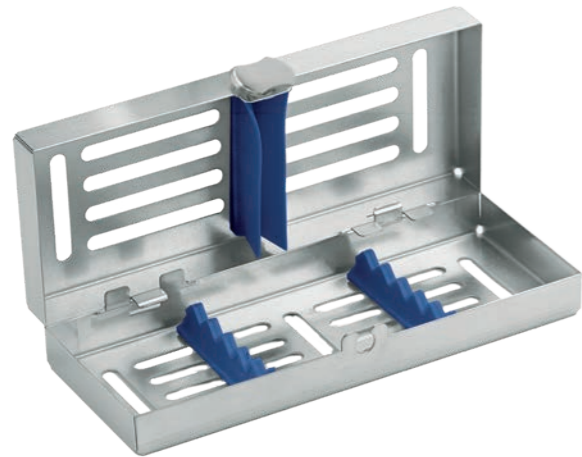

**Diagnostic instruments kit**  
SMC0700-5



	mouth mirror handle	MC2101-B
4	plane mouth mirror	2200-4
	Williams probe	MC0703-14
23/17	d/e explorer	MC0704-23D1
2	excavator	MC1700-2
2	London-College cotton and dressing pliers	0601-2
	mini locking tray	2772-1

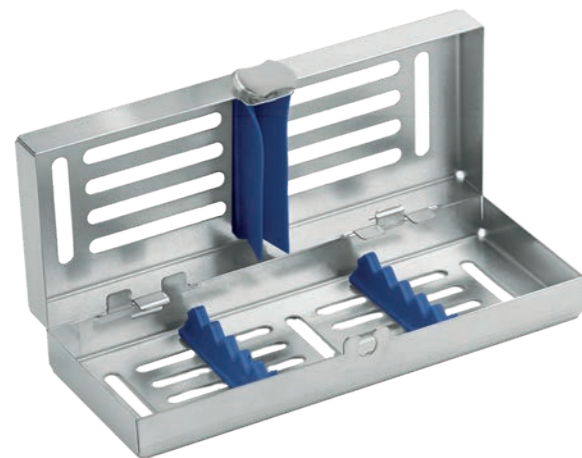

**Endodontic instruments kit**  
SMC0800-5



6/9	d/e explorer	MC0704-6D9
1	excavator	MC1700-1
1	spreader/plugger	MC0803-1
1/2	Hollenback	MC1500-02
2	London-College cotton and dressing pliers	0601-2
	mini locking tray	2772-1

**Endodontic kit**



**set**  
**7 Laser System instruments**  
S0702L-7



**Boston university**  
**set 23 instruments**  
S0702L-23



**Endodontic set**  
S0800

CP-12S	laser colour coded O.M.S periodontal pocket probe	0702L-12S
CP-12	laser colour coded periodontal pocket probe	0702L-12
	laser colour coded Williams explorer	0703L-1
	laser colour coded Goldman-Fox explorer	0703L-4
23/CP-12	combined laser colour coded explorer/probe	0706L-2312
1	laser colour coded vertical condenser	0802L-1
2	laser colour coded vertical condenser	0802L-2
	endodontic ruler	0800
	complete perforated instrument tray	S2702

2	London-College cotton and dressing pliers	0601-2
	anatomic mouth mirror handle	2101
4	plane mouth mirror	2200-4
	endodontic ruler	0800
23/17	Asa Light double ended explorer	MV0704-23D1
6/1	Asa Light root canal explorer	MV0710-6D1
16	Asa Light Williams combined explorer/probe	MV0705-16W
3	Asa Light Goldman-Fox combined explorer/probe	MV0705-3GF
CP-12S	laser colour coded O.M.S. periodontal pocket probe	0702L-12S
CP-12	laser colour coded periodontal pocket probe	0702L-12
CP-11	laser colour coded periodontal pocket probe	0702L-11
23/CP-12	laser colour coded combined explorer/probe	0706L-2312
1	spreader	0800-1
32L	Asa Light root canal excavator	MV1709-32L
19	Asa Light double ended excavator	MV1706-19
14	Asa Light double ended excavator	MV1703-14
1	Asa Light double ended excavator	MV1701-1
1/2	Asa Light Gracey curette	MV1807-02
3/4	Asa Light Gracey curette	MV1807-04
5/6	Asa Light Gracey curette	MV1807-06
7/8	Asa Light Gracey curette	MV1807-08
9/10	Asa Light Gracey curette	MV1807-10
11/12	Asa Light Gracey curette	MV1807-12
13/14	Asa Light Gracey curette	MV1807-14
	perforated instrument tray	S2721-2

CP-12S	laser colour coded O.M.S periodontal pocket probe	0702L-12S
CP-12	laser colour coded periodontal pocket probe	0702L-12
	laser colour coded Williams explorer	0703L-1
	laser colour coded Goldman-Fox explorer	0703L-4
23/CP-12	combined laser colour coded explorer/probe	0706L-2312
1	laser colour coded vertical condenser	0802L-1
2	laser colour coded vertical condenser	0802L-2
	endodontic ruler	0800
	complete perforated instrument tray	S2702



3  
C

# ORAL SURGERY

MADE IN ITALY

## ALL THE NECESSARY SURGICAL PRECISION

As a dental professional, you know that the more a procedure is invasive the clearer your communication with your patient must be. Answering questions like “How complicated it is?”, “How long will it take?” and “What could go wrong?” becomes as important as the intervention itself. Your job includes explaining the patient that the combination of your unique skills with the precision our instruments ensures the optimal outcome in the shortest time. We know that, and we answer the call of professionals like you asking for ergonomic instruments reliable over time and use that help reducing complexity and preventing complications.

- C3 Scissors
- C10 Needle holders
- C20 Hemostats
- C24 Scalpels
- C28 Syringes
- C31 Towel clamps
- C32 Dressing forceps
- C33 Mouth gags
- C33 Tongue forceps
- C34 Retractors
- C37 Antrum probes
- C38 Tissue pliers
- C44 Aspirators
- C45 Bone curettes
- C46 Kits

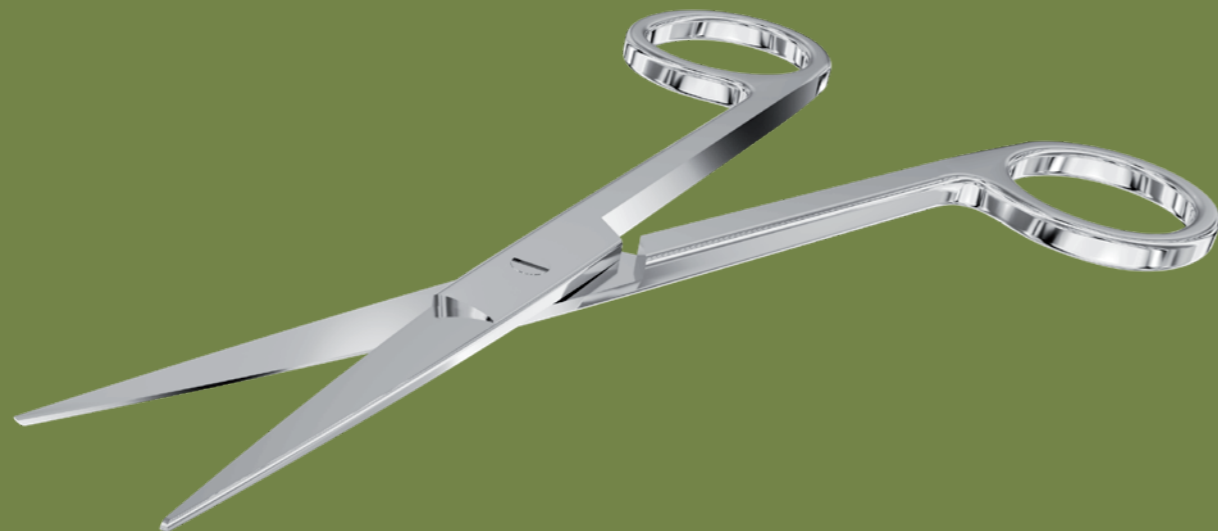

Handle options

DOUBLE END

Asa60  
(stainless steel)  
ø 6.0 mm

Asa Light MV  
(stainless steel, hollow)  
ø 8.0 mm

Leonardo ML  
(stainless steel)  
ø 7.0 mm

● Magic Color MC  
(aluminum core and  
non-slip plastic)  
ø 8.0 / 10.5 mm

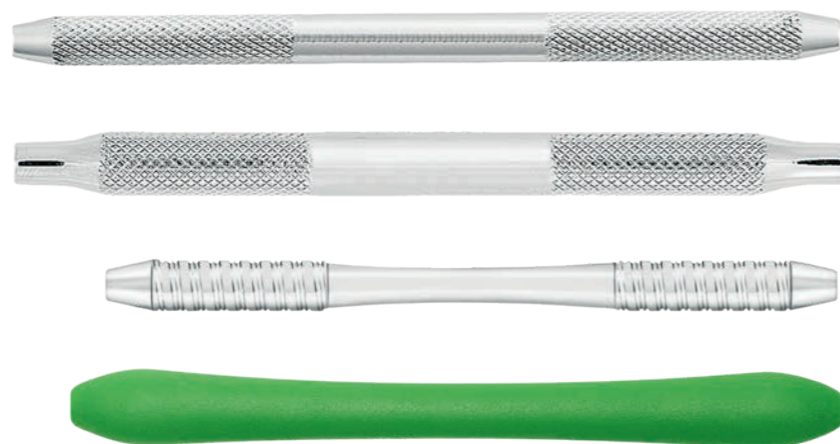

standard instrument



instrument with tungsten carbide (TC) inserts

How to use

- 1 Hemingway → pattern + scientific name
- MC2000-1 → Asa Dental code
- Magic Color MC → handle option

AsaLady

- products ergonomically designed for women hands:
- smaller and lighter handles
  - smaller finger holes
  - reduced size
  - code starts with "W" or "SW"

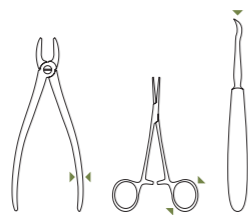

\* these products are not manufactured by Asa Dental and are distributed under manufacturer brand

Gum scissors



1  
straight  
12 cm  
0300-1



2  
curved  
12 cm  
0300-2



1  
straight  
12 cm  
W0319-1



2  
curved  
12 cm  
W0319-2



1  
angular  
11.5 cm  
0301-1



1  
angular  
one blade serrated  
11.5 cm  
0301-2



1 Goldman-Fox  
straight  
one blade serrated  
13 cm  
0304-1



2 Goldman-Fox  
curved  
one blade serrated  
13 cm  
0304-2

Gum scissors

Gum scissors



1 Iris  
straight  
11.5 cm  
0305-1



2 Iris  
curved  
11.5 cm  
0305-2



1TC Iris  
straight  
11 cm  
0305-1TC



2TC Iris  
straight  
11 cm  
0305-2TC



3 Iris  
curved  
11.5 cm  
0305-3



1 Quinby  
straight  
12.5 cm  
0308-1



2 Quinby  
curved  
12.5 cm  
0308-2



3 Goldman-Fox (special)  
curved  
one blade serrated  
13 cm  
0304-3



1TC Goldman-Fox  
straight  
13 cm  
0304-1TC



2TC Goldman-Fox  
curved  
13 cm  
0304-2TC



1TC Goldman-Fox  
curved  
17 cm  
0306-1TC



1 Kelly  
straight  
16 cm  
0309-1



2 Kelly  
curved  
16 cm  
0309-2



1TC Kelly  
straight  
16 cm  
0309-1TC



2TC Kelly  
curved  
16 cm  
0309-2TC

Gum scissors



1 Sullivan  
straight  
one blade serrated  
14.5 cm  
0311-1



2 Sullivan  
curved  
one blade serrated  
14.5 cm  
0311-2



1TC Locklin  
angular  
16.5 cm  
0310-1TC



1 Neumann  
curved  
12.5 cm  
0302-1



1 Dean  
curved  
one blade serrated  
17 cm  
0306-1



1 La Grange  
curved  
one blade serrated  
10.5 cm  
0307-1



1 Locklin  
angular  
one blade serrated  
16.5 cm  
0310-1



2 Locklin  
angular  
one blade serrated  
16.5 cm  
0310-2



2TC Locklin  
angular  
16.5 cm  
0310-2TC



1 Noyes (Castroviejo)  
curved  
very thin beaks  
12 cm  
0303-1



1 Westcott  
curved  
sharp beaks  
11 cm  
0312-1



2 Westcott  
curved  
blunt beaks  
11 cm  
0312-2



1  
curved  
very thin beaks  
14.5 cm  
0313-1

**Gum scissors**

suture scissors



1 Spencer  
9 cm  
0320-1



2 Spencer  
13 cm  
0320-2



1 Mayo  
straight  
14.5 cm  
0325-1



2 Mayo  
curved  
14.5 cm  
0325-2



Stevens  
straight  
11.5 cm  
0330-1



Stevens  
curved  
11.5 cm  
0330-2



Stevens  
rounded straight beaks  
11.5 cm  
0329-1

dissecting scissors



1 Metzenbaum  
straight  
14.5 cm  
0321-1



2 Metzenbaum  
curved  
14.5 cm  
0321-2



1 Metzenbaum-Delikat  
straight  
14.5 cm  
0322-1



2 Metzenbaum-Delikat  
curved  
14.5 cm  
0322-2



Stevens  
straight  
11.5 cm  
0328-1



Stevens  
curved  
11.5 cm  
0328-2



Stevens  
rounded curved beaks  
11.5 cm  
0329-2

Needle holders



Olsen-Hegar  
scissors combined  
14 cm  
0400-14



TC Olsen-Hegar  
14 cm  
0405-14TC



Baumgartner  
14.5 cm  
0404-14



TC Hegar-Baumgartner  
14 cm  
0409-14TC



Crile-Wood  
15 cm  
W0411-15

AsaLady



Crile-Wood  
15 cm  
0410-15



TC Crile-Wood  
15 cm  
0415-15TC



Adson  
17.5 cm  
0403-17



TC Crile-Wood  
15 cm  
W0411-15TC

AsaLady

0409-14TC



Needle holders



Mayo-Hegar  
16 cm  
0420-16



TC Mayo-Hegar  
16 cm  
0425-16TC



Mayo-Hegar  
16 cm  
W0412-16

Needle holders



Derf  
12 cm  
0401-12



TC Derf  
12 cm  
0406-12TC



TC Halsey-Smooth  
smooth jaws  
13 cm  
0407-13TC



Mayo-Hegar  
18 cm  
0420-18



TC Mayo-Hegar  
18 cm  
0425-18TC



TC Mayo-Hegar  
16 cm  
W0412-16TC



TC Mini-Ryder  
18 cm  
0416-18TC



TC Mini-Ryder  
15 cm  
0416-15TC



TC Halsey  
13 cm  
0408-13TC

Needle holders



Gillies  
scissors combined  
16 cm  
0414-16



TC Gillies  
scissors combined  
16 cm  
0419-16TC



TC Fine Swedish  
15 cm  
0417-15TC



Toennis  
light pattern  
18 cm  
0421-18



TC Toennis  
light pattern  
18 cm  
0426-18TC



TC Micro-Vascular  
15 cm  
0418-15TC

Needle holders



Lichtenberg  
smooth action  
17 cm  
0432-17



TC Lichtenberg  
17 cm  
0437-17TC



Eiselberg-Mathieu  
19.5 cm  
0422-19



Arruga  
16 cm  
0433-16



TC Arruga  
16 cm  
0438-16TC

Needle holders



Mathieu  
14 cm  
0430-14



Mathieu  
14 cm  
0431-14



Mathieu  
scissors combined  
14 cm  
0432-14



TC Mathieu  
14 cm  
0435-14TC



TC Mathieu  
14 cm  
0436-14TC



TC Micro-Barraquer  
with curved jaws  
18 cm  
0451-18TC



Mathieu  
17 cm  
0430-17



Mathieu  
17 cm  
0431-17



TC Mathieu  
14 cm  
0432-14TC



TC Mathieu  
17 cm  
0435-17TC



TC Mathieu  
17 cm  
0436-17TC



TC Micro-Barraquer  
18 cm  
0450-18TC

Needle holders



TC Castroviejo  
with curved jaws  
15.5 cm  
PR0460-15TC



Castroviejo  
14 cm  
0440-14



Castroviejo  
with curved jaws  
14 cm  
0441-14



Castroviejo  
14 cm / 60°  
0443-14



TC Castroviejo  
14 cm  
0445-14TC



TC Castroviejo  
14 cm  
0446-14TC



TC Castroviejo  
14 cm / 60°  
0448-14TC

Needle holders



Castroviejo  
13 cm  
0442-13



Castroviejo  
smooth jaws  
13 cm  
0442-13L



Castroviejo-Barraquer  
smooth jaws  
12 cm  
0444-12L



TC Castroviejo  
13 cm  
0447-13TC



Castroviejo  
18 cm  
0440-18



Castroviejo  
with curved jaws  
18 cm  
0441-18



TC Castroviejo  
18 cm  
0445-18TC



TC Castroviejo  
18 cm  
0446-18TC

Hemostats



1 Crile  
straight  
14 cm  
0520-1



2 Crile  
curved  
14 cm  
0520-2



1 Kocher 1x2  
straight  
14 cm  
0530-1

Hemostats



1 Halstead-Mosquito  
straight  
12 cm  
0500-1



1 Halstead-Mosquito  
straight  
12 cm  
W0502-1



2 Halstead-Mosquito  
curved  
12 cm  
0500-2



2 Kocher 1x2  
curved  
14 cm  
0530-2



1 Pean  
straight  
14 cm  
0540-1



2 Pean  
curved  
14 cm  
0540-2



2 Halstead-Mosquito  
curved  
12 cm  
W0502-2



1 Halstead-Mosquito 1x2  
straight  
12 cm  
0505-1



2 Halstead-Mosquito 1x2  
curved  
12 cm  
0505-2

Hemostats



1 Micro-Mosquito  
straight  
10 cm  
0501-1



2 Micro-Mosquito  
curved  
10 cm  
0501-2



1 Micro-Mosquito 1x2  
straight  
10 cm  
0506-1



2 Micro-Mosquito 1x2  
curved  
10 cm  
0506-2

Hemostats



1 Kelly  
straight  
14 cm  
0510-1



2 Kelly  
curved  
14 cm  
0510-2



1 Hartmann  
straight  
10 cm  
0515-1



2 Hartmann  
curved  
10 cm  
0515-2



**Orientable blade scalpel handle**

**Scalpel blade remover**

**Disposable scalpels \***

100 pcs / box



**0371-10**  
Sharp and thin, the blade of our disposable scalpels maintain its characteristic throughout the surgery intervention whether it is used superficially or at the periosteal tissue plane.



16 cm  
0335-1

16.5 cm  
0352



**S0352**  
kit of 0352 scalpel blade remover +  
0335-1 orientable blade scalpel handle



0371-10

0371-11

0371-12

0371-15

Scalpel handles



Scalpel handles



Scalpel blades \*  
100 pcs (sterile) / box



Micro-blades \*  
25 pcs (sterile) / box



Scalpel blades \*  
100 pcs (sterile) / box

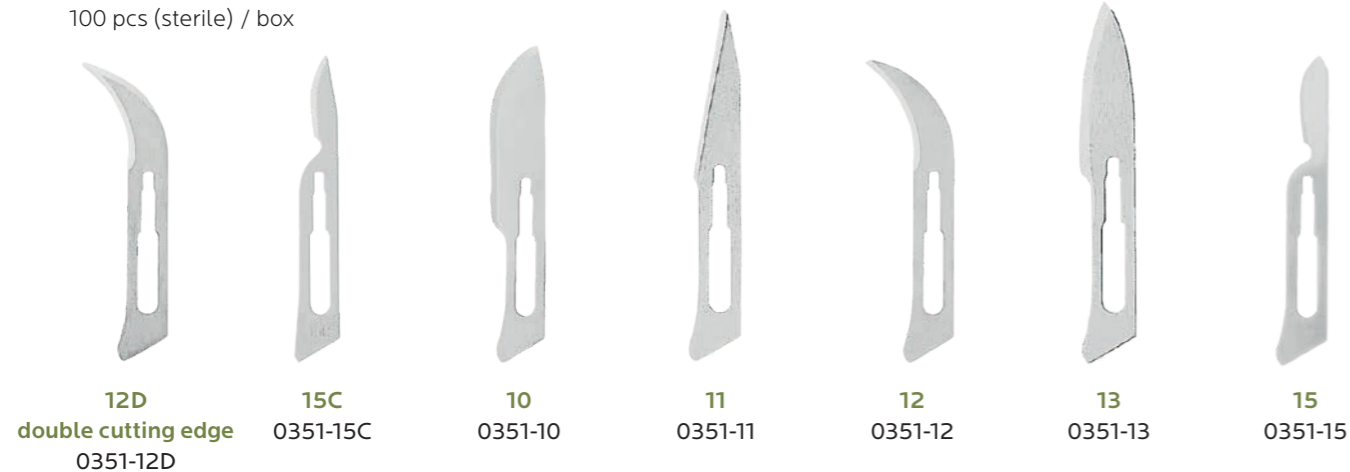

**Syringes**

non self-aspirating



1.8 ml cartridge  
metric thread  
0483-2



1.8 ml cartridge  
metric thread  
0483-3



2.2 ml cartridge  
imperial thread (Withworth)  
0482-3W



2.2 ml cartridge  
imperial thread (Withworth)  
0482-4W

**Syringes**

cork screw tip



1.8 ml cartridge  
metric thread  
0480-1



1.8 ml cartridge  
metric thread  
0480-2



1.8 ml cartridge  
metric thread  
0480-4

self-aspirating



1.8 ml cartridge  
metric thread  
0480-5



1.8 ml cartridge  
metric thread  
0480-6



1.8 ml cartridge  
metric thread  
0483-1



2.2 ml cartridge  
imperial thread (Withworth)  
0482-6W



1.8 ml cartridge  
imperial thread (Withworth)  
0480-4W



1.8 ml cartridge  
metric thread  
0480-3

spare caps for  
0480-1  
0480-2  
0480-3  
0480-4



metric thread  
0480-P1



imperial thread (Withworth)  
0480-P2

**Syringes**

intra-ligamental syringes

stainless steel syringe



1.8 ml cartridge  
metric thread  
0481-8

brass syringes with stainless steel moving parts

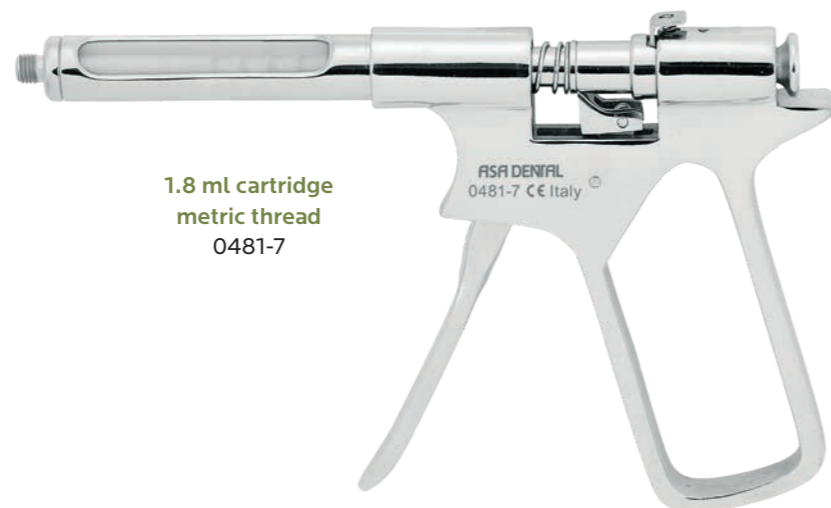

1.8 ml cartridge  
metric thread  
0481-7



2.2 ml cartridge  
imperial thread (Withworth)  
0482-7W

autoclavable plastic protection sleeve



0481-T1

syringe stand



0482-1

**Towel clamps**



1 Backhaus  
8 Cm  
0550-1



2 Backhaus  
11 Cm  
0550-2



3 Backhaus  
13 Cm  
0550-3



Schaedle  
9 Cm  
0680



Jones  
9 Cm  
0681



Dressing forceps



Gross-Maier  
straight  
20 cm  
0555-1



Gross-Maier  
straight  
25 cm  
0557-1



Gross-Maier  
curved  
20 cm  
0555-2



Gross-Maier  
curved  
25 cm  
0557-2

Mouth gags

for adults



Molt  
14 cm  
1870-2



Roser-Koenig  
19 cm  
1871-2

for children



Molt  
11 cm  
1870-1



Roser-Koenig  
16 cm  
1871-1

Tongue forceps



Collin  
16 cm  
0560



Young  
17 cm  
0561

0561-R

**Retractors - Tongue depressors**

lip retractors

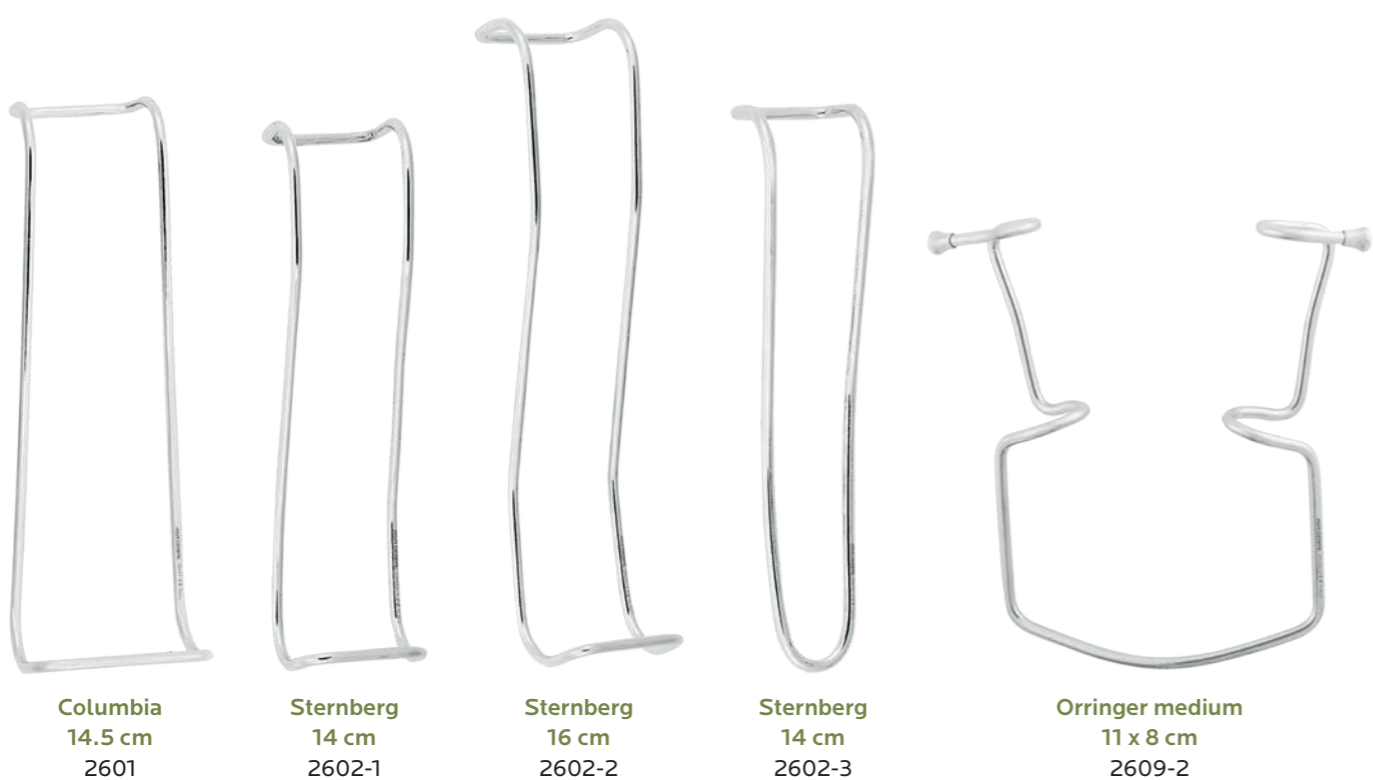

**Columbia**  
14.5 cm  
2601

**Sternberg**  
14 cm  
2602-1

**Sternberg**  
16 cm  
2602-2

**Sternberg**  
14 cm  
2602-3

**Orringer medium**  
11 x 8 cm  
2609-2

tongue depressor



14.5 cm  
2605

14.5 cm  
2606

**Buchwald**  
17 cm  
2607

**Brünings**  
19 cm  
2608

cheek retractor



**University of Minnesota**  
14 cm  
2604

**Retractors**



**blunt**  
16 cm  
2611-2

**Senn-Miller**  
**blunt**  
16 cm  
2613-2

**blunt**  
16 cm  
2611-1

**Senn-Miller**  
**sharp**  
16 cm  
2613-1

**Kilner**  
15 cm  
2615-1

**Farabeuf**  
13 cm  
2616-1



**Williger**  
**straight**  
**sharp**  
13 cm  
2617-1

**Williger**  
**left**  
**sharp**  
13 cm  
2617-2

**Williger**  
**right**  
**sharp**  
13 cm  
2617-3

**Williger**  
**right**  
**sharp**  
13 cm  
2617-33

**Williger**  
**left**  
**blunt**  
13 cm  
2618-2

**Retractors**

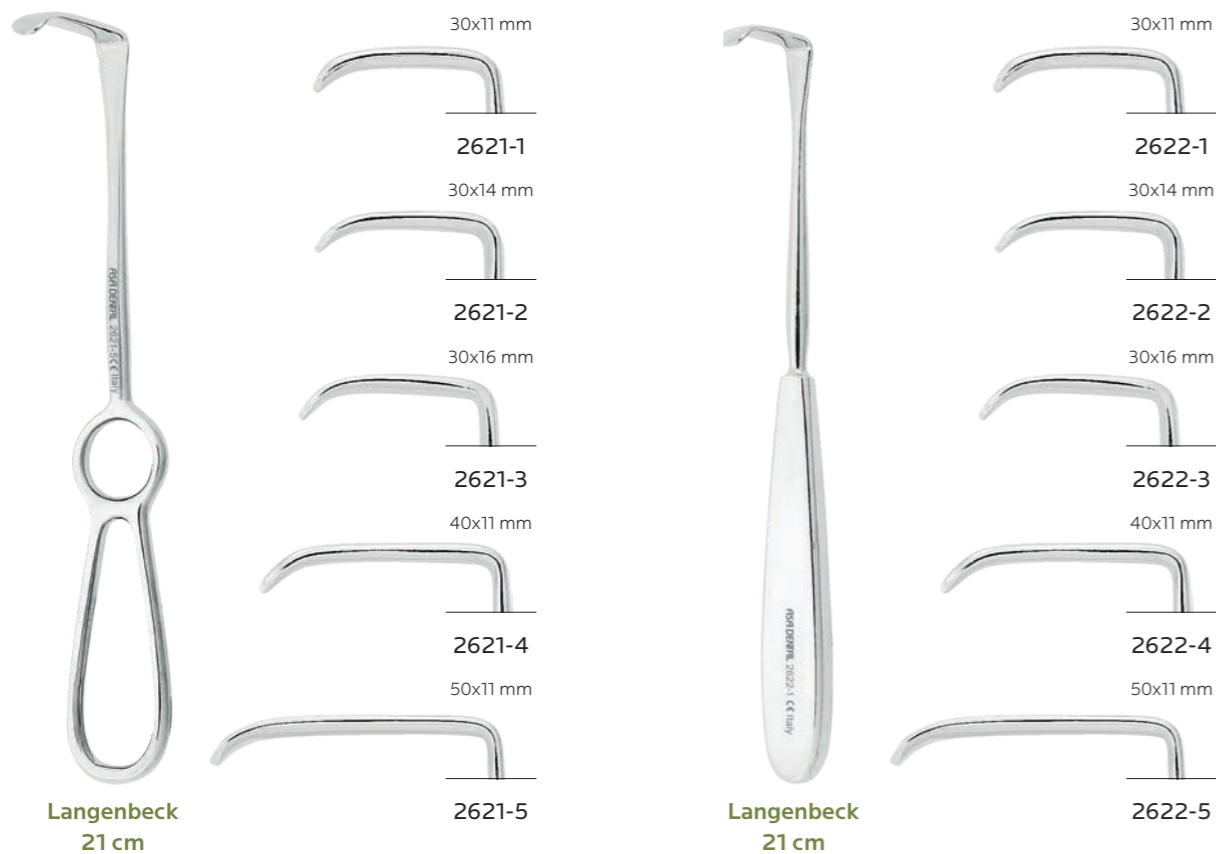

**Retractors**



labial retractor



**Antrum probes**

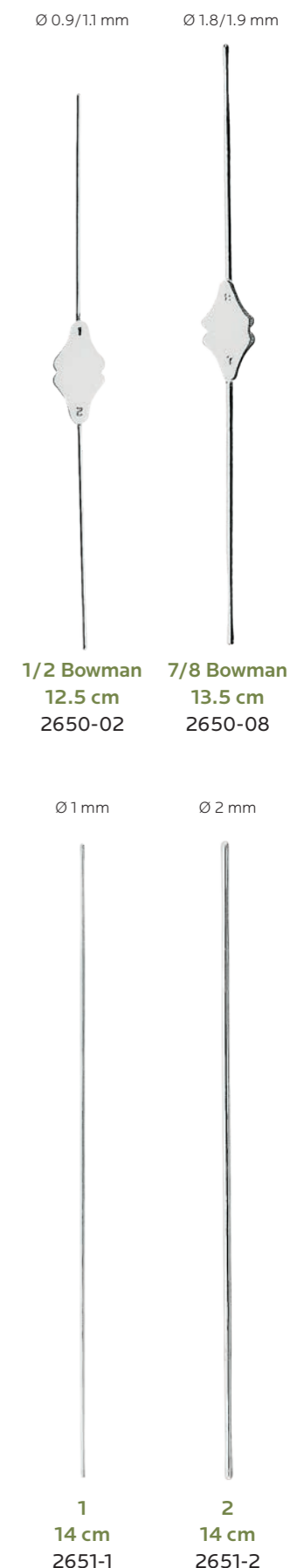

Tissue pliers



PR0632-1  
 ATRAUMATIC TISSUE PLIERS WITH THIN TIPS  
 allow maximum ease of handling in mobilizing  
 the soft tissue and in suturing.

0.8mm



Cooley  
 17.5 cm  
 PR0632-1



1  
 Adson  
 12 cm  
 0620-1



1  
 Adson 1x2  
 12 cm  
 0621-1



1  
 Micro-Adson 1x2  
 12 cm  
 0622-1

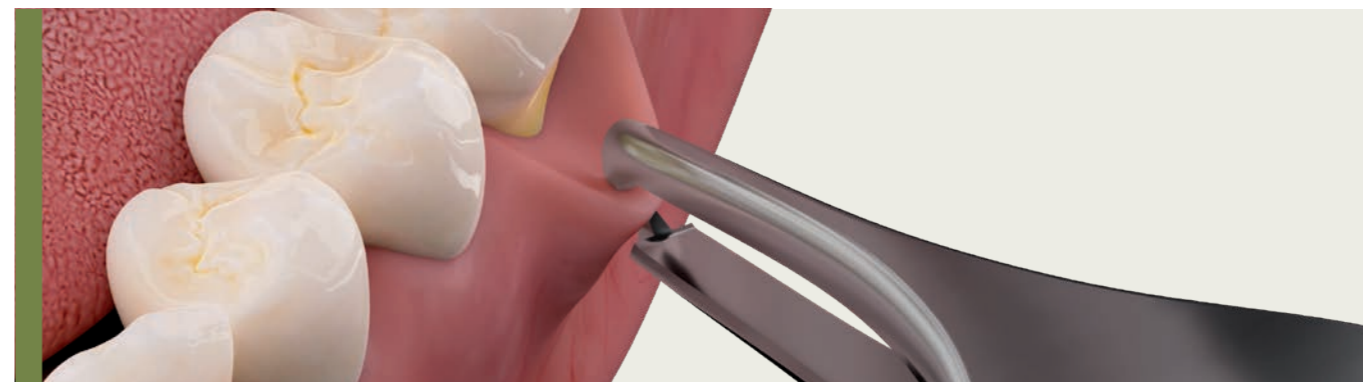

0622-2



2  
 Micro-Adson 1x2  
 15 cm  
 0622-2



10 cm  
 0623-1



Micro-Adson  
 12 cm  
 0624-1



Micro-Adson  
 15 cm  
 0624-2

Tissue pliers

suture pliers

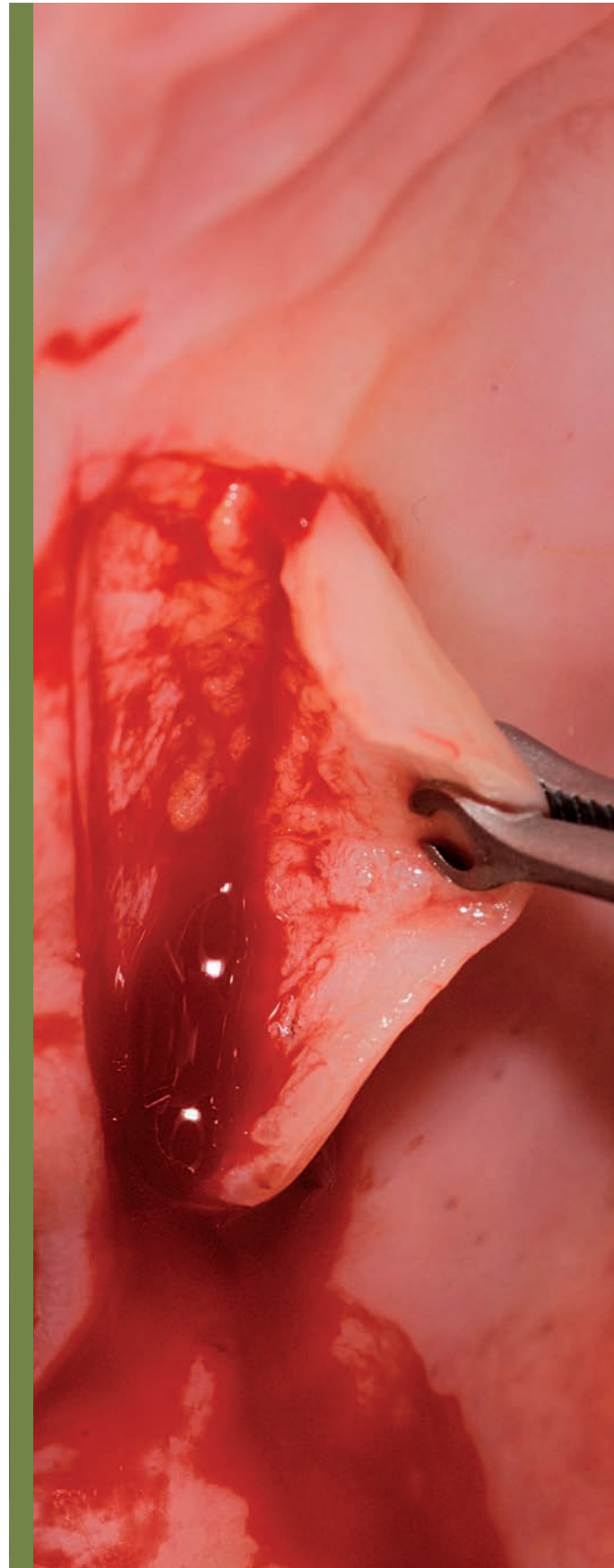

PR0625-3  
Allows atraumatic manipulation  
of the soft tissue and facilitate suturing



16 cm  
PR0625-2



17 cm  
PR0625-3



1  
15 cm  
0625-1



Adson Brown  
non traumatic  
12 cm  
0626-1



1  
Semken-Taylor  
12.5 cm  
0630-1



2  
Semken-Taylor  
12.5 cm  
0630-2



1  
Semken-Taylor 1x2  
12.5 cm  
0631-1



2  
Semken-Taylor 1x2  
12.5 cm  
0631-2

Tissue pliers

set of 5



1 · 2 · 3 · 4 · 5  
S0645

very thin tips



1  
12.5 cm  
0645-1



2  
12 cm  
0645-2



3  
11.5 cm  
0645-3



4  
11.5 cm  
0645-4



5  
11.5 cm  
0645-5



1  
13 cm  
0635-1



2  
14 cm  
0635-2



3  
15 cm  
0635-3



4  
18 cm  
0635-4



5  
20.5 cm  
0635-5

Tissue pliers

Surgical stainless steel saliva ejectors



Surgical aspirator tips

aspirator tips specially shaped for surgical use, autoclavable



Bone curettes



**1 Hemingway**  
2000-1  
Asa60  
MV 2000-1  
Asa Light MV  
ML2000-1  
Leonardo ML  
MC2000-1  
● Magic Color MC

**2 Hemingway**  
2000-2  
Asa60  
MV 2000-2  
Asa Light MV  
ML2000-2  
Leonardo ML  
MC2000-2  
● Magic Color MC

**3 Hemingway**  
2000-3  
Asa60  
MV 2000-3  
Asa Light MV  
ML2000-3  
Leonardo ML  
MC2000-3  
● Magic Color MC

**3**  
2014-3

Instruments kit for oral surgery



S3002-13

2	cotton and dressing pliers	0602-2
3	tissue pliers	0635-3
1	suture pliers	0625-1
	retractor	2611-2
	Mathieu needle holder	0430-14
	Castroviejo needle holder	0441-14
	scalpel handle	0350-3
	straight Spencer surgical scissors	0320-2
2	curved Metzenbaum surgical scissors	0321-2
	mouth mirror handle	2102-IN
	Buchwald retractor	2607
4	mouth mirror	2200-4
	tray	S2722-1

Instruments kit for oral surgery

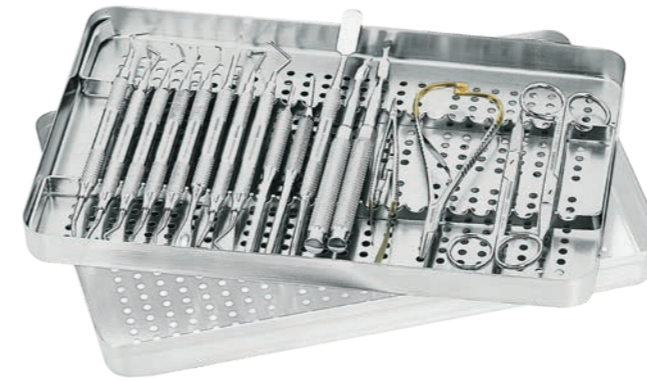

S3002-18

7/8	Gracey curette	MV1807-08
11/12	Gracey curette	MV1807-12
13/14	Gracey curette	MV1807-14
1	straight Goldman-Fox scissors	0304-1
2	curved Goldman-Fox scissors	0304-2
85	Lucas bone curette	MV2001-85
86	Lucas bone curette	MV2001-86
1/2	Kirkland knives	MV1803-D
1/2	Orban knives	MV1804-D
M9	Molt periosteal elevator	MV1850-M9
PR3	Prichard periosteal elevator	MV1851-PR3
5	straight scalpel handle	0350-5
5A	curved scalpel handle	0350-5A
1	Ochsenbein chisel	1800-1
2	Ochsenbein chisel	1800-2
	Castroviejo needle holder	0445-14TC
	Mathieu needle holder	0435-14TC
	tray	S2722-2



S3002-17

	mouth mirror handle	2102-IN
23	explorer	0700-23
2	London-College cotton and dressing pliers	0601-2
1	Semken-Taylor tissue pliers	0631-1
7	Goldman-Fox knives	1815-7
1/2	Orban knives	1804-D
M9	Molt periosteal elevator	MV1850-M9
PR3	Prichard periosteal elevator	MV1851-PR3
	Farabeuf retractor	2616-1
	Sternberg retractor	2602-1
	Senn-Miller retractor	2613-2
	Crile-Wood needle holder	0415-15TC
	Mathieu needle holder	0430-14
2	Goldman-Fox scissors	0304-2
1	straight Halstead-Mosquito Hemostats	0500-1
2	curved Halstead-Mosquito Hemostats	0500-2
5	mouth mirror	2200-5
	tray	S2722-1



4  
D

# EXTRACTIVE SURGERY

MADE IN ITALY

## FIX IT NOW BUT THINK LONG TERM

Removing a tooth is always an extreme measure, most of the time supposed to solve a painful situation for the patient. Even the simplest extractions demand the most careful manoeuvres, aiming at preserving the bone as much as possible without compromising the possibility of future implants. Yet, both your experience and medical literature tell you that there are cases demanding for procedures that are far more complex. A molar broken off at the gum line, an included or semi-included wisdom tooth, a non-erupting molar: the extraction turns into a real surgery with the necessity to create an access through the gum and minimize the amount of sacrificed bone. Being minimally invasive and extremely precise requires you a broad range of superior performance instruments, including a large variety of tooth-dedicated levers to address any type of intervention. This is what you find here.

- D4 Extracting forceps
- D37 Extracting forceps for children
- D40 Extracting forceps for roots
- D42 Bone rongeurs
- D44 Nippers
- D45 Root elevators
- D63 Root-tip picks
- D65 Syndesmotomes
- D68 Periotomes
- D68 Exciser
- D69 Kits
- D71 Accessories



Extracting forceps - range of application

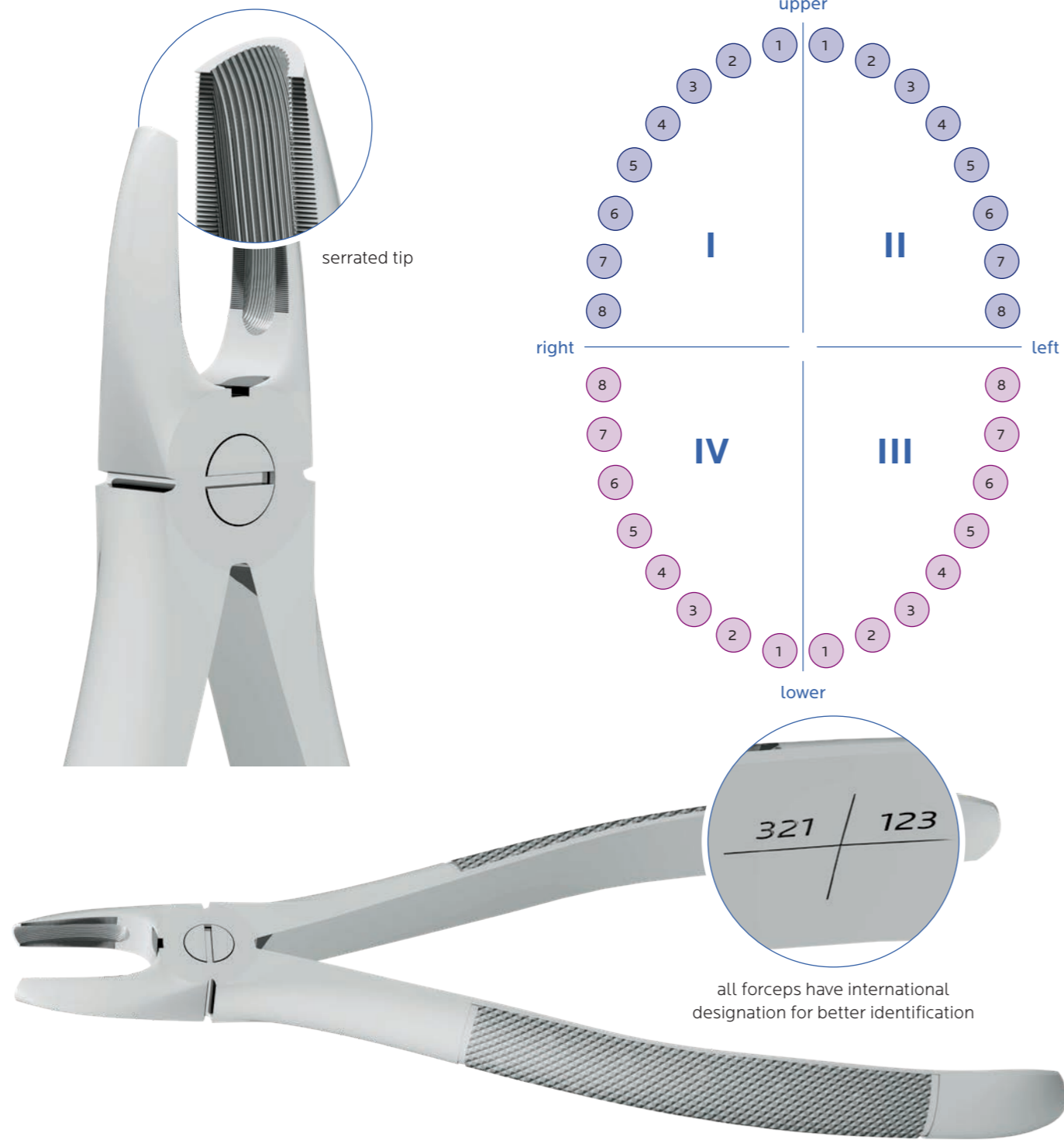

How to use

AsaLady

- products ergonomically designed for women hands:
- smaller and lighter handles
- smaller finger holes
- reduced size
- code starts with "W" or "SW"

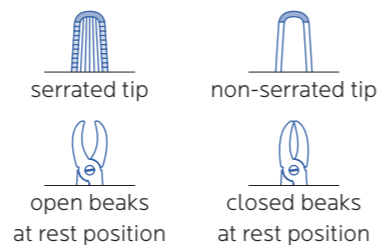
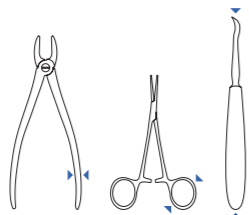

AsaLady	Code	incisors and canines		pre-molars		molars		roots		third molars		for children	
		lower	upper	lower	upper	lower	upper	lower	upper	lower	upper	lower	upper
0100-1	W0160-1		•										
0100-2	W0160-2		•										
0100-3			•										
0100-4	W0160-4	•											
0100-7	W0160-7			•	•								
0100-8				•									
0100-13	W0160-13			•									
0100-17	W0160-17					•	•						
0100-18	W0160-18					•	•						
0100-18A						•							
0100-19								•					
0100-20										•			
0100-21	W0160-21					•	•						
0100-22	W0160-22					•	•						
0100-22L						•	•			•			
0100-22R						•	•			•			
0100-23													
0100-24						•							
0100-29													
0100-29N			•					•	•				
0100-30													
0100-31			•										
0100-33	W0160-33							•	•				
0100-33A								•	•				
0100-33L								•	•				
0100-38A								•	•				
0100-41										•			
0100-43A										•			
0100-44										•			
0100-45	W0160-45							•	•				
0100-46								•	•				
0100-46L								•	•				
0100-48										•			
0100-49										•			
0100-51													
0100-51A	W0160-51A												
0100-51L													
0100-51LX													
0100-52			•										
0100-54													
0100-55													
0100-56						•							
0100-59								•	•				
0100-59L			•										
0100-60													
0100-65L													
0100-65R													
0100-66L													
0100-66R													
0100-67													
0100-67A	W0160-67A												
0100-67/L													
0100-67/R													
0100-68													
0100-73													
0100-74	W0160-74												
0100-74M			•										
0100-74N													
0100-75			•										
0100-79	W0160-79												
0100-79A													
0100-79C													
0100-86/L													
0100-86/R													
0100-86C	W0160-86C												
0100-86W													
0100-87													
0100-89													
0100-90													
0100-99													
0100-107													
0100-121			•										
0100-145	W0160-145												
0100-151/	W0160-151/												
0100-166													
0100-167													
0100-168													
0100-169													
0100-346													
0100-349													
0100-359													
0104-1													
0104-2													
0104-3													
0104-4													
0120-5	W0121-5												
0120-6	W0121-6												
0120-10S	W0121-10S												
0120-16	W0121-16												
0120-17	W0121-17												
0120-18L	W0121-18L												
0120-18R	W0121-18R												
0120-23	W0121-23												
0120-53R	W0121-53R												
0120-53L	W0121-53L												
0120-65	W0121-65												
0120-69	W0121-69												
0120-88R	W0121-88R												
0120-88L	W0121-88L												
0120-101	W0121-101												
0120-150	W0121-150												
0120-150S	W0121-150S												
0120-151	W0121-151												
0120-151S	W0121-151S												
0120-222	W0121-222												
0130-1													
0130-2													
0130-4													
0130-7													
0130-13													
0130-17													
0130-18													
0130-21													
0130-22													
0130-33													
0130-45													
0130-51A													
0130-67A													
0130-74													
0130-79													
0130-86C													
0130-89													
0130-90													
0130-145													
0130-151/													
0130-349													
0130-359													
0110-37													
0110-39													
0110-39R													
0110-39L													
0110-51S													
0110-13S													
0110-22S													
0110-30S													
0110-33S													
0110-38													
0112-1													
0112-2													
0112-3													
0112-4													
0112-5													
0112-6													
0112-7													
0101-1													
0101-2													
0102-1													
0102-2													

**Extracting forceps**

serrated tips



S0100-1

1	0100-1
17	0100-17
18	0100-18
79	0100-79
67A	0100-67A
51A	0100-51A
13	0100-13
22	0100-22



**1**  
17 cm  
0100-1  
upper incisors  
and canines

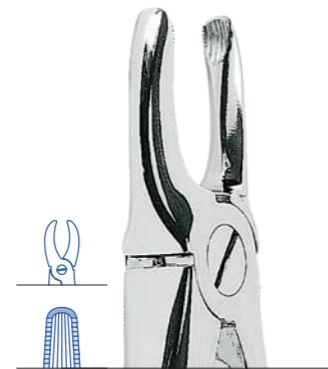

**3**  
17 cm  
0100-3  
overlapping upper  
incisors and canines



**7**  
17 cm  
0100-7  
upper incisors  
upper premolars

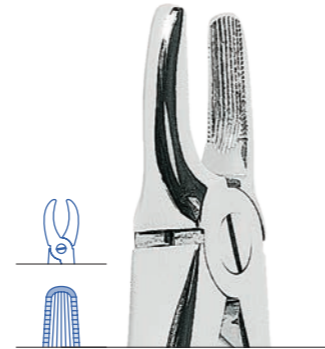

**2**  
18 cm  
0100-2  
upper incisors  
and canines

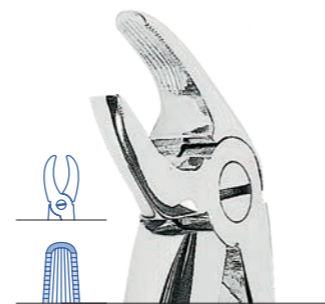

**4**  
14 cm  
0100-4  
lower incisors  
and canines

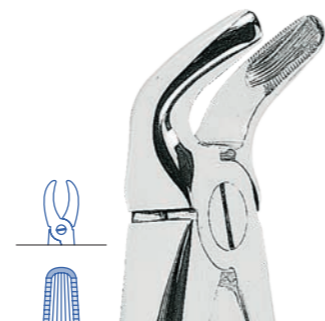

**8**  
16 cm  
0100-8  
lower premolars

**Extracting forceps**

serrated tips



S0100-2

1	0100-1
7	0100-7
17	0100-17
18	0100-18
4	0100-4
13	0100-13
22	0100-22
86C	0100-86C



**13**  
15 cm  
0100-13  
lower premolars



**18**  
17 cm  
0100-18  
upper molars  
left

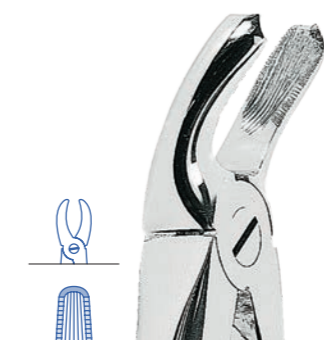

**20**  
14 cm  
0100-20  
lower third molars

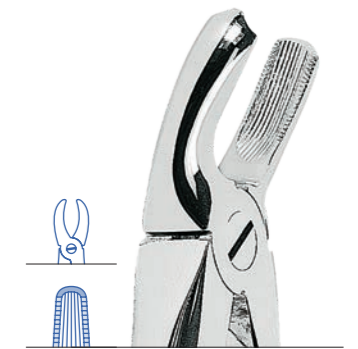

**17**  
17 cm  
0100-17  
upper molars  
right



**18A**  
17 cm  
0100-18A  
upper molars



**21**  
16 cm  
0100-21  
lower molars

**Extracting forceps**

serrated tips



**19**  
17 cm  
0100-19  
upper third molars



**22**  
15 cm  
0100-22  
lower molars



**22L Routurier**  
18 cm  
0100-22L  
lower molars and  
third molars, left



**22R Routurier**  
18 cm  
0100-22R  
lower molars and  
third molars, right



**23**  
0100-23  
15 cm  
lower molars  
right



**24**  
15 cm  
0100-24  
lower molars  
left

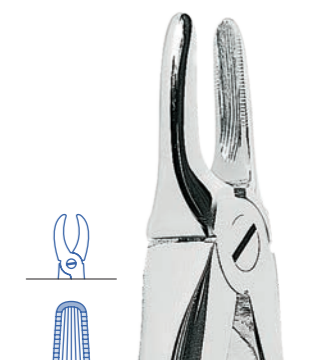

**29**  
17 cm  
0100-29  
upper roots

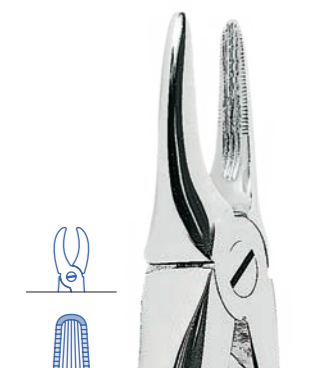

**29N**  
17 cm  
0100-29N  
upper roots  
and incisors

**Extracting forceps**

serrated tips

**Extracting forceps**

serrated tips



0100-45  
Curved extracting forceps for lower roots.



**30**  
17 cm  
0100-30  
upper roots

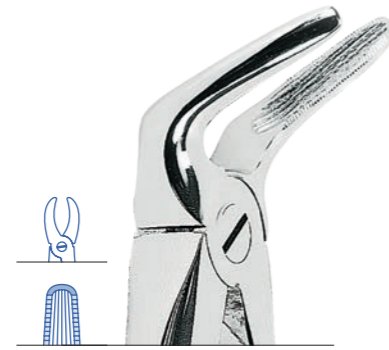

**31**  
16 cm  
0100-31  
lower roots  
and incisors



**33**  
15 cm  
0100-33  
lower roots



**33A**  
15 cm  
0100-33A  
lower roots



**33L**  
15 cm  
0100-33L  
lower roots



**38A**  
15 cm  
0100-38A  
fractured or decayed  
lower teeth



**41**  
19 cm  
0100-41  
upper roots



**43A**  
17 cm  
0100-43A  
fractured or decayed  
upper teeth



**44**  
19 cm  
0100-44  
upper roots

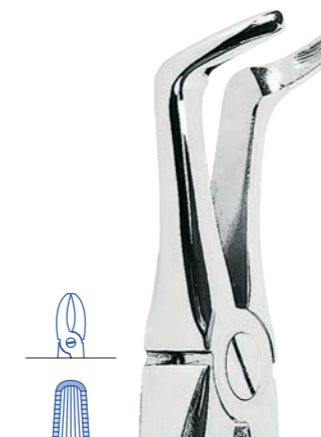

**46**  
18 cm  
0100-46  
lower roots



**45**  
18 cm  
0100-45  
lower roots



**46L**  
18 cm  
0100-46L  
lower roots

**Extracting forceps**

serrated tips



**48**  
19 cm  
0100-48  
upper roots



**49**  
19 cm  
0100-49  
upper roots

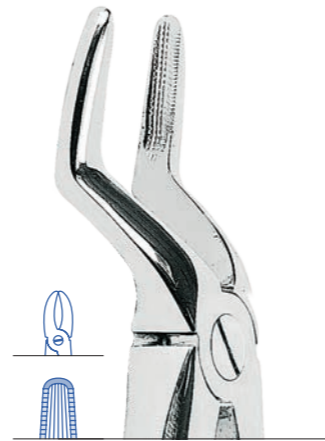

**51**  
18 cm  
0100-51  
upper roots



**51A**  
18 cm  
0100-51A  
upper roots



**51L**  
19 cm  
0100-51L  
upper roots

**Extracting forceps**

serrated tips



**51LX**  
20 cm  
0100-51LX  
upper roots



**52**  
18 cm  
0100-52  
upper roots  
and canines

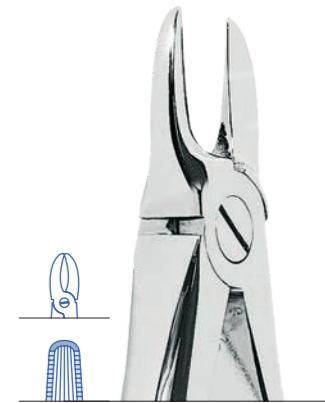

**54**  
17 cm  
0100-54  
for separating  
upper molars



**55**  
17 cm  
0100-55  
for separating  
upper molars



**56**  
16 cm  
0100-56  
for separating  
lower molars



**59**  
15 cm  
0100-59  
lower roots



**59L**  
16 cm  
0100-59L  
lower incisor roots

Extracting forceps

serrated tips

Extracting forceps

serrated tips



**60**  
15 cm  
0100-60  
lower roots



**65L**  
17 cm  
0100-65L  
upper molars  
left



**65R**  
17 cm  
0100-65R  
upper molars  
right



**66L**  
17 cm  
0100-66L  
upper molars  
left



**66R**  
17 cm  
0100-66R  
upper molars  
right



**67**  
18 cm  
0100-67  
upper third molars



**67A**  
19 cm  
0100-67A  
upper third molars



**67 1/2 L**  
18 cm  
0100-67/L  
upper third molars  
left



**67 1/2 R**  
18 cm  
0100-67/R  
lower incisor roots

Extracting forceps

serrated tips



**68**  
18 cm  
0100-68  
lower roots



**73**  
16 cm  
0100-73  
lower molars



**74**  
16 cm  
0100-74  
lower roots



**74M**  
15 cm  
0100-74M  
lower roots



**74N**  
16 cm  
0100-74N  
lower roots



**75**  
16 cm  
0100-75  
lower canines  
and premolars



**79**  
17 cm  
0100-79  
lower third molars



**79A**  
17 cm  
0100-79A  
lower third molars



**79C**  
17 cm  
0100-79C  
lower third molars

**Extracting forceps**

non-serrated tips

**Extracting forceps**

non-serrated tips



**86 1/2L Roururier**  
17 cm  
0100-86/L  
lower third molars  
left



**86 1/2R Roururier**  
17 cm  
0100-86/R  
lower third molars  
right



**86C**  
16 cm  
0100-86C  
lower molars



**86W White**  
17 cm  
0100-86W  
for lower last molar



**87**  
16 cm  
0100-87  
lower decayed molars  
or broken crowns



**166 Trotter**  
17 cm  
0100-166  
universal extracting forceps  
for upper teeth, in particular  
molars and premolars

Extracting forceps

serrated tips



**89**  
18 cm  
0100-89  
upper molars  
right



**90**  
18 cm  
0100-90  
upper molars  
left



**99**  
16 cm  
0100-99  
lower molars with  
broken crowns



**107**  
17 cm  
0100-107  
upper canines

Extracting forceps

serrated tips



**121 Ogden-Felsch**  
18 cm  
0100-121  
upper third molars



**145**  
18 cm  
0100-145  
lower roots



**151 1/2**  
19 cm  
0100-151/  
upper roots

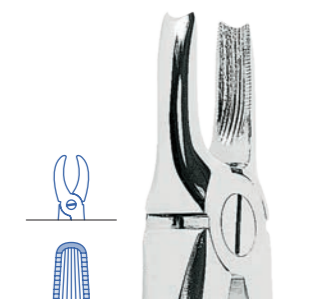

**168 Trotter**  
17 cm  
0100-168  
upper canines



**346**  
18 cm  
0100-346  
lower roots

Extracting forceps

non-serrated tips

serrated tips

serrated tips

Extracting forceps - AsaLady

serrated tips



**167 Trotter**  
16 cm  
0100-167  
universal extracting forceps  
for lower teeth, in particular  
molars and premolars



**169 Trotter**  
16 cm  
0100-169  
upper third molars



**359**  
16 cm  
0100-359  
lower roots



**349**  
19 cm  
0100-349  
upper roots



**1**  
15 cm  
W0160-1  
upper incisors  
and canines



**2**  
16 cm  
W0160-2  
upper incisors  
and canines



**7**  
15 cm  
W0160-7  
upper incisors  
upper premolars



**17**  
15 cm  
W0160-17  
upper molars  
right



**4**  
14 cm  
W0160-4  
lower incisors  
and canines

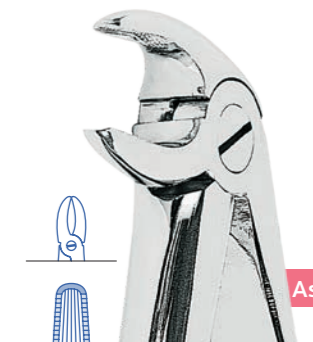

**13**  
13 cm  
W0160-13  
lower premolars



**18**  
15 cm  
W0160-18  
upper molars  
left

Extracting forceps - AsaLady

serrated tips

Extracting forceps - AsaLady

serrated tips

non-serrated tips



**22**  
13 cm  
W0160-22  
lower molars



**33**  
13 cm  
W0160-33  
lower roots



**W0160-51A**  
Angled extracting forceps for upper roots.



**21**  
14 cm  
W0160-21  
lower molars



**45**  
16 cm  
W0160-45  
lower roots



**51A**  
17 cm  
W0160-51A  
upper roots



**79**  
15 cm  
W0160-79  
lower third molars



**145**  
16 cm  
W0160-145  
lower roots



**86C**  
14 cm  
W0160-86C  
lower molars



**67A**  
17 cm  
W0160-67A  
upper third molars



**74**  
14 cm  
W0160-74  
lower roots



**151 1/2**  
18 cm  
W0160-151/  
upper roots

**Extracting forceps - MEAD pattern**

serrated tips



**1**  
17 cm  
0104-1  
universal extracting  
forcep for upper  
incisors and canines



**2**  
17 cm  
0104-2  
upper molars

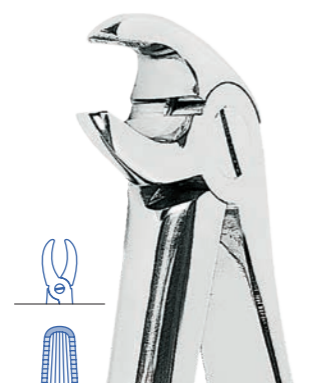

**3**  
15 cm  
0104-3  
lower incisors,  
premolars and roots



**4**  
15 cm  
0104-4  
lower molars



0104-1

**Extracting forceps - AMERICAN pattern**

non-serrated tips



**5 Physick**  
18 cm  
0120-5  
lower third molars



**6**  
17 cm  
0120-6  
separating forceps



**10S**  
18 cm  
0120-10S  
upper molars



**16**  
17 cm  
0120-16  
lower molars



**17**  
18 cm  
0120-17  
lower molars

**Extracting forceps - AMERICAN pattern**

non-serrated tips

**Extracting forceps - AMERICAN pattern**

non-serrated tips



**18L Harris**  
18 cm  
0120-18L  
upper molars  
left



**18R Harris**  
18 cm  
0120-18R  
upper molars  
right



**23**  
18 cm  
0120-23  
lower molars



**53R**  
19 cm  
0120-53R  
upper molars  
right



**53L**  
19 cm  
0120-53L  
upper molars  
left



**65**  
19 cm  
0120-65  
upper incisors  
and roots



**69 Tomes**  
18 cm  
0120-69  
upper and  
lower roots



**88L Nevius**  
18 cm  
0120-88L  
upper molars  
left



**88R Nevius**  
18 cm  
0120-88R  
upper molars  
right



**101 Hull**  
16 cm  
0120-101  
deciduous teeth

**Extracting forceps - AMERICAN pattern**

non-serrated tips



**150 Cryer**  
18 cm  
0120-150  
upper incisors,  
premolars, roots



**150S Cryer**  
16 cm  
0120-150S  
upper teeth  
(for children)



**151 Cryer**  
17 cm  
0120-151  
lower incisors,  
premolars, roots



**151S Cryer**  
15 cm  
0120-151S  
lower teeth  
(for children)



**222**  
18 cm  
0120-222  
lower third molars

**Extracting forceps - AMERICAN pattern, AsaLady**

non-serrated tips



**5 Physick**  
16 cm  
W0121-5  
lower third molars



**6**  
16 cm  
W0121-6  
separating forceps



**10S**  
17 cm  
W0121-10S  
upper molars

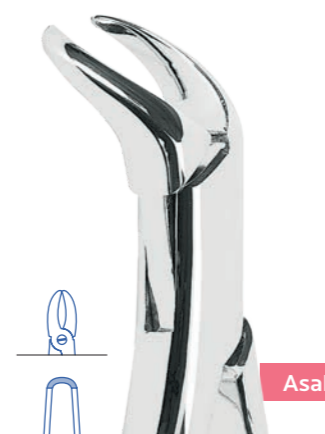

**16**  
16 cm  
W0121-16  
lower molars



**17**  
16 cm  
W0121-17  
lower molars

W0121-5

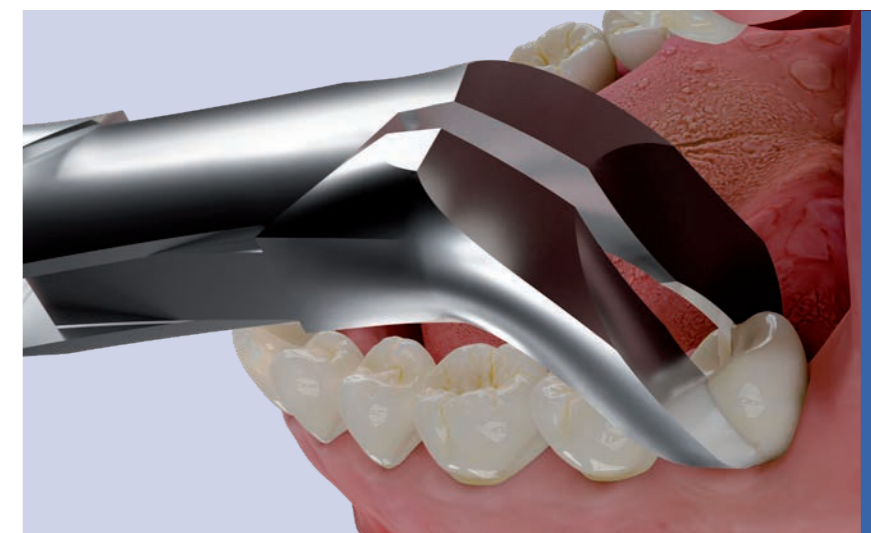

Extracting forceps - AMERICAN pattern, AsaLady

non-serrated tips

Extracting forceps - AMERICAN pattern, AsaLady

non-serrated tips



**18L Harris**  
16 cm  
W0121-18L  
upper molars  
left

AsaLady



**18R Harris**  
16 cm  
W0121-18R  
upper molars  
right

AsaLady



**23**  
16 cm  
W0121-23  
lower molars

AsaLady



**53R**  
17 cm  
W0121-53R  
upper molars  
right

AsaLady



**53L**  
17 cm  
W0121-53L  
upper molars  
left

AsaLady



**65**  
18 cm  
W0121-65  
upper incisors  
and roots

AsaLady



**69 Tomes**  
18 cm  
W0121-69  
upper and  
lower roots

AsaLady



**88L Nevius**  
17 cm  
W0121-88L  
upper molars  
left

AsaLady



**88R Nevius**  
17 cm  
W0121-88R  
upper molars  
right

AsaLady



**101 Hull**  
W0121-101  
deciduous teeth

AsaLady

**Extracting forceps - AMERICAN pattern, AsaLady**

non-serrated tips

**Extracting forceps - ANATOMICALLY SHAPED handle**

serrated tips



AsaLady

**150 Cryer**  
17 cm  
W0121-150  
upper incisors,  
premolars, roots



AsaLady

**150S Cryer**  
W0121-150S  
upper teeth  
(for children)



AsaLady

**151 Cryer**  
16 cm  
W0121-151  
lower incisors,  
premolars, roots



AsaLady

**151S Cryer**  
W0121-151S  
lower teeth  
(for children)

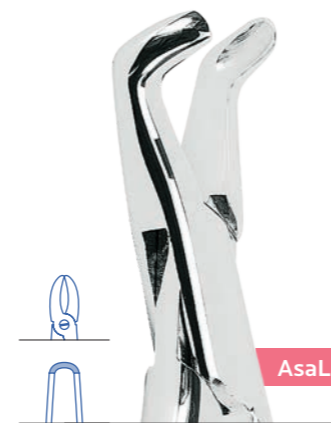

AsaLady

**222**  
17 cm  
W0121-222  
lower third molars



**1**  
17 cm  
0130-1  
upper incisors  
and canines

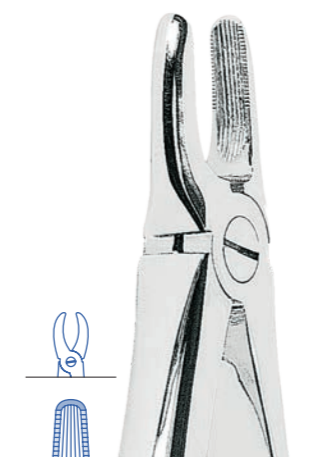

**2**  
17 cm  
0130-2  
upper incisors  
and canines



**4**  
16 cm  
0130-4  
lower incisors  
and canines

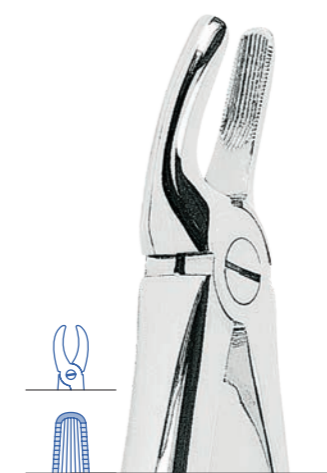

**7**  
16 cm  
0130-7  
upper premolars



**13**  
15 cm  
0130-13  
lower premolars

**Extracting forceps - ANATOMICALLY SHAPED handle**

serrated tips

**Extracting forceps - ANATOMICALLY SHAPED handle**

serrated tips



**17**  
17 cm  
0130-17  
upper molars  
right



**18**  
17 cm  
0130-18  
upper molars  
left



**21**  
17 cm  
0130-21  
lower molars

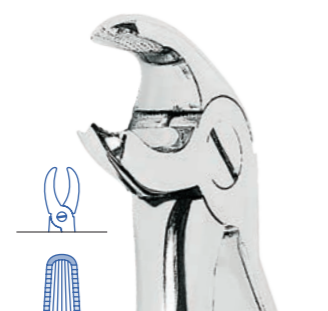

**22**  
15 cm  
0130-22  
lower molars

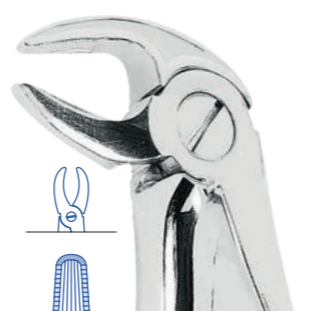

**33**  
15 cm  
0130-33  
lower roots

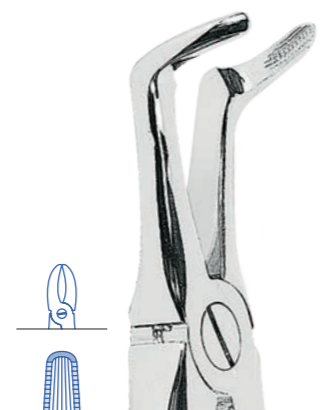

**45**  
18 cm  
0130-45  
lower roots



**51A**  
18 cm  
0130-51A  
upper roots



**67A**  
18 cm  
0130-67A  
upper third molars



**74**  
16 cm  
0130-74  
lower roots



**79**  
17 cm  
0130-79  
lower third molars



**86C**  
15 cm  
0130-86C  
lower molars

**Extracting forceps - ANATOMICALLY SHAPED handle**

serrated tips



**89**  
17 cm  
0130-89  
upper molars  
right



**90**  
17 cm  
0130-90  
upper molars  
left



**145**  
18 cm  
0130-145  
lower roots



**151 1/2**  
19 cm  
0130-151/  
upper roots



**349**  
18 cm  
0130-349  
upper roots



**359**  
16 cm  
0130-359  
lower roots

**Extracting forceps for children**

serrated tips



**13S**  
13 cm  
0110-13S  
lower premolars



**22S**  
14 cm  
0110-22S  
lower molars



**30S**  
15 cm  
0110-30S  
upper incisors  
and roots

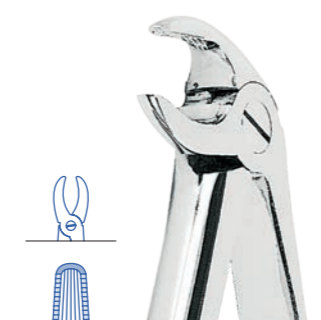

**33S**  
14 cm  
0110-33S  
lower roots

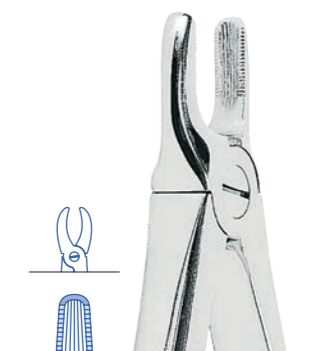

**37**  
15 cm  
0110-37  
upper incisors,  
premolars, roots

**Extracting forceps for children**

serrated tips



S0110

37	0110-37
39	0110-39
39R	0110-39R
39L	0110-39L
51S	0110-51S
13S	0110-13S
30S	0110-30S
33S	0110-33S
22S	0110-22S
38	0110-38



**38**  
14 cm  
0110-38  
lower incisors  
and canines



**39**  
15 cm  
0110-39  
upper molars

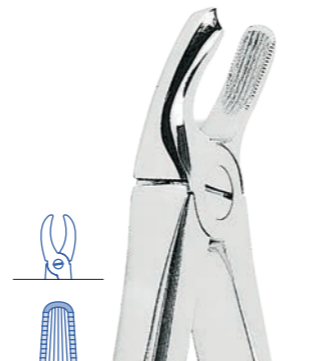

**39R**  
15 cm  
0110-39R  
upper molars  
right

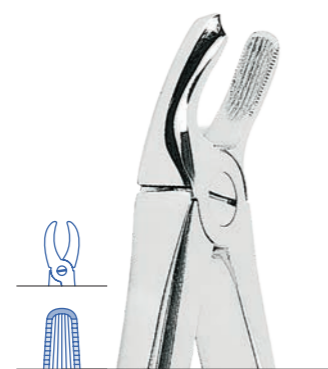

**39L**  
15 cm  
0110-39L  
upper molars  
left



**51S**  
16 cm  
0110-51S  
upper roots

**Extracting forceps for children - KLEIN pattern**

serrated tips



S0112

1	0112-1	5	0112-5
2	0112-2	6	0112-6
3	0112-3	7	0112-7
4	0112-4		



**2**  
13 cm  
0112-2  
upper premolars

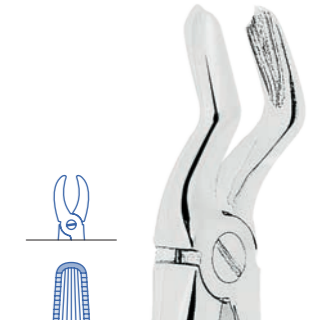

**3**  
13 cm  
0112-3  
upper molars



**1**  
12 cm  
0112-1  
upper incisors



**4**  
13 cm  
0112-4  
upper roots



**5**  
11 cm  
0112-5  
lower incisors

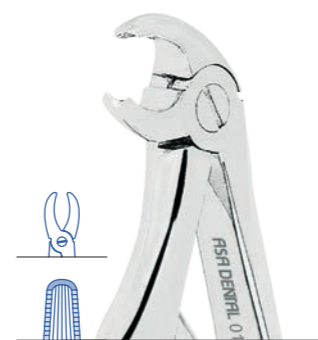

**6**  
11 cm  
0112-6  
lower molars



**7**  
11 cm  
0112-7  
lower roots

**Extracting forceps for roots**

serrated tips



**0101-1**  
Witzel extracting forceps are pliers handle versatile instruments that can be used for extraction of both teeth and roots. The serrated tips, the curved jaw and the slim profile make them effective on roots, preventing unwanted fractures.

**Extracting forceps for root splinters**

non-serrated tips



**0102-1**  
This forceps are designed for precision and sensitivity. The scissor-like handle increases guidance while the narrow beak allows reaching and firmly holding small root fragments.



**1 Witzel**  
15 cm  
0101-1  
lower roots



**2 Witzel**  
15 cm  
0101-2  
upper roots



**1 Stieglitz**  
14 cm  
0102-1  
root fragments



**2 Stieglitz**  
13 cm  
0102-2  
root fragments

Bone rongeurs

Bone rongeurs



Luer  
15 cm  
0103-10



Friedman  
14 cm  
0103-20



Mini Friedman  
12 cm  
0103-25



Cleveland 5  
16 cm  
0103-40



Cleveland-Gardner  
16 cm  
0103-45



Blumenthal  
15 cm  
0103-30



Blumenthal  
14 cm  
0103-31



Blumenthal  
14 cm  
0103-32



Mead 1A  
16 cm  
0103-50

**Bone rongeurs**

multiple action

**Bone/soft tissue nipper**

small size for use  
in limited access areas

**Root elevators with stainless steel handle**



0234-1



**Mini-Ruskin**  
15 cm  
0103-70



**Beyer**  
17 cm  
0103-71



**Goldman-Fox**  
10 cm  
0103-60



**1 Hylin**  
0234-1



**2 Hylin**  
0234-2



**3 Hylin**  
0234-3



**4 Hylin**  
0234-4

Root elevators with stainless steel handle



0231-2



Root elevators with stainless steel handle



1B	0200-1
4B	0200-4
2F	0201-2
3F	0201-3
44	0220-44
45	0220-45

S0200-6



Root elevators with stainless steel handle



Root elevators with stainless steel handle



S0200-10

2B	0200-2
3B	0200-3
4B	0200-4
2F	0201-2
3F	0201-3
1	0291-1
2	0291-2
3	0291-3
320	0202-320
321	0202-321



Root elevators with stainless steel handle

helicoidal tips



S0244-6

1K	0244-1
2K	0244-2
3K	0244-3
4K	0244-4
5K	0244-5
6K	0244-6

Root elevators with stainless steel handle

helicoidal tips



Root elevators with stainless steel handle



Root elevators with stainless steel handle



Root elevators with stainless steel handle

Root elevators with stainless steel handle



Root elevators with stainless steel handle



Root elevators with stainless steel handle

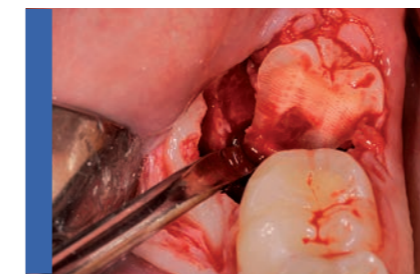

0229-1F  
Almost all impacted lower third molars can be handled with this Friedman elevator that, applied from above in the gap produced by bone resection, dislocates the tooth upward and backward. Third molar cut and removal of fragment with the Friedman elevator (double mirror + Friedman)

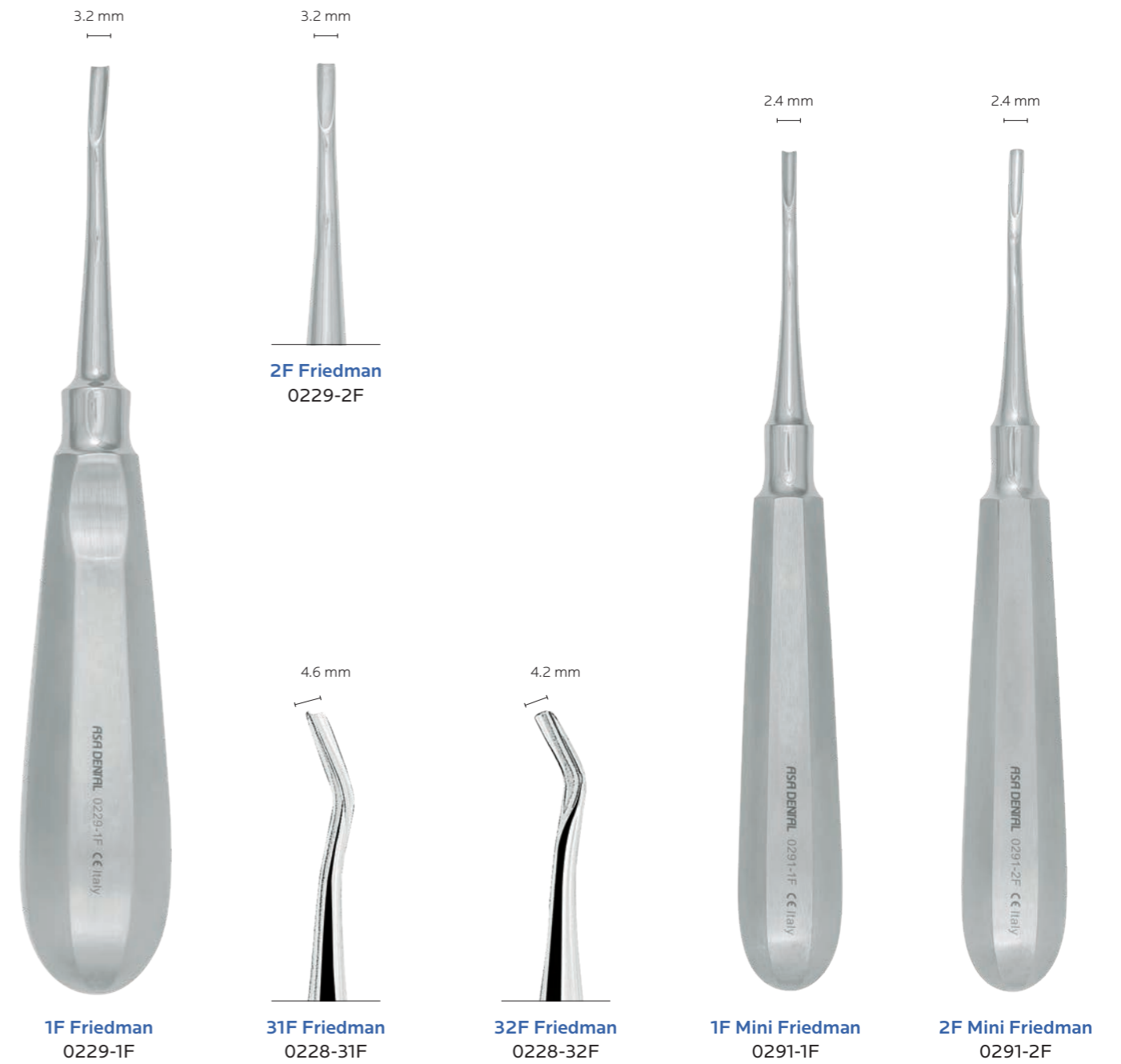

Root elevators with stainless steel handle

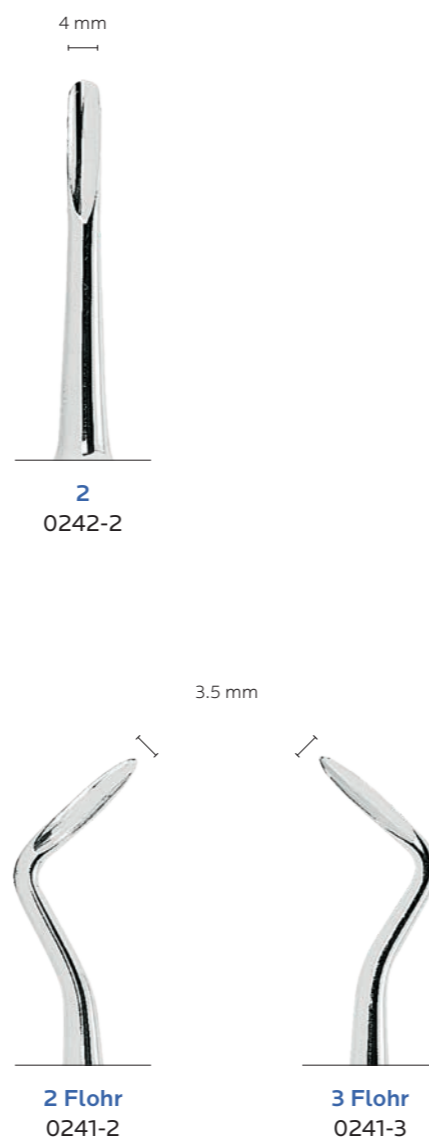

Root elevators with stainless steel ANATOMICALLY SHAPED handle

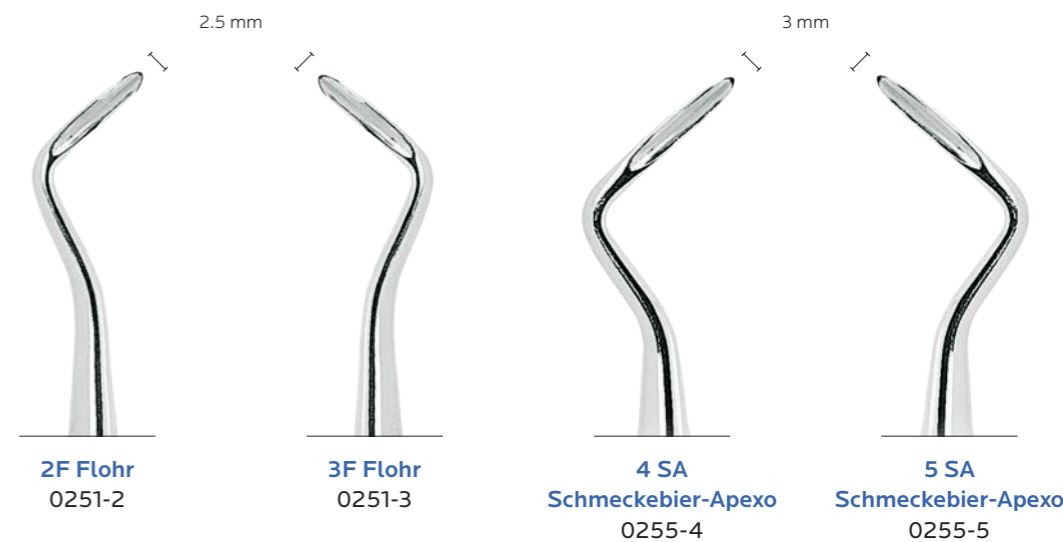
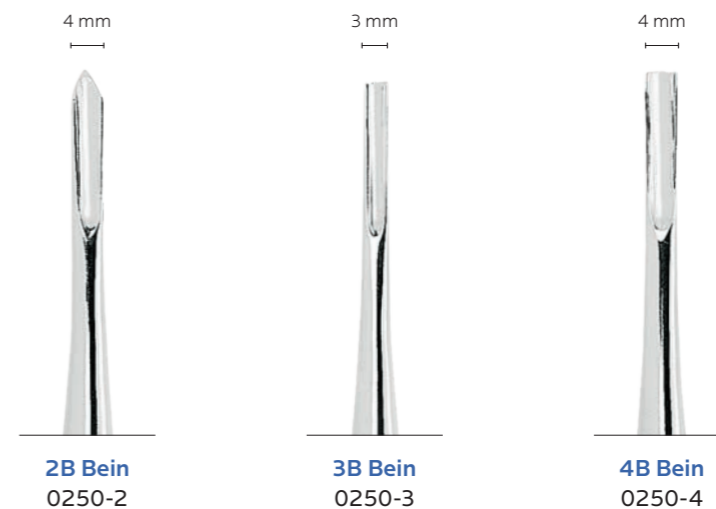

Root elevators with stainless steel ANATOMICALLY SHAPED handle



Root elevators with stainless steel handle

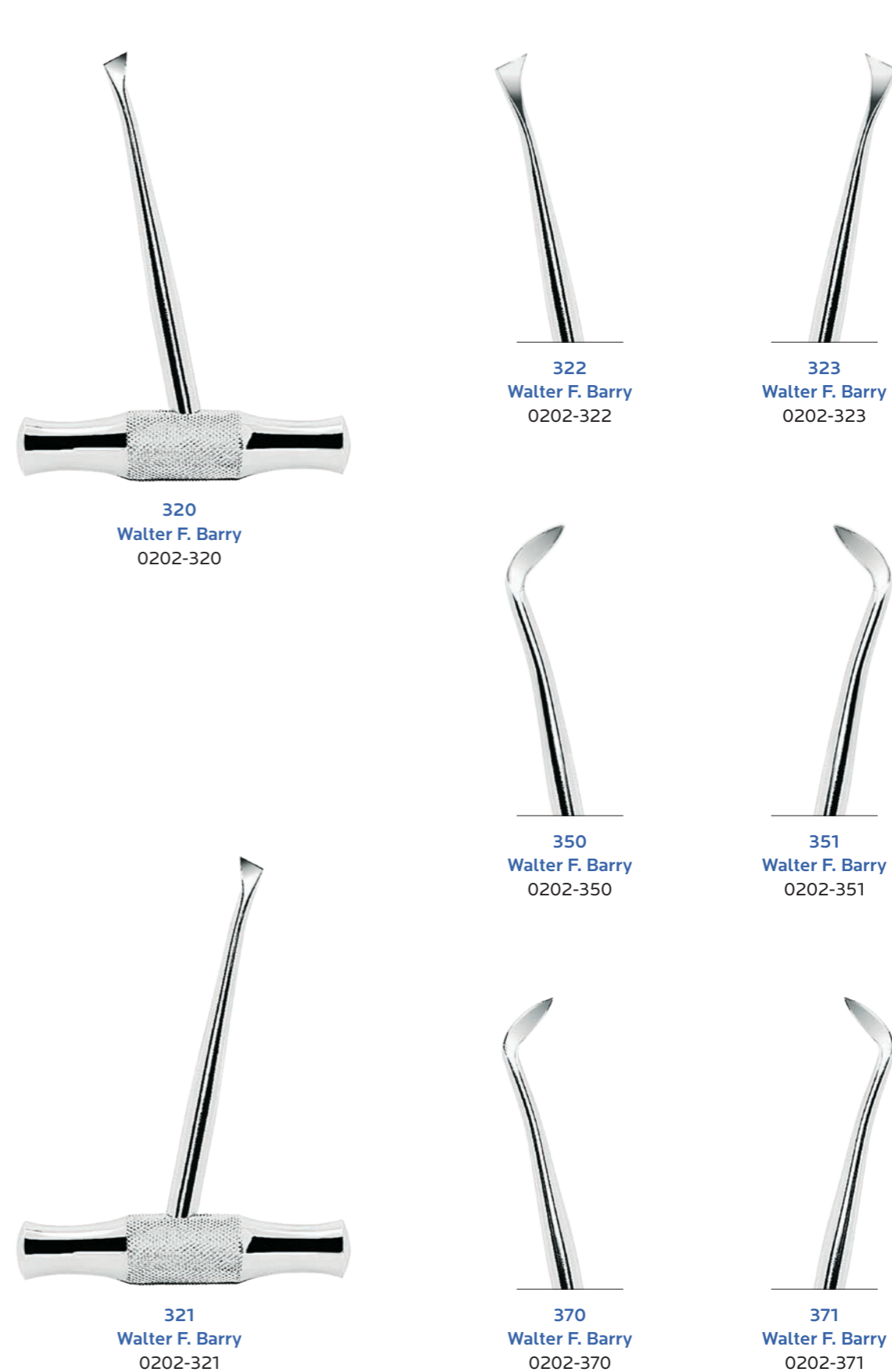

Root elevators with stainless steel handle



Root elevators with stainless steel handle



Root-tip picks with stainless steel handle



1 Heidbrink  
0291-1

Root-tip picks with stainless steel handle

Syndesmotomes with stainless steel handle



1 Heidbrink  
0290-1



2 Heidbrink  
0290-2



3 Heidbrink  
0290-3

2.8 mm



1 Warwick-James  
0294-1

2 mm



2 Warwick-James  
0294-2

2 mm



3 Warwick-James  
0294-3



1 Chompret  
0295-1



2 Chompret  
0295-2



4 Chompret  
0295-4



3 Chompret  
0295-3



3 Chompret  
W0298-3

AsaLady

Syndesmotomes

Syndesmotomes



11 cm  
0296-M



0  
0296-0

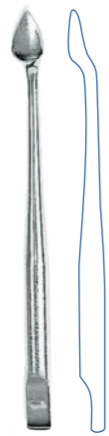

1  
0296-1



2  
0296-2



3  
0296-3



4  
0296-4



5  
0296-5



6  
0296-6



7  
0296-7



8  
0296-8



9  
0296-9



11  
0296-11

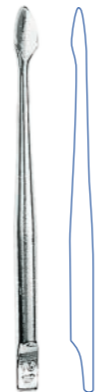

21  
0296-21

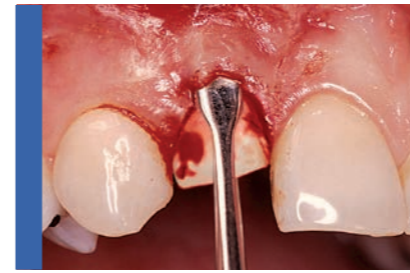

0296-22  
Asa Dental syndesmotomes offer the advantage of one handle and many easy to replace tips, helping solve the clinical case at hand. Usually very effective to prepare the field for atraumatic extraction, many of them can be conveniently used as periostomes.



22  
0296-22



23  
0296-23



24  
0296-24



25  
0296-25



26  
0296-26



27  
0296-27



28  
0296-28



29  
0296-29

Exciser



**PR1857-1**  
Used immediately following scalpel incision, it facilitates surgical incision and net release of the periosteal in bone exposure



PR1857-1  
Perfection

Periotomes



**1**  
ML1845-1



**2**  
ML1845-2



**3**  
ML1845-3

Syndesmotomes instruments kit

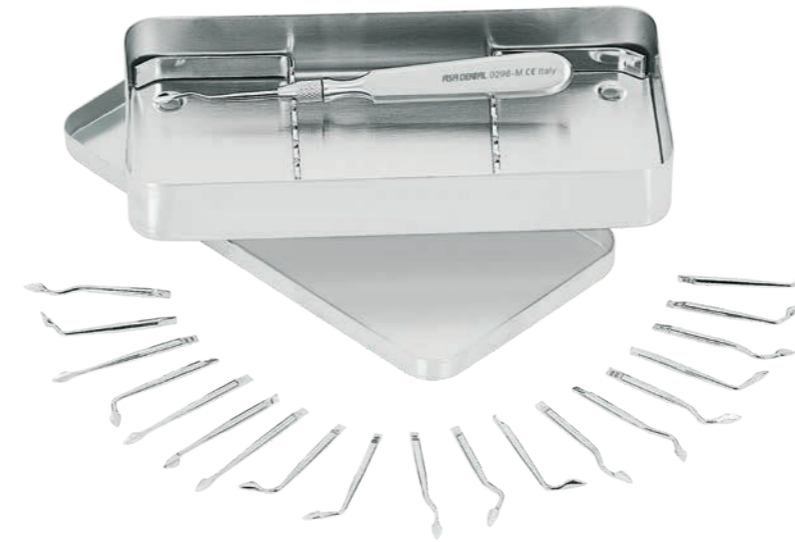

S0296



S0296-1



0297-1

	syndesmotome handle	0296-M
<b>0</b>	syndesmotome tip	0296-0
<b>1</b>	syndesmotome tip	0296-1
<b>2</b>	syndesmotome tip	0296-2
<b>3</b>	syndesmotome tip	0296-3
<b>4</b>	syndesmotome tip	0296-4
<b>5</b>	syndesmotome tip	0296-5
<b>6</b>	syndesmotome tip	0296-6
<b>7</b>	syndesmotome tip	0296-7
<b>8</b>	syndesmotome tip	0296-8
<b>9</b>	syndesmotome tip	0296-9
<b>11</b>	syndesmotome tip	0296-11
<b>21</b>	syndesmotome tip	0296-21
<b>22</b>	syndesmotome tip	0296-22
<b>23</b>	syndesmotome tip	0296-23
<b>24</b>	syndesmotome tip	0296-24
<b>25</b>	syndesmotome tip	0296-25
<b>26</b>	syndesmotome tip	0296-26
<b>27</b>	syndesmotome tip	0296-27
<b>28</b>	syndesmotome tip	0296-28
<b>29</b>	syndesmotome tip	0296-29
	insert frame tray	2700-G
	base tray	2700-L
	lid tray	2700-U

	syndesmotome handle	0296-M
<b>0</b>	syndesmotome tip	0296-0
<b>1</b>	syndesmotome tip	0296-1
<b>2</b>	syndesmotome tip	0296-2
<b>3</b>	syndesmotome tip	0296-3
<b>4</b>	syndesmotome tip	0296-4
<b>5</b>	syndesmotome tip	0296-5
<b>6</b>	syndesmotome tip	0296-6
<b>7</b>	syndesmotome tip	0296-7
<b>8</b>	syndesmotome tip	0296-8
<b>9</b>	syndesmotome tip	0296-9
<b>11</b>	syndesmotome tip	0296-11
	insert frame tray	2700-G
	base tray	2700-L
	lid tray	2700-U

syndesmotome tips holder  
20 holes  
70x40x12 mm

Extraction and oral surgery kit



Oral surgery kit  
SPR2781-S

	mouth mirror handle	ML2101
5	double sided mouth mirrors	22305
CP-15	periodontal pocket probes	0702L-15
5	scalpel handle and blade	0350-5
	exciser	PR1857-1
PR3	Prichard periosteal tissue pliers	MV1851-PR3 PR0625-2
23	Seldin retractor	1855-23
	Farabeuf retractor	2616-1
	Friedman root elevator	0229-2F
	Friedman root elevator	0229-1F
	Mini Friedman root elevator	0291-1F
	Mini Friedman root elevator	0291-2F
85	Lucas bone curette	ML2001-85
87	Lucas bone curette	ML2001-87
88	Lucas bone curette	ML2001-88
2R/2L	periodontal instrument	ML1806-2RL
4R/4L	periodontal instrument	ML1806-4RL
	Castroviejo needle holder	PR0460-15TC
2TC	gum scissors	0309-2TC
	sterilization cassette	2780-1B



S0100-3

33	extracting forcep	0100-33
51A	extracting forcep	0100-51A
67A	extracting forcep	0100-67A
79	extracting forcep	0100-79
1B	root elevator	0200-1
2F	root elevator	0201-2
3F	root elevator	0201-3
320	root elevator	0202-320
321	root elevator	0202-321



S0100-4

33	extracting forcep	0100-33
51A	extracting forcep	0100-51A
67A	extracting forcep	0100-67A
79	extracting forcep	0100-79
1B	root elevator	0200-1
2B	root elevator	0201-2
3B	root elevator	0201-3
	needle holders	0435-14TC
	needle holders	0425-16TC

Accessories

case for instruments and pliers



9002

1	case	9002
2	insert with elastic bands for 10 instruments	9002-2
3	insert with slots for 16 instruments	9002-3
4	insert for 6 extractive forceps	9002-1

autoclave instrument protection lubricant

Best instruments' autoclaving protection. Penetrates and lubricates all instruments' joints. Protects all dental and surgical hand instruments before and after sterilization. Instructions for use: oil all tips, joints and fastening of instruments before and after sterilization.



Steril Oil  
40 ml  
8002

Specific lubricant for dental and surgical instruments. The lubricant is designed to lubricate joints of all dental instruments (scissors, haemostatic and extracting forceps, bone rongeurs, needle holders etc.). Before and after sterilization it does not dry out during sterilization. Provides protection from corrosion and other deposits and ensures proper operation of the instruments.



Silicone  
40 ml  
8010



# IMPLANT SURGERY

MADE IN ITALY

## FROM LOSS TO RECOVERY

In the last decade, implantology has become an important part of clinical practice, helping dentists to improve the quality of life of many patients. Whilst implant treatment could often be a convenient alternative to conventional treatment options, in certain cases, it is the treatment of first choice for the rehabilitation of severe functional, anatomical or aesthetic problems arising from tooth loss. Asa Dental has developed a number of highly functional and easy to use instruments to help qualified dentists tackle even the most challenging clinical cases effectively and fully deliver all the advantages patients can benefit from Implant Surgery, including high stability, preservation of alveolar bone and long-term results. Our proficiency with design and manufacturing has led to educational collaboration with major dental institutions to grow competency in this branch of dentistry among dental professionals.

- E4 Scissors
- E5 Needle holders
- E7 Scalpels
- E10 Retractors
- E13 Sinus lift instruments
- E16 Mallets
- E16 Chisels
- E18 Osteotomes
- E21 Bone instruments and accessories
- E32 Pocket probes
- E32 Depth gauges
- E33 Aspirators
- E33 Calipers
- E34 Burs
- E35 Bone compactors
- E35 Pocket markers
- E36 Tissue pliers
- E37 Tweezers
- E38 Kits

Handle options

SINGLE END

Asa60  
(stainless steel)  
ø 6.0 mm



Leonardo ML  
(stainless steel)  
ø 7.0 mm



Perfection  
(stainless steel)  
ø 8.0 mm



● Magic Color MC  
(aluminum core and  
non-slip plastic)  
ø 8.0 / 10.5 mm



DOUBLE END

Asa60  
(stainless steel)  
ø 6.0 mm



Asa Light MV  
(stainless steel, hollow)  
ø 8.0 mm



Leonardo ML  
(stainless steel)  
ø 7.0 mm



Perfection  
(stainless steel)  
ø 8.0 mm



Octagonal  
(stainless steel)  
ø 5.5 mm



● Magic Color MC  
(aluminum core and  
non-slip plastic)  
ø 8.0 / 10.5 mm



standard instrument



instrument with tungsten carbide (TC) inserts

How to use

- CP-12 → pattern + scientific name
- MC0702-12 → Asa Dental code
- Magic Color MC → handle option

AsaLady

products ergonomically designed for women hands:

- smaller and lighter handles
- smaller finger holes
- reduced size
- code starts with "W" or "SW"

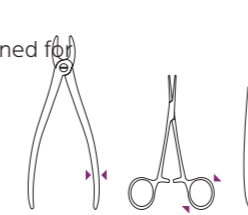

\* these products are not manufactured by Asa Dental and are distributed under manufacturer brand

Gum scissors



1 Goldman-Fox  
straight  
one blade serrated  
13 cm  
0304-1



2 Goldman-Fox  
curved  
one blade serrated  
13 cm  
0304-2



1TC Kelly  
straight  
16 cm  
0309-1TC



2TC Kelly  
curved  
16 cm  
0309-2TC



1 Metzenbaum-Delikat  
straight  
14.5 cm  
0322-1



2 Metzenbaum-Delikat  
curved  
14.5 cm  
0322-2

dissecting scissors

Needle holders



TC Mathieu  
14 cm  
0435-14TC



TC Mathieu  
17 cm  
0435-17TC



TC Lichtenberg  
17 cm  
0437-17TC



TC Castroviejo  
14 cm  
0445-14TC



TC Castroviejo  
14 cm  
0446-14TC



TC Castroviejo  
14 cm / 60°  
0448-14TC

Needle holders

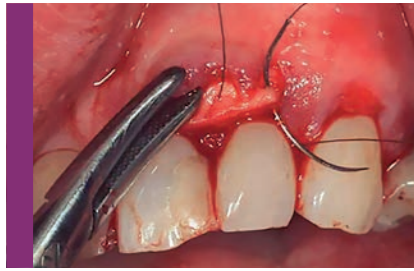

PR0460-15TC  
CURVED CASTROVIEJO NEEDLE HOLDER  
Allows maximum ease of handling during suturing.

Scalpel handles



TC Castroviejo  
with curved jaws  
15.5 cm  
PR0460-15TC



TC Micro-Barraquer  
18 cm  
0450-18TC



TC Micro-Barraquer  
with curved jaws  
18 cm  
0451-18TC



3  
13 cm  
0350-3



3  
12 cm  
W0349-3

AsaLady



3G  
13 cm  
0350-3G



8  
13 cm  
0350-8



7  
16 cm  
0350-7

Scalpel handles



**5**  
14.5 cm  
0350-5

**5A**  
14.5 cm  
0350-5A

Scalpel blades \*

100 pcs / box



**12D**  
double cutting edge  
0351-12D

**15C**  
0351-15C



**10**  
0351-10

**11**  
0351-11



**12**  
0351-12

**13**  
0351-13

**15**  
0351-15

Micro-blades \*

25 pcs (sterile) / box



**13.5 cm**  
0365-1



**4**  
0366-4



**7**  
0366-7

Orientable blade scalpel handle



**16 cm**  
0335-1

Scalpel blade remover



**16.5 cm**  
0352



**S0352**  
kit of 0352 scalpel blade remover +  
0335-1 orientable blade scalpel handle

**Disposable scalpels \***

100 pcs / box



0371-11



0371-10



0371-12



0371-15

**Retractors**

labial retractors



23.5 cm  
2628-1

vestibular a-matic retractor



25.5 cm  
2628-2

**Retractors**



20 cm  
2627

lip retractors



Sternberg  
14 cm  
2602-1



Orringer medium  
11 x 8 cm  
2609-2

**Retractors**

cheek retractor



University of Minnesota  
14 cm  
2604



Middeldorpf  
21.5 cm  
2620-1



21 cm  
2625-1



21 cm  
2626-1

ramus retractors for nasal spine

**Sinus lift instruments**



1  
MV1856-1  
Asa Light MV

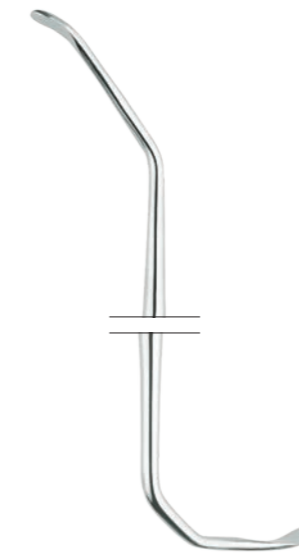

2  
MV1856-2  
Asa Light MV



3  
MV1856-3  
Asa Light MV

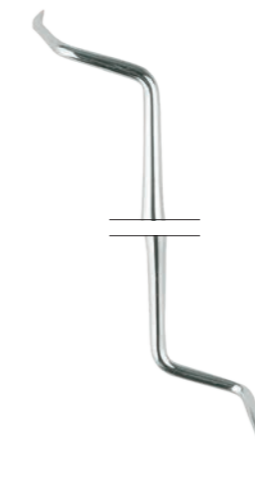

4  
MV1856-4  
Asa Light MV



5  
MV1856-5  
Asa Light MV

Sinus lift instruments



**6**  
MV1856-6  
Asa Light MV



**7**  
MV1856-7  
Asa Light MV

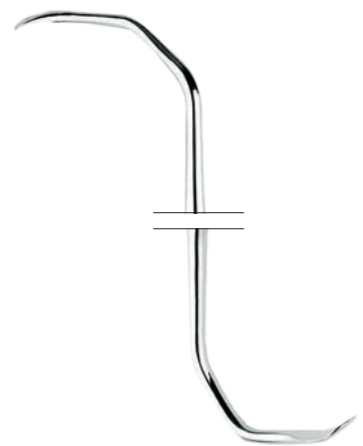

**8**  
MV1856-8  
Asa Light MV



**1**  
PR1859-1  
Perfection



**2**  
PR1859-2  
Perfection

Sinus lift instruments



**1**  
MV1855-1  
Asa Light MV



**2**  
MV1855-2  
Asa Light MV

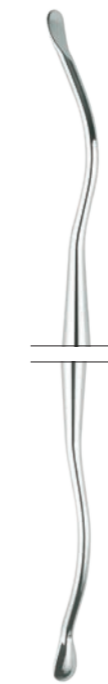

**4**  
MV1855-4  
Asa Light MV

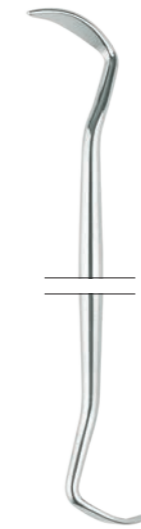

**3**  
MV1855-3  
Asa Light MV

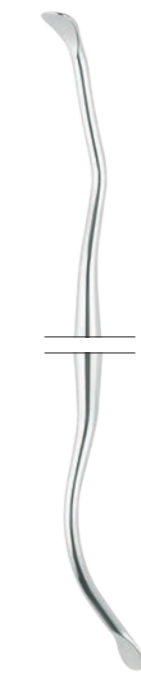

**5**  
MV1855-5  
Asa Light MV



**6**  
MV1855-6  
Asa Light MV

Mallets

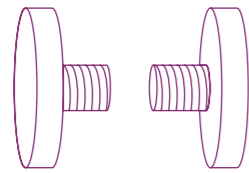

1881-R  
#2 Teflon inserts  
autoclavable  
max 120°



Partsch  
19 cm  
1880  
lead filled



Mead  
19.5 cm  
1881

Freer single cut chisels

2 mm



1 Freer  
1839-1



0.7 mm

4 mm



2 Freer  
1839-2



1.3 mm

6.3 mm



3 Freer  
1839-3

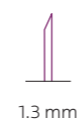

1.3 mm

Graduated chisels

3.8 mm

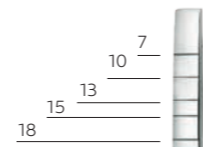

1  
straight  
1840-1

3.8 mm

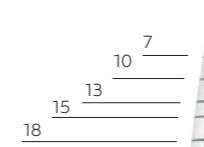

2  
curved  
1840-2

7.5 mm

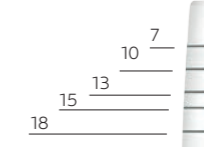

3  
straight  
1840-3

7.5 mm

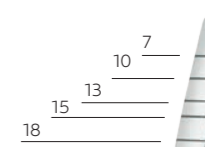





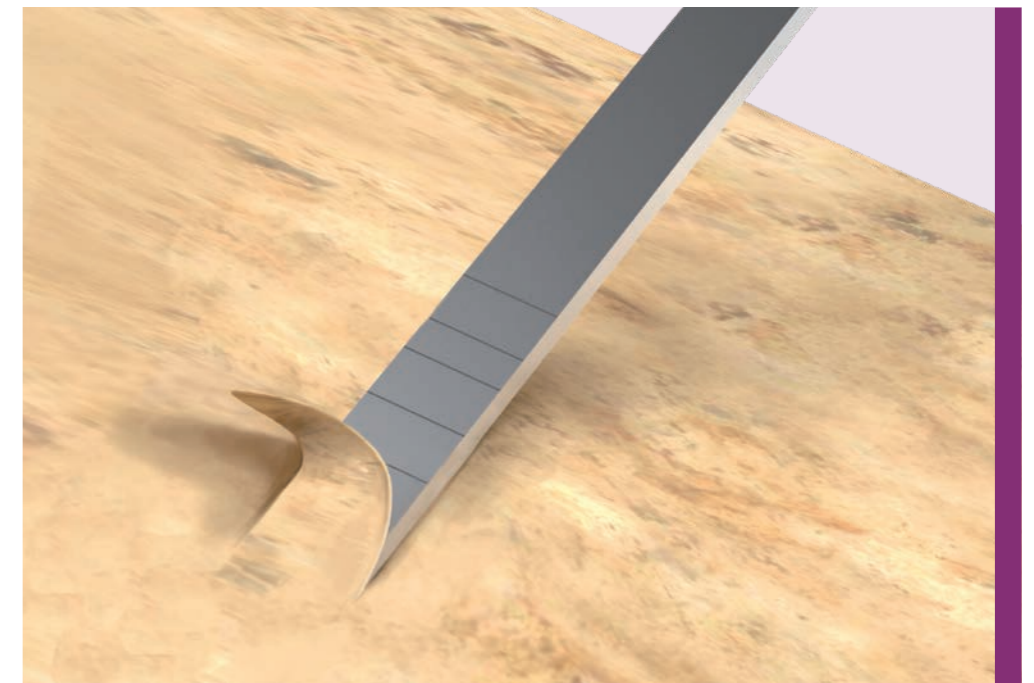













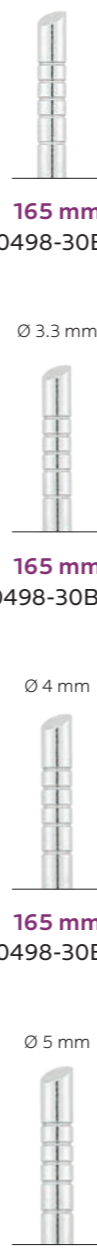

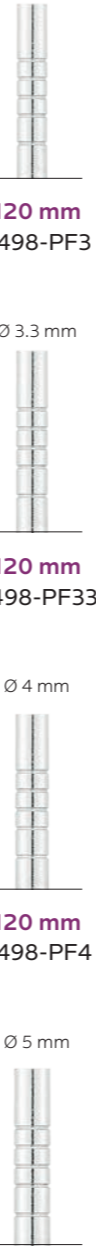









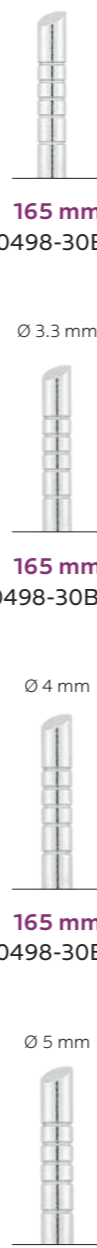

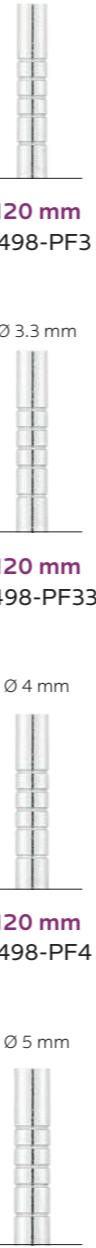









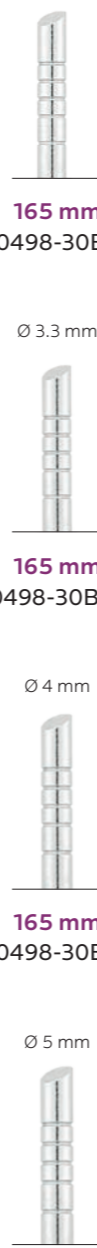

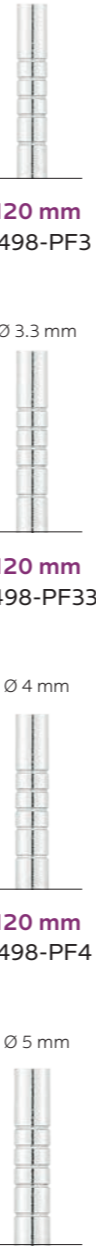

4  
curved  
1840-4

1840-1



Osteotomes

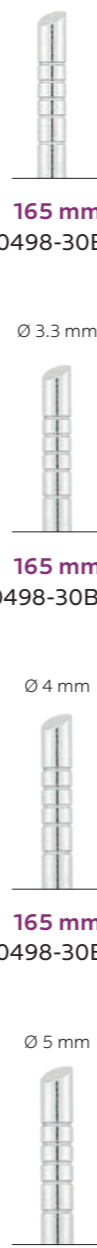

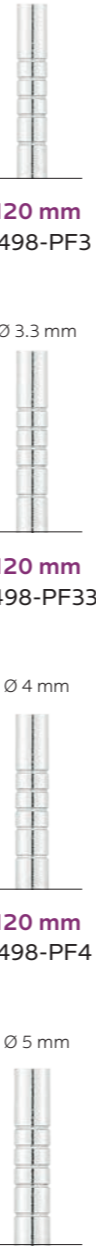



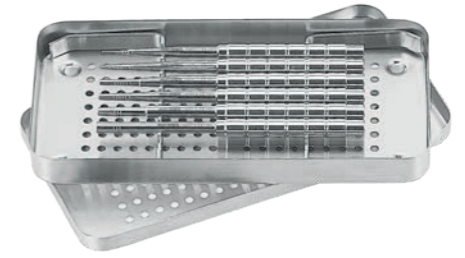



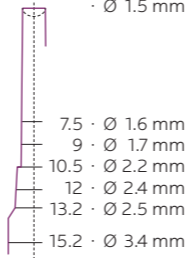

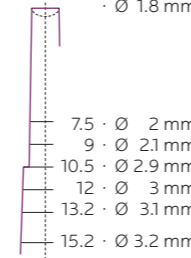
annular osteotomes with setting point

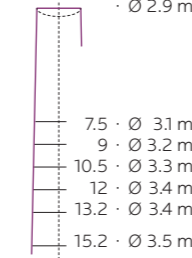
 CONCAVE Ø 3 mm  165 mm 0498-1B3	 CONCAVE Ø 3.3 mm  165 mm 0498-1B4	 CONCAVE Ø 3 mm  165 mm 0498-2C3	 CONCAVE Ø 3.3 mm  165 mm 0498-2C4	 ANGULAR Ø 3 mm  165 mm 0498-30B3	 FLAT Ø 3 mm  165 mm 0498-30B4
 CONCAVE Ø 3 mm  165 mm 0498-1B3	 CONCAVE Ø 3.3 mm  165 mm 0498-1B4	 CONCAVE Ø 3 mm  165 mm 0498-2C3	 CONCAVE Ø 3.3 mm  165 mm 0498-2C4	 ANGULAR Ø 3 mm  165 mm 0498-30B3	 FLAT Ø 3 mm  165 mm 0498-30B4
 CONCAVE Ø 3 mm  165 mm 0498-1B3	 CONCAVE Ø 3.3 mm  165 mm 0498-1B4	 CONCAVE Ø 3 mm  165 mm 0498-2C3	 CONCAVE Ø 3.3 mm  165 mm 0498-2C4	 ANGULAR Ø 3 mm  165 mm 0498-30B3	 FLAT Ø 3 mm  165 mm 0498-30B4
 CONCAVE Ø 3 mm  165 mm 0498-1B3	 CONCAVE Ø 3.3 mm  165 mm 0498-1B4	 CONCAVE Ø 3 mm  165 mm 0498-2C3	 CONCAVE Ø 3.3 mm  165 mm 0498-2C4	 ANGULAR Ø 3 mm  165 mm 0498-30B3	 FLAT Ø 3 mm  165 mm 0498-30B4

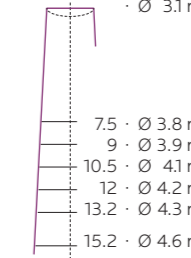
Osteotomes

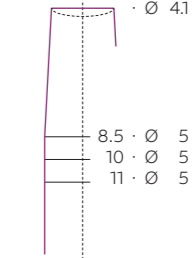

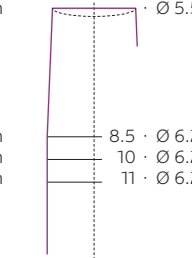
1 · 2 · 3 · 4 · 5 · 6  
 S0495-6  
 set of 6  
 with tray S2702

CONCAVE Ø 1.5 mm  7.5 · Ø 1.6 mm 9 · Ø 1.7 mm 10.5 · Ø 2.2 mm 12 · Ø 2.4 mm 13.2 · Ø 2.5 mm 15.2 · Ø 3.4 mm  155 mm 0495-1	CONCAVE Ø 1.8 mm  7.5 · Ø 2 mm 9 · Ø 2.1 mm 10.5 · Ø 2.9 mm 12 · Ø 3 mm 13.2 · Ø 3.1 mm 15.2 · Ø 3.2 mm  155 mm 0495-2	CONCAVE Ø 2.9 mm  7.5 · Ø 3.1 mm 9 · Ø 3.2 mm 10.5 · Ø 3.3 mm 12 · Ø 3.4 mm 13.2 · Ø 3.4 mm 15.2 · Ø 3.5 mm  155 mm 0495-3	CONCAVE Ø 3.1 mm  7.5 · Ø 3.8 mm 9 · Ø 3.9 mm 10.5 · Ø 4.1 mm 12 · Ø 4.2 mm 13.2 · Ø 4.3 mm 15.2 · Ø 4.6 mm  155 mm 0495-4	CONCAVE Ø 4.1 mm  8.5 · Ø 5 mm 10 · Ø 5 mm 11 · Ø 5 mm  155 mm 0495-5	CONCAVE Ø 5.5 mm  8.5 · Ø 6.2 mm 10 · Ø 6.2 mm 11 · Ø 6.2 mm  155 mm 0495-6
--	--	--	--	--	--

Osteotomes

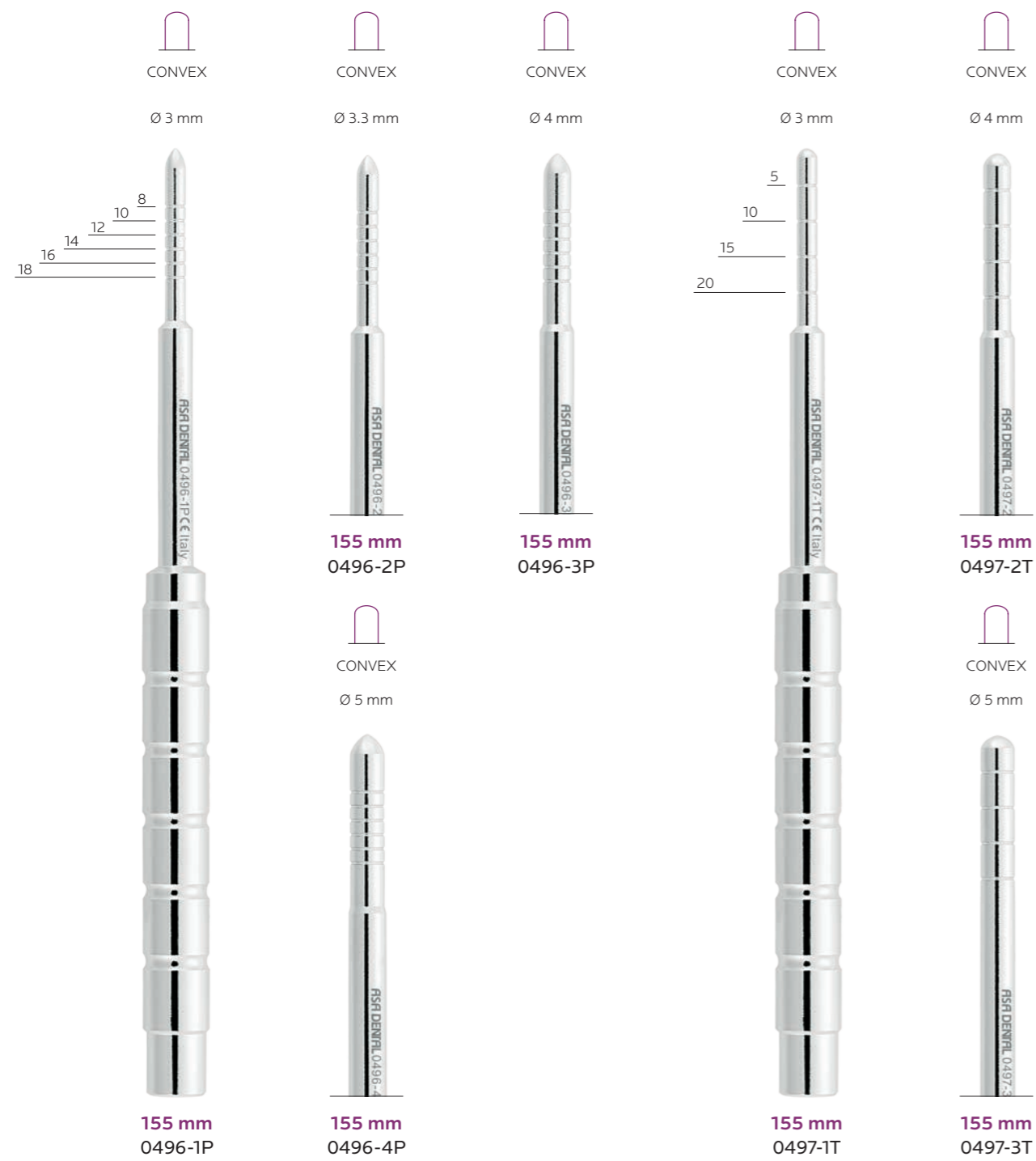

Bone files

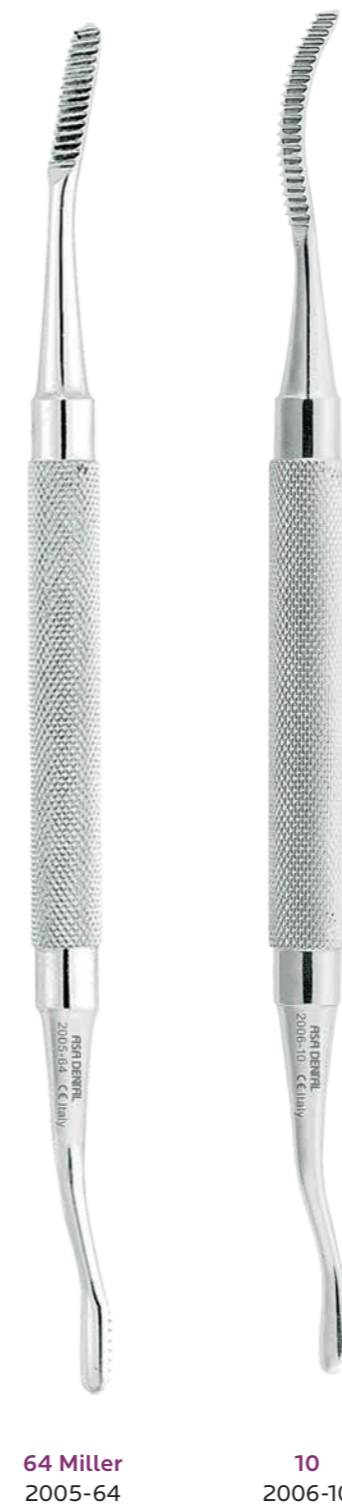

Bone cures

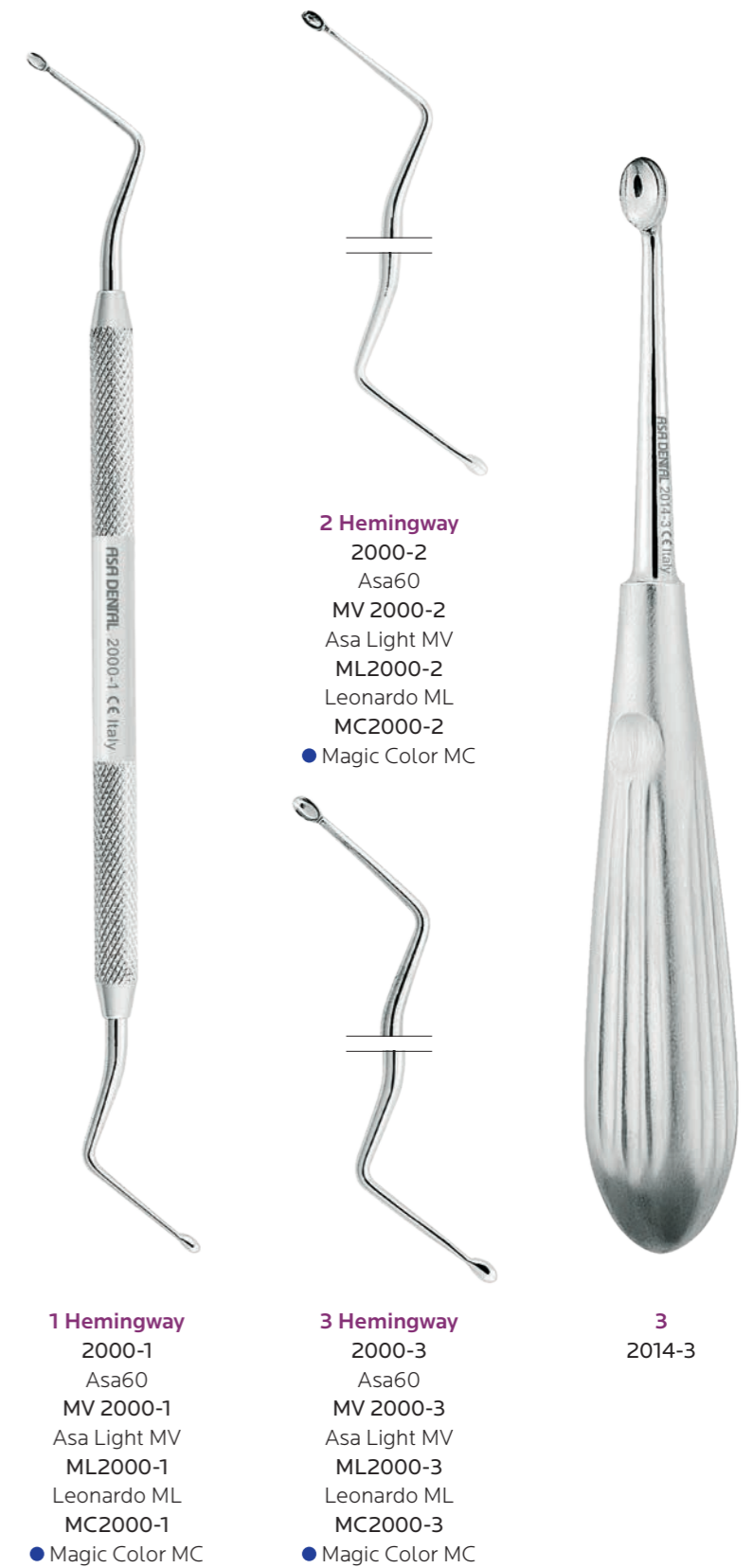

Exciser

Periosteal elevators

Periosteal elevators

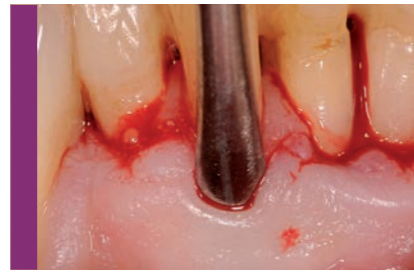

**PR1850-M**  
PERIOSTEAL ELEVATOR  
WITH ROUNDED TIP AND LANCE TIP  
Allows efficient release of even  
the most restricted and scalloped  
gingival margins.



**1**  
PR1857-1  
Perfection



3 mm  
LANCIE TIP  
**Buser**  
PR1850-M  
Perfection



**Beale**  
5114-1  
Octagonal



**GF Goldman-Fox**  
MV1850-GF  
Asa Light MV



**9A Allen**  
MV1850-9A  
Asa Light MV



**M7 Molt**  
MV1850-M7  
Asa Light MV

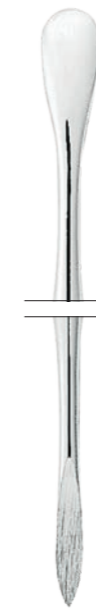

**M9 Molt**  
MV1850-M9  
Asa Light MV



**M8 Molt**  
MV1850-M8  
Asa Light MV



**2 Hourigan**  
MV1851-2  
Asa Light MV



**PR3 Prichard**  
MV1851-PR3  
Asa Light MV

Periosteal elevators

Periosteal elevators

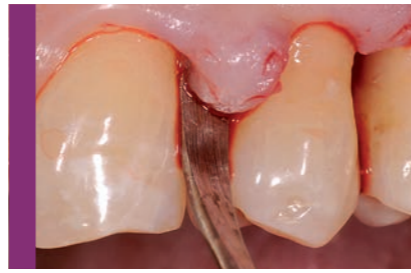

PR1850-1  
PAPILLA PERIOSTEAL  
for atraumatic release and  
lifting of the gingival papilla  
in papilla restorative  
techniques.

2 mm

2.5 mm



**Partsch**  
14.5 cm  
1849-1  
Asa60

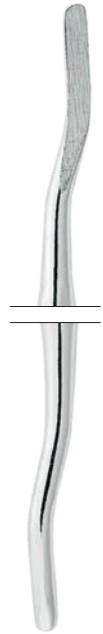

**1 Hopkins**  
MV1852-1  
Asa Light MV

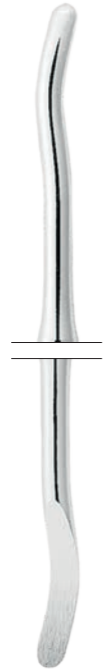

**2 Hopkins**  
MV1852-2  
Asa Light MV

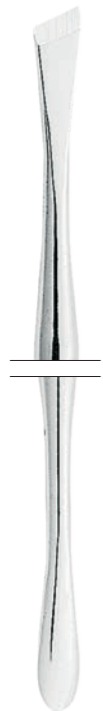

**3 Mead**  
MV1854-3  
Asa Light MV

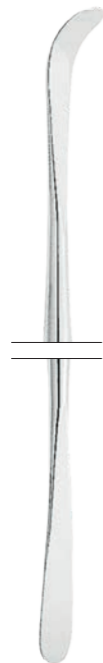

**15 Freer**  
MV1853-15  
Asa Light MV

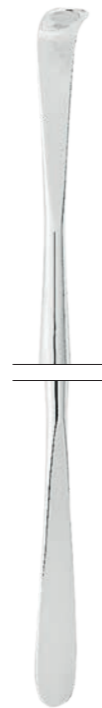

**16 Freer**  
MV1853-16  
Asa Light MV



**17 cm**  
PR1850-1  
Perfection



**22 Seldin**  
retractor  
1855-22



**23 Seldin**  
retractor  
1855-23



**König**  
15.5 cm  
1858-1



**Williger**  
17 cm  
1856-1



**Williger**  
16 cm  
1856-2



**Williger**  
16 cm  
1857-1



**Williger**  
13 cm  
1857-2

Mucotomes

3 mm



straight  
1844-3

4 mm



straight  
1844-4

5 mm



straight  
1844-5

6 mm



straight  
1844-6

3 mm



curved  
1844-3C

4 mm



curved  
1844-4C

5 mm



curved  
1844-5C

6 mm



curved  
1844-6C

Bone injector

Ø 2.5 mm



16 cm  
0490-1

Ø 4.5 mm



16 cm  
0490-2

Bone mill



17 cm  
1846

Bone scrapers

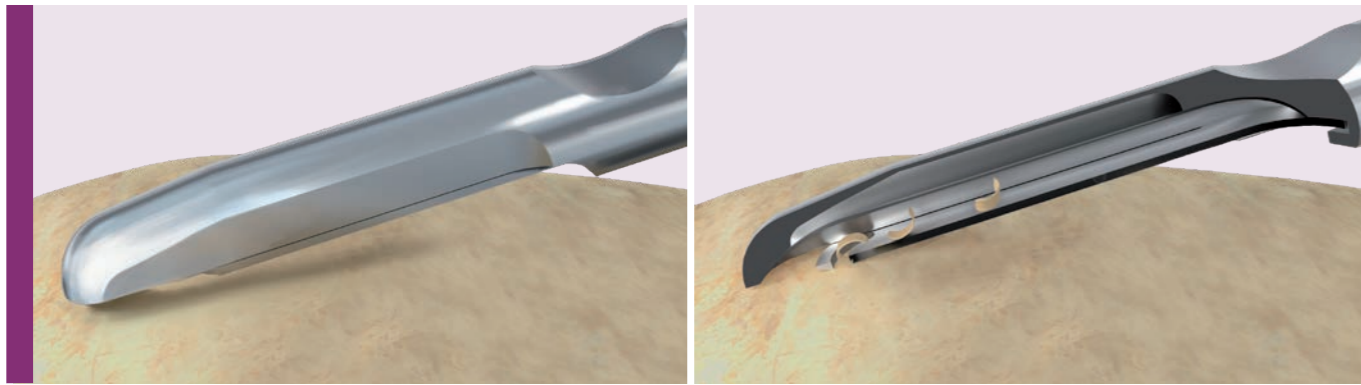

0494-1



straight  
15 cm  
0494-1  
blade included



straight  
0494-1R  
blade for  
0494-1



curved  
15 cm  
0494-2  
blade included



straight  
0494-2R  
blade for  
0494-2

Periotomes



1  
ML1845-1  
Leonardo ML

2  
ML1845-2  
Leonardo ML

3  
ML1845-3  
Leonardo ML

Bone applicator



MV1231-1  
Asa Light MV

Bone/soft tissue nipper

small size for use  
in limited access areas



Goldman-Fox  
10 cm  
0103-60

Bone rongeurs

Bone thickness gauge

Membrane placement instrument



Luer  
15 cm  
0103-10



Mini Friedman  
12 cm  
0103-25



Blumenthal  
15 cm  
0103-30



Blumenthal  
14.5 cm  
0103-31

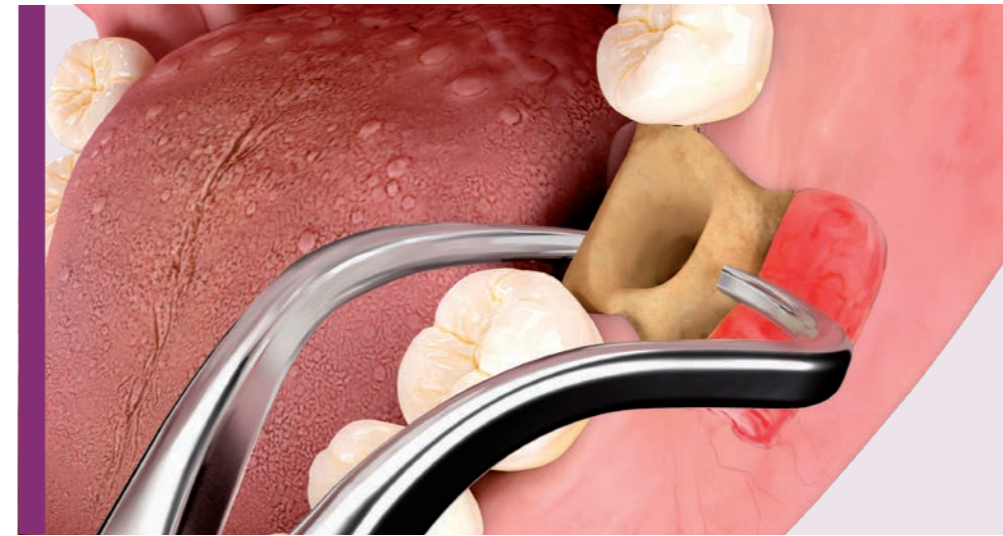

0491-2



17.5 cm  
0491-1



15.5 cm  
0491-2



Buser  
MV1883  
Asa Light MV

Bone well

Pocket probes

Depth gauge

Aspirators  
bone filters

Caliper



h. 3 cm  
1030-4



CP-11  
0702L-11  
Asa60



CP-12  
0702L-12  
Asa60  
MC0702-12  
● Magic Color MC



CP-12S  
0702L-12S  
Asa60



ML0804-1



surgical saliva ejector  
bone filter  
autoclavable

16.5 cm  
0493-1

spare filter  
medium grid  
for 0493-1



2.7 cm  
0493-2



stainless steel bone filter  
to be used with the  
disposable saliva ejector



0493-5

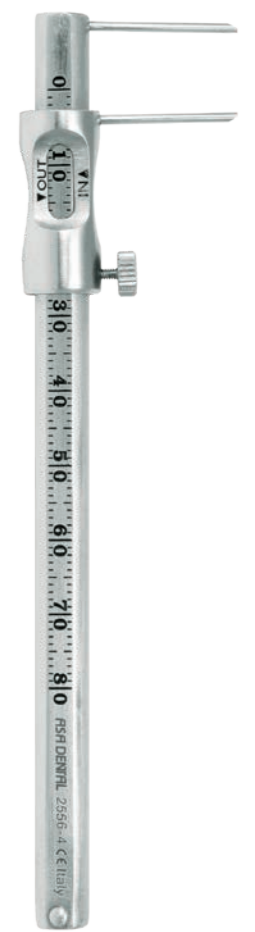

2556-4

**Trepine graduated burs \***

Inside Ø 2,8 mm



1841-1

Inside Ø 5,0 mm



1841-2

Inside Ø 7,0 mm



1841-3

Inside Ø 10,0 mm



1841-4

**Burs holder**

aluminum, suitable for steam sterilizing

with rim 24 holes CA  
(big burs)



AL2760-2

with rim 24 holes FG/CA  
(small/big burs)



AL2760-3

48 holes CA  
(big burs)



AL2762-2

colored silicone with plastic cover

lid  
non autoclavable



AL2761-U

autoclavable  
atoxic food silicon

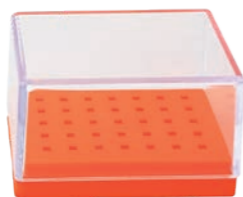

Orange  
S2760-A

autoclavable  
atoxic food silicon

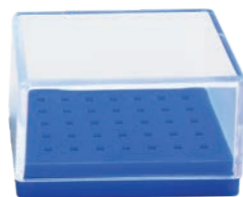

Blue  
S2760-C

**Bone compactors**



1  
MV1230-1

2  
MV1230-2

**Periodontal pocket markers**



1 (Crane-Kaplan)  
Goldman-Fox  
15 cm  
0650-1

2 (Crane-Kaplan)  
Goldman-Fox  
15 cm  
0650-2

Tissue pliers

suture pliers

Membrane holding tweezers

Implant holding tweezers



1  
Adson  
12 cm  
0620-1



1  
Adson 1x2  
12 cm  
0621-1



1  
Semken-Taylor  
12.5 cm  
0630-1



2  
Semken-Taylor  
12.5 cm  
0630-2



16 cm  
PR0625-2



17 cm  
PR0625-3



10.5 cm  
0660-1



9 cm  
0660-2  
with delicate ring tips



16.5 cm  
0661-1



14.5 cm  
0661-2



14.5 cm  
0661-3

Implant surgery instruments

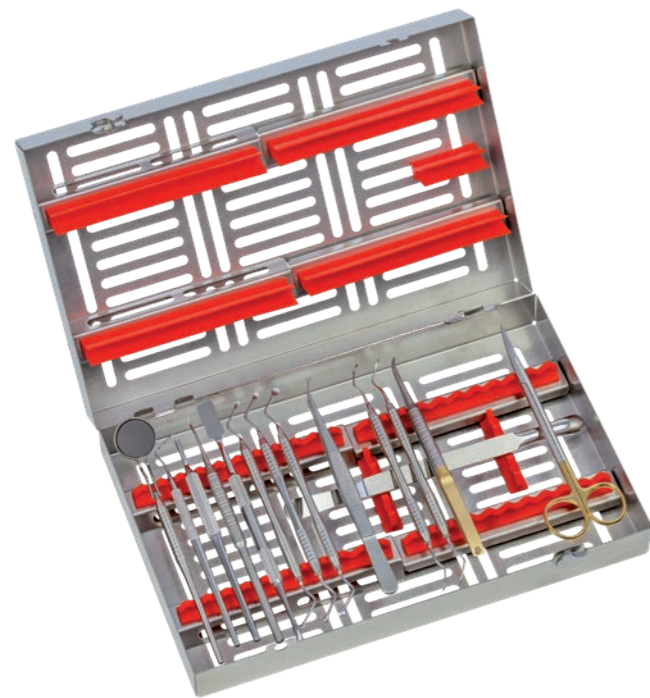

Implant surgery kit  
SPR2781-I

	mouth mirror handle	ML2101
5	double sided mouth mirrors	22305
CP-15	periodontal pocket probes	0702L-15
5	scalpel handle and blade	0350-5
	exciser	PR1857-1
PR3	Prichard periosteal	MV1851-PR3
23	Seldin retractor	1855-23
85	Lucas bone curette	ML2001-85
87	Lucas bone curette	ML2001-87
88	Lucas bone curette	ML2001-88
	tissue pliers	PR0625-2
2R/2L	periodontal instrument	ML1806-2RL
4R/4L	periodontal instrument	ML1806-4RL
	Castroviejo needle holder	PR0460-15TC
2TC	gum scissors	0309-2TC
	sterilization cassette	2780-1R

Implant surgery instruments



Sinus lift mini kit  
SPR0495

	osteotomes	0495-1
	osteotomes	0495-2
	osteotomes	0495-3
	osteotomes	0495-4
	osteotomes	0495-5
	osteotomes	0495-6
	mead mallet	1881
	sterilization cassette	2770-1R



Sinus lift maxi kit  
SPR0496

	sinus lift	PR1859-1
	sinus lift	PR1859-2
	bone applicator	MV1231-1
	bone injector	0490-1
2	sinus lift curette	MV1856-2
	sterilization cassette	2770-3R



288 x 182 x h. 60 mm  
S2780-IMP

	bone well	1030-4
	bone mill	1846
3	bone curettes	2014-3
	straight bone scraper	0494-1
	bone injector	0490-2
	bone injector	0490-1
1	compactor	MV1230-1
2	compactor	MV1230-2

Implant surgery instruments

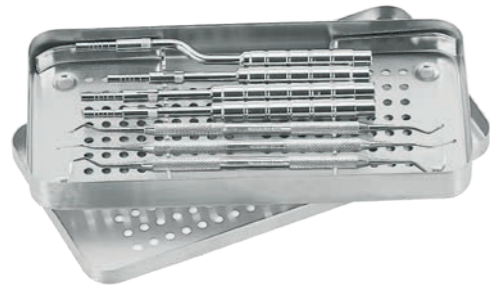

Sinus lift mini kit  
S0498-8

<b>1B4</b>	concave osteotome sinus lift	0498-1B4
<b>2C4</b>	concave osteotome sinus lift	0498-2C4
<b>30B4</b>	angular osteotome sinus lift	0498-30B4
<b>PF4</b>	flat osteotome sinus lift	0498-PF4
<b>U15/30</b>	Towner-Jacquette scaler	1902-2
<b>1</b>	Goldman-Fox Universal scaler	1809-1
<b>31/32</b>	Jacquette curette	1831-32
<b>87</b>	Lucas bone curette	2001-87
	instruments tray	S2702

Implant surgery instruments

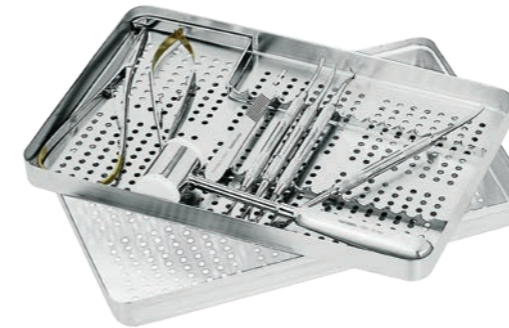

S3003-9

<b>M9</b>	Molt periosteal	MV1850-M9
<b>PR3</b>	Prichard periosteal	MV1851-PR3
<b>GF</b>	Goldman-Fox periosteal	MV1850-GF
<b>15K/16K</b>	Kirkland knife	MV1803-D
	Mead mallet	1881
	Castroviejo needle holder	0446-14TC
	Mathieu needle holder	0435-17TC
<b>3</b>	scalpel handle	0350-3
	instrument tray	S2722-1



Goracci kit  
S3001-20

	gum scissors straight	0300-1
	Flagg cotton & dressing pliers	0601-1
<b>23/17A</b>	explorer d. e.	0704-23D2
<b>2</b>	cement spatulas double ended	0903-2
<b>2</b>	Heidemann separating spatulas	1101-2
<b>2</b>	filling instrument	1200-2
<b>1L</b>	filling instrument	1202-1L
<b>2L</b>	filling instrument	1202-2L
<b>1T</b>	Tanner filling instrument	1211-1T
	placement instrument	1301
<b>1/2</b>	Hollenback amalgam cavers	1500-02
<b>1</b>	cleodis discoids	1600-1
<b>26</b>	black margin trimmer	1601-1
<b>27</b>	black margin trimmer	1601-2
<b>1</b>	double ended excavator	1700-1
<b>2</b>	double ended excavator	1700-2
<b>3</b>	double ended excavator	1700-3
<b>4</b>	double ended excavator	1700-4
	mirror handle	2102-IN
<b>5</b>	mouth mirror plane	2200-5
	instruments tray	S2721-2



S3003-11

<b>3</b>	scalpel handle	0350-3
	Sternberg retractor	2602-1
<b>2</b>	Goldman-Fox scissor	0304-2
<b>M9</b>	Molt periosteal	MV1850-M9
<b>PR3</b>	Prichard periosteal	MV1851-PR3
	Crite-Wood needle holder	0415-15TC
<b>1</b>	Semken Taylor tissue plier	0631-1
<b>23</b>	explorer	0700-23
	mouth mirror handle	2102-IN
<b>5</b>	mouth mirror plane	2200-5
<b>11</b>	disposable blades (100 pcs)	0351-11
	instrument tray	S2722-1

**6**  
**F**

**RESTORATIVE**

MADE IN ITALY

MAKE PEOPLE SMILE

This simple yet powerful idea drives every decision we take at Asa Dental. Whenever we choose materials, technologies, designs or manufacturing processes we make sure they will help dental professionals make people smile, anywhere in the world. Our Restorative instruments are first the result of a mindset, only after advanced technologies and skilled hands shape them.

This is how we manufacture durable excavators, precise carvers, effective burnishers, innovative isolation instruments and all the other products that allow the best practitioners to deliver aesthetically and functionally superior results.

- F2 Vision dental dam
- F4 Isolation clamps
- F8 Isolation instruments
- F13 Excavators
- F18 Cavity preparation instruments
- F20 Amalgam wells
- F20 Amalgam carriers
- F22 Spatulas
- F25 Filling instruments
- F36 Carvers
- F39 Operative instruments
- F40 Crown instruments
- F44 Hemostats
- F45 Scissors
- F46 Matrix
- F48 Composite instruments



**Vision® Shade**

dental dam

pack of 60 rubber dams  
(black, mint-flavored dams)



VS3045

stainless steel dam frame  
100x150 mm



VV3040-2

stainless steel magnetic locking tray



VV2731-6

stainless steel magnetic locking tray  
with 6 clamps



SVS2731-6

clamps



**210**  
winged  
perfect for anterior teeth  
VS3051-210



**12A**  
winged, serrated  
for lower right/upper left molar  
VS3052-12A



**W4**  
wingless  
for upper/lower molars  
VS3052-W4



**2**  
winged  
for lower/upper premolars  
VS3052-2



**13A**  
winged, serrated  
for lower left/upper right molar  
VS3052-13A



**W8**  
wingless  
for upper/lower molars  
VS3052-W8

stainless steel clamp forceps



VV3030

stainless steel punch forceps



VV3033

stainless steel punching template

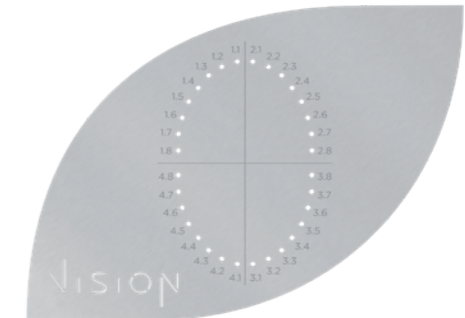

VV3035

marker suitable for food contact



VVPEN

Vision Shade Kit



SVS3000

**Tooth numbering**

Maxillary teeth	pattern
18   17   16	4   W4   8   W8   8A   W8A   12A   14   14T W14   14A   W14A   26   51   205   202
15   14	0   W0   1   1T   W1   2A   2AT W2A   29
13   12   11   21   22   23	9   9T   212   210
24   25	0   W0   1   1T   W1   2A   2AT W2A   29
26   27   28	4   W4   8   W8   8A   W8A   13A   14   14T W14   14A   W14A   26   51
Mandibular teeth	pattern
38   37   36	3   W3   7   W7   8A   W8A   13A   14   14T W14   14A   W14A
35   34	0   W0   2A   2AT   W2A   2   2T   W2   29
33   32   31   41   42   43	00   9   9T   212   210
44   45	0   W0   2   2T   W2   2A -2AT   W2A   29
46   47   48	3   W3   7   W7   12A   14   14T   W14 14A   W14A

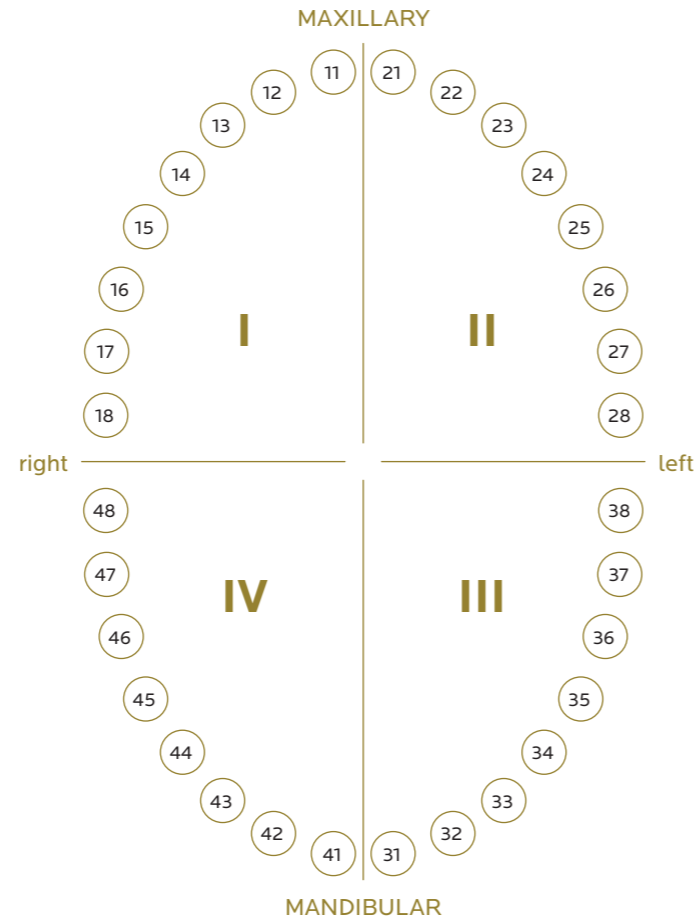

**Classification**

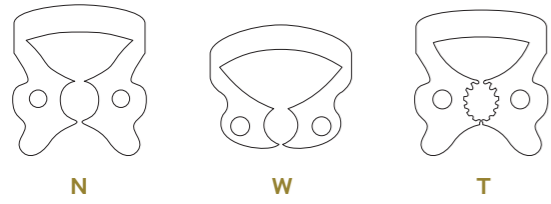

- N** = Standard (winged clamp)
- W** = Wingless (wingless clamp)
- T** = Tiger (serrated jaws)

**Rubber dam clamps**

ANTERIOR

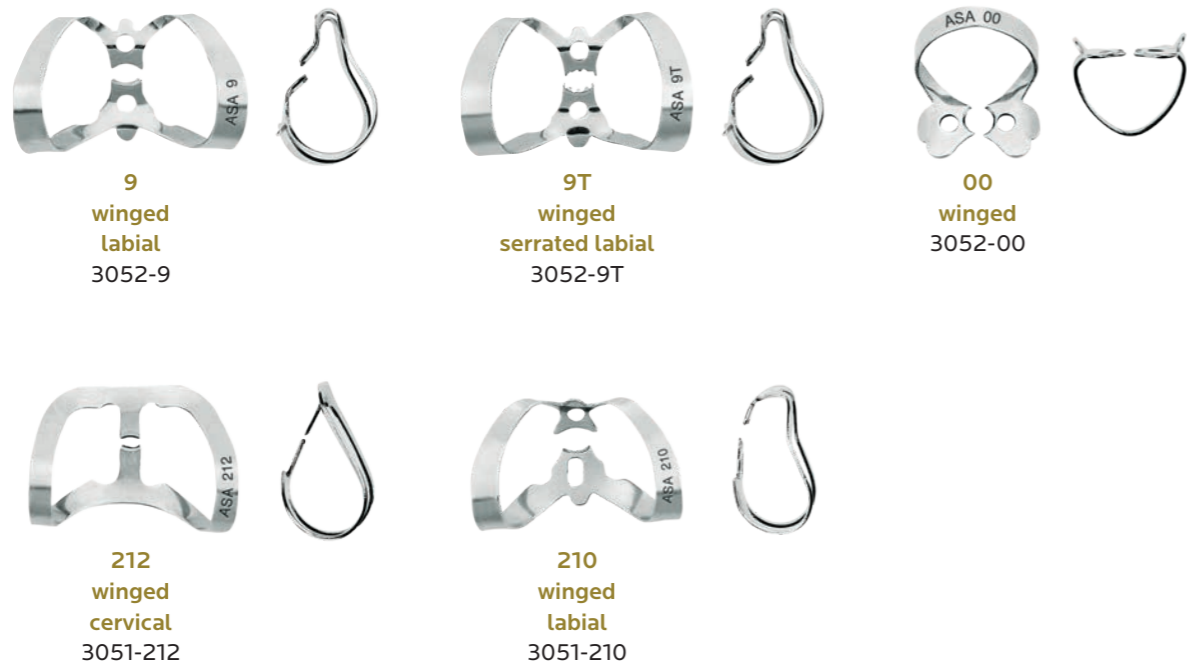

PREMOLARS

for elongated teeth or with small necks



for general use upper with adjustable jaws according to gingival line shapes



for premolars, with large necks



for general purpose lower premolars



primarily for lower premolars



MOLARS

for small lower molars



**3**  
winged  
3052-3



**W3**  
wingless  
3052-W3



for square lower molars



**7**  
winged  
3052-7



**W7**  
wingless  
3052-W7



for molar roots



**8A**  
winged  
3052-8A



**W8A**  
wingless  
3052-W8A



for round molars,  
partially broken,  
undersized or inclined



**14**  
winged  
3052-14



**14T**  
winged, serrated  
3052-14T



**W14**  
wingless  
3052-W14



for upper molars



**26**  
wingless  
3051-26



**51**  
wingless  
3051-51

MOLARS

for small upper molars  
with round collars



**4**  
winged  
3052-4



**W4**  
wingless  
3052-W4



for round upper molars



**8**  
winged  
3052-8



**W8**  
wingless  
3052-W8



for partially broken  
lower molars



**12A**  
winged, serrated  
3052-12A



**13A**  
winged, serrated  
3052-13A



for large molars,  
partially broken,  
irregularly shaped  
or inclined



**14A**  
winged  
3052-14A



**W14A**  
wingless  
3052-W14A



for large upper molars



**202**  
winged  
3051-202



**205**  
winged  
3051-205

Rubber dam instruments

AsaLady

- products ergonomically designed for women hands:
- smaller and lighter handles
  - smaller finger holes
  - reduced size
  - code starts with "W" or "SW"

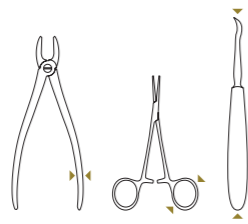

latex dam  
vacuum packed  
36 pcs / pack

15x15 cm (6"x 6")  
3045



punch forceps



Ainsworth  
17 cm  
3032



Ainsworth  
17 cm  
W3036



Ivory  
16.2 cm  
3033

Rubber dam instruments



Rubber dam placed on an upper molar

rubber dam frame  
stainless steel

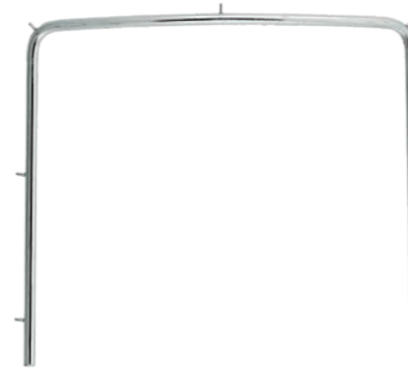

10x10 cm  
3040-1

rubber dam frame  
plastic  
sterilizable  
x-rays compatible



3041-1

clamp forceps



Ivory lightweight  
17 cm  
3030



Ivory lightweight  
16 cm  
W3035



Brewer  
17,5 cm  
3031



Stoke  
17,5 cm  
3034

Rubber dam instrument kit



S3000

rubber dam instrument kit realised according to the instruction of Prof. GUIDO GORACCI, Senior Professor in the Department of Conservative Dentistry of Rome University, "LA SAPIENZA"

	stainless steel rubber dam frame	3040-1
	Brewer clamp forceps	3031
	Ivory punch forceps	3033
60	wingless bicuspid clamp	3050-60
26	wingless molar clamp	3051-26
51	wingless molar clamp	3051-51
29	wingless bicuspid clamp	3051-29
202	winged molar clamp	3051-202
205	winged molar clamp	3051-205
212	winged cervical clamp	3051-212
210	winged labial clamp	3051-210
	stainless steel rubber dam clamp tray	2731-1
	stainless steel instrument tray base	2720-L
	stainless steel instrument tray lid	2720-U
	stainless steel insert frame	2730-3

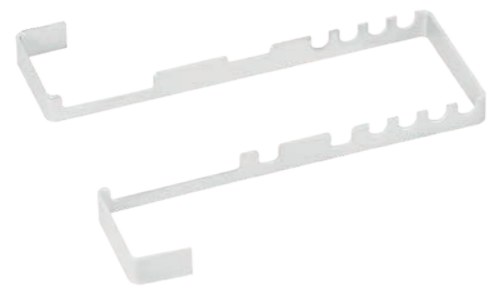

2730-3

stainless steel insert frame

Rubber dam instrument kit



S2731-1

stainless steel rubber dam clamp tray with 8 different clamps

60	wingless bicuspid clamp	3050-60
26	wingless molar clamp	3051-26
51	wingless molar clamp	3051-51
29	wingless bicuspid clamp	3051-29
202	winged molar clamp	3051-202
205	winged molar clamp	3051-205
212	winged cervical clamp	3051-212
210	winged labial clamp	3051-210
	stainless steel rubber dam clamp tray	2731-1



S2731-12

stainless steel rubber dam clamp tray with 12 different clamps

212	winged cervical clamp	3051-212
00	winged premolar clamp	3052-00
0	winged premolar clamp	3052-0
1	winged premolar clamp	3052-1
2A	winged premolar clamp	3052-2A
3	winged molar clamp	3052-3
7	winged molar clamp	3052-7
8	winged molar clamp	3052-8
8A	winged molar roots clamp	3052-8A
12A	serrated and winged molar clamp	3052-12A
13A	serrated and winged molar clamp	3052-13A
14	winged molar clamp	3052-14
	stainless steel rubber dam clamp tray	2731-1



2731-1

stainless steel rubber dam clamp tray (without clamps)

Handle options

SINGLE END

Asa35  
(stainless steel)  
ø 3.5 mm



Asa60  
(stainless steel)  
ø 6.0 mm



Octagonal  
(stainless steel)  
ø 5.5 mm



DOUBLE END

Asa60  
(stainless steel)  
ø 6.0 mm



Asa Light MV  
(stainless steel, hollow)  
ø 8.0 mm



Leonardo ML  
(stainless steel)  
ø 7.0 mm



Octagonal  
(stainless steel)  
ø 5.5 mm



● Alu60  
(aluminum)  
ø 6.0 mm



● Alu80  
(aluminum, hollow)  
ø 8.0 mm



● Magic Color MC  
(aluminum core and non-slip plastic)  
ø 8.0 / 10.5 mm



How to use

- 1/2 Wedelstaet → pattern + scientific name
- MV1604-02 → Asa Dental code
- Asa Light MV → handle option

AsaLady

- products ergonomically designed for women hands:
- smaller and lighter handles
  - smaller finger holes
  - reduced size
  - code starts with "W" or "SW"

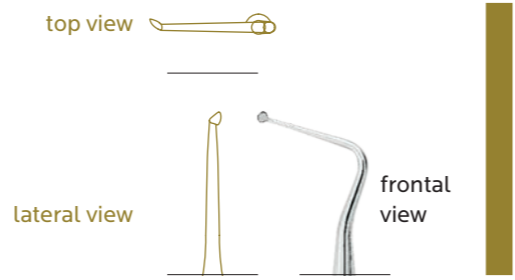
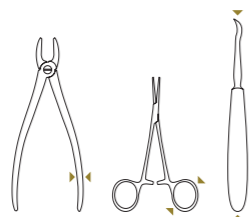

Excavators - spoons

set of 5

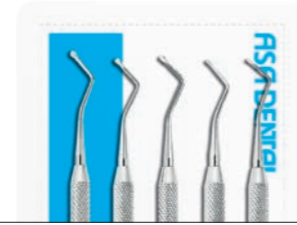

0 · 1 · 2 · 3 · 4  
S1700  
Asa60  
SMV1700  
Asa Light MV

0  
S1700-0  
Asa60

2  
S1700-2  
Asa60

1  
S1700-1  
Asa60

3  
S1700-3  
Asa60

4  
S1700-4  
Asa60

0.8 mm



0  
1700-0  
Asa60  
MV1700-0  
Asa Light MV

1.2 mm

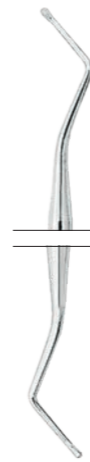

1  
1700-1  
Asa60  
MV1700-1  
Asa Light MV  
MC1700-1  
● Magic Color MC

1.4 mm

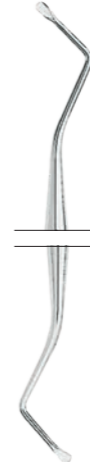

2  
1700-2  
Asa60  
MV1700-2  
Asa Light MV  
MC1700-2  
● Magic Color MC

1.5 mm

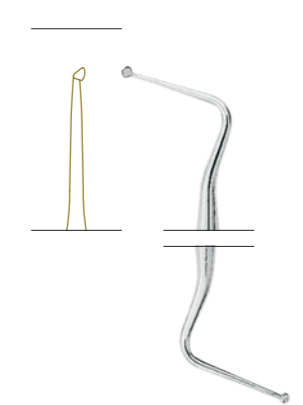

1  
1701-1  
Asa60  
MV1701-1  
Asa Light MV

1.6 mm

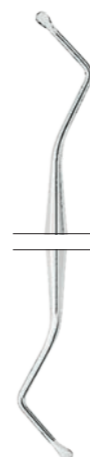

3  
1700-3  
Asa60  
MV1700-3  
Asa Light MV  
MC1700-3  
● Magic Color MC

2 mm



4  
1700-4  
Asa60  
MV1700-4  
Asa Light MV

2 mm

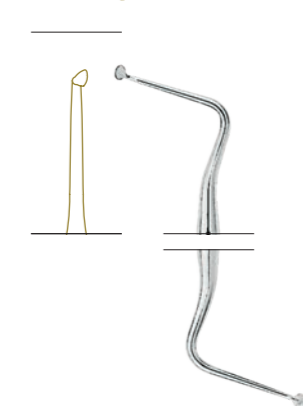

2  
1701-2  
Asa60  
MV1701-2  
Asa Light MV

Excavators - spoons

Excavators - oval spoons

Excavators - ASH

1.2 mm



**6**  
1702-6  
Asa60  
MV1702-6  
Asa Light MV

1.5 mm

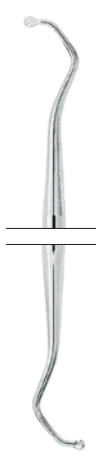

**14**  
1703-14  
Asa60  
MV1703-14  
Asa Light MV  
MC1703-14  
● Magic Color MC

2.2 mm

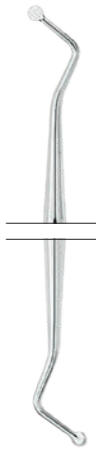

**19**  
1706-19  
Asa60  
MV1706-19  
Asa Light MV

1.2 mm

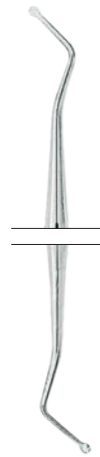

**17**  
1704-17  
Asa60  
MV1704-17  
Asa Light MV  
MC1704-17  
● Magic Color MC

1.2 mm

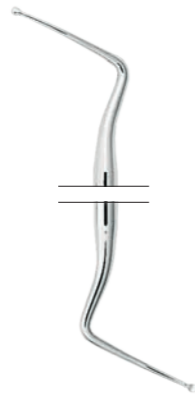

**31L**  
1709-31L  
Asa60  
MV1709-31L  
Asa Light MV

1.5 mm

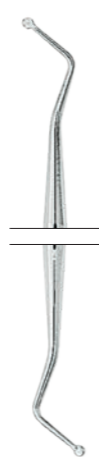

**18**  
1705-18  
Asa60  
MV1705-18  
Asa Light MV

1.5 mm

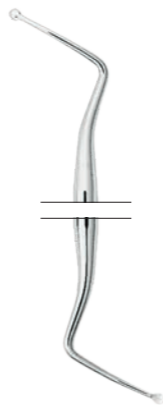

**32L**  
1709-32L  
Asa60  
MV1709-32L  
Asa Light MV

1.2 mm

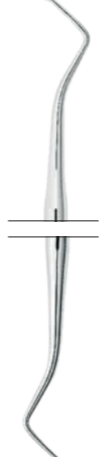

**38/39**  
1707-39  
Asa60  
MV1707-39  
Asa Light MV

2 mm

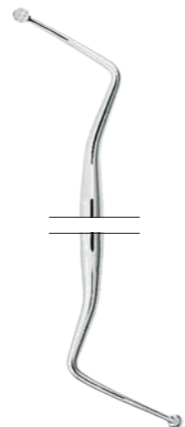

**33L**  
1709-33L  
Asa60  
MV1709-33L  
Asa Light MV

1.2 mm



**17W**  
1704-17W  
Asa60  
MV1704-17W  
Asa Light MV

1.5 mm



**18W**  
1705-18W  
Asa60  
MV1705-18W  
Asa Light MV

2 mm



**19W**  
1706-19W  
Asa60  
MV1706-19W  
Asa Light MV

1 mm



**243**  
1711-243  
Asa60  
ML1711-243  
Leonardo ML

1.4 mm



**G2**  
1711-G2  
Asa60  
ML1711-G2  
Leonardo ML

Excavators - SS. white type

set of 6



5 · 14 · 17 · 18 · 19 · 20  
S1710-6  
Asa60

1 mm



**5**  
1710-5  
Asa60  
ML1710-5  
Leonardo ML

1.2 mm

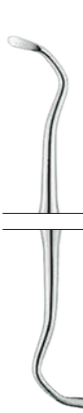

**14**  
1710-14  
Asa60  
ML1710-14  
Leonardo ML

1 mm

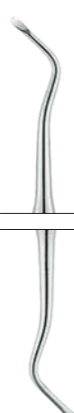

**17**  
1710-17  
Asa60  
ML1710-17  
Leonardo ML

2 mm



**20**  
1710-20  
Asa60  
ML1710-20  
Leonardo ML

1.2 mm

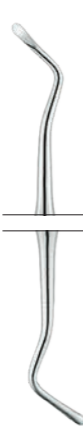

**18**  
1710-18  
Asa60  
ML1710-18  
Leonardo ML

1.6 mm



**19**  
1710-19  
Asa60  
ML1710-19  
Leonardo ML

Excavators - Darby-Perry

0.8 mm



**1 Darby-Perry**  
1711-1  
Asa60  
ML1711-1  
Leonardo ML

0.8 mm

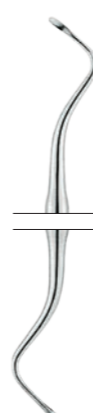

**2 Darby-Perry**  
1711-2  
Asa60  
ML1711-2  
Leonardo ML

1 mm

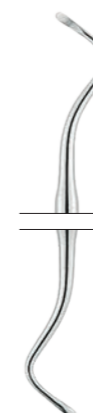

**11 Darby-Perry**  
1711-11  
Asa60  
ML1711-11  
Leonardo ML

1 mm

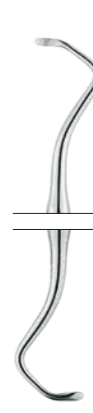

**12 Darby-Perry**  
1711-12  
Asa60  
ML1711-12  
Leonardo ML

1 mm

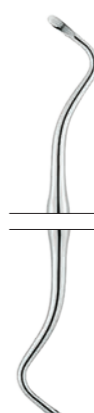

**21 Darby-Perry**  
1711-21  
Asa60  
ML1711-21  
Leonardo ML

2 mm



**42 Darby-Perry**  
1711-42  
Asa60  
ML1711-42  
Leonardo ML

1.2 mm

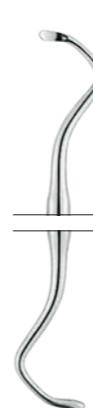

**22 Darby-Perry**  
1711-22  
Asa60  
ML1711-22  
Leonardo ML

1.6 mm

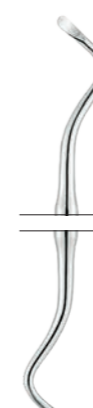

**31 Darby-Perry**  
1711-31  
Asa60  
ML1711-31  
Leonardo ML

1.6 mm

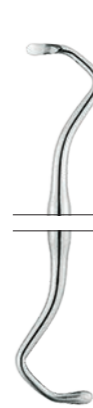

**32 Darby-Perry**  
1711-32  
Asa60  
ML1711-32  
Leonardo ML

2 mm

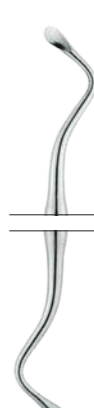

**41 Darby-Perry**  
1711-41  
Asa60  
ML1711-41  
Leonardo ML

Cavity preparation instruments - margin trimmers

Cavity preparation instruments hatchets

Cavity preparation instruments chisels



**1 Black/26**  
distal  
1601-1  
Asa60  
MV1601-1  
Asa Light MV

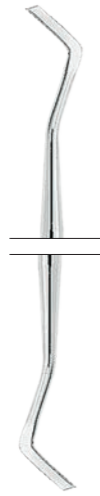

**2 Black/27**  
mesial  
1601-2  
Asa60  
MV1601-2  
Asa Light MV

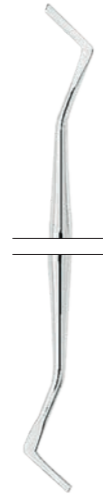

**3 Black/28**  
distal  
1601-3  
Asa60  
MV1601-3  
Asa Light MV

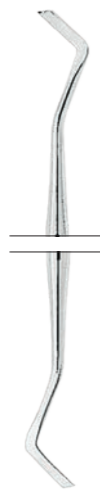

**4 Black/29**  
mesial  
1601-4  
Asa60  
MV1601-4  
Asa Light MV

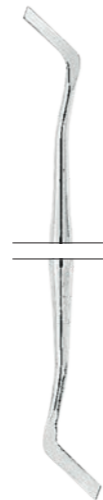

**1 Black/77-78**  
distal  
1602-1  
Asa60  
MV1602-1  
Asa Light MV



**2 Black/79-80**  
mesial  
1602-2  
Asa60  
MV1602-2  
Asa Light MV



**1 Black/53-54**  
1603-1  
Asa60  
MV1603-1  
Asa Light MV



**2 Black/51-52**  
1603-2  
Asa60  
MV1603-2  
Asa Light MV



**1/2 Wedelstaet**  
1604-02  
Asa60  
MV1604-02  
Asa Light MV



**3/4 Wedelstaet**  
1604-04  
Asa60  
MV1604-04  
Asa Light MV



**5/6 Wedelstaet**  
1604-06  
Asa60  
MV1604-06  
Asa Light MV

**Amalgam carriers**

Ø 1.5 mm



medium/small  
20 cm  
1015-1

Ø 2.5 mm

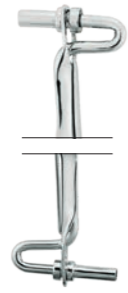

medium/large  
20 cm  
1015-2

Ø 3 mm

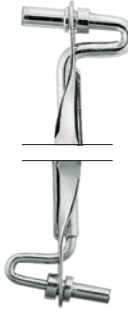

medium/jumbo  
20 cm  
1015-3

Ø 2 mm



small  
15.5 cm  
1011-1

Ø 2 mm



medium  
15.5 cm  
1011-2

Ø 2.5 mm



large  
15.5 cm  
1011-3

Ø 3 mm



jumbo  
15.5 cm  
1011-4

**Amalgam wells**

cold sterilization only



Ø 3.5 cm  
h. 3.5 cm  
1030-1



Ø 2 cm  
h. 4 cm  
1030-2



Ø 2 cm  
h. 2.5 cm  
1030-3

**Amalgam carriers**

Ø 2 mm



straight  
15 cm  
1020-1

Ø 2 mm



45°  
15 cm  
1020-2

Ø 2 mm



90°  
15 cm  
1020-3

Ø 2 mm



metal tip  
for 1020-1-2-3  
1020-2P

Ø 1.2 mm



straight  
for retrograds  
13 cm  
1009-1

Ø 1.2 mm



curved  
for retrograds  
13 cm  
1009-2

Ø 1.8 mm



straight  
for retrograds  
13 cm  
1009-3

Ø 1.8 mm



curved  
for retrograds  
13 cm  
1009-4

autoclavable plastic



15.5 cm  
1021-1  
tip + handle

Ø 2 mm



straight  
1021-1  
tip + handle  
1021-1P  
spare tip  
(10 pcs / bag)

Ø 2 mm



45°  
1021-2  
tip + handle  
1021-2P  
spare tip  
(10 pcs / bag)

Ø 2 mm



90°  
1021-3  
tip + handle  
1021-3P  
spare tip  
(10 pcs / bag)

Cement spatulas

set of 5



- 1 S0903-1
- 2 S0903-2
- 3 S0903-3

glass plate

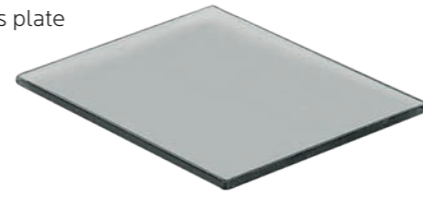

8x12x0.5 cm  
0999-1



Heidemann separating spatulas



Heidemann separating spatulas

set of 5

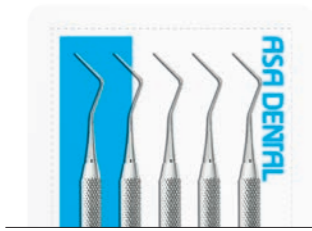

- 1  
S1102-1  
Asa60
- 2  
S1102-2  
Asa60
- 3  
S1102-3  
Asa60

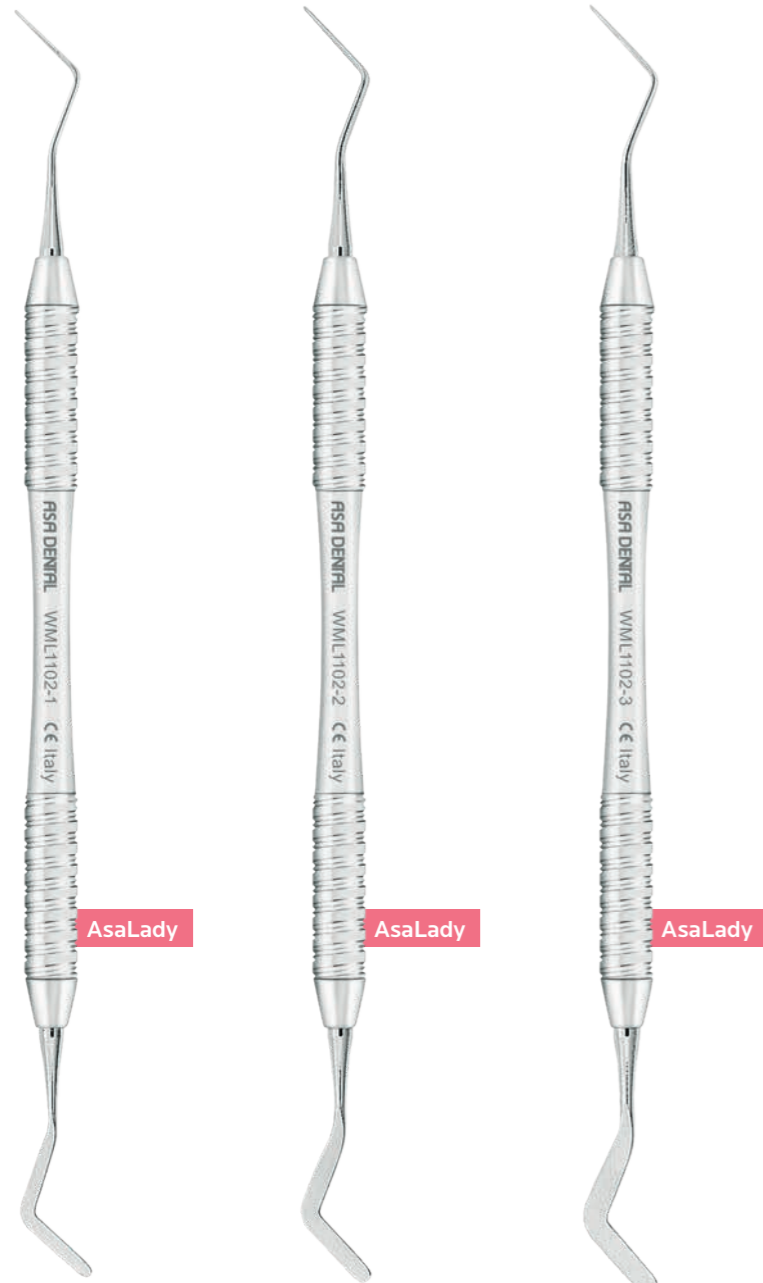

AsaLady

AsaLady

AsaLady

- 1  
1102-1  
Asa60  
MV1102-1  
Asa Light MV  
WML1102-1  
Leonardo ML  
MC1102-1  
● Magic Color MC
- 2  
1102-2  
Asa60  
MV1102-2  
Asa Light MV  
WML1102-2  
Leonardo ML  
MC1102-2  
● Magic Color MC
- 3  
1102-3  
Asa60  
MV1102-3  
Asa Light MV  
WML1102-3  
Leonardo ML

Heidemann separating spatulas

with titanium nitride coating

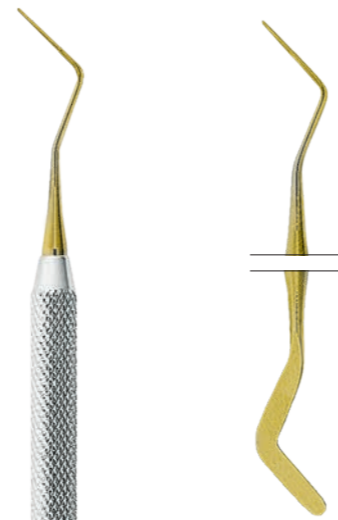

- 3  
1102T-3  
Asa60

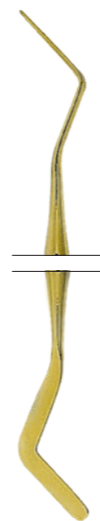

- 1  
1102T-1  
Asa60
- 2  
1102T-2  
Asa60

Filling instruments - amalgam instruments

with titanium nitride coating

set of 5

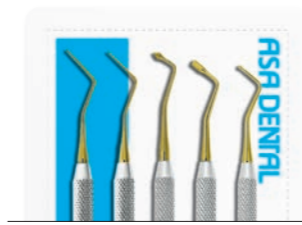

- 1200T-1 · 1202T-2 · 1204T-1
- 1102T-1 · 1102T-2
- S1200T
- Asa60

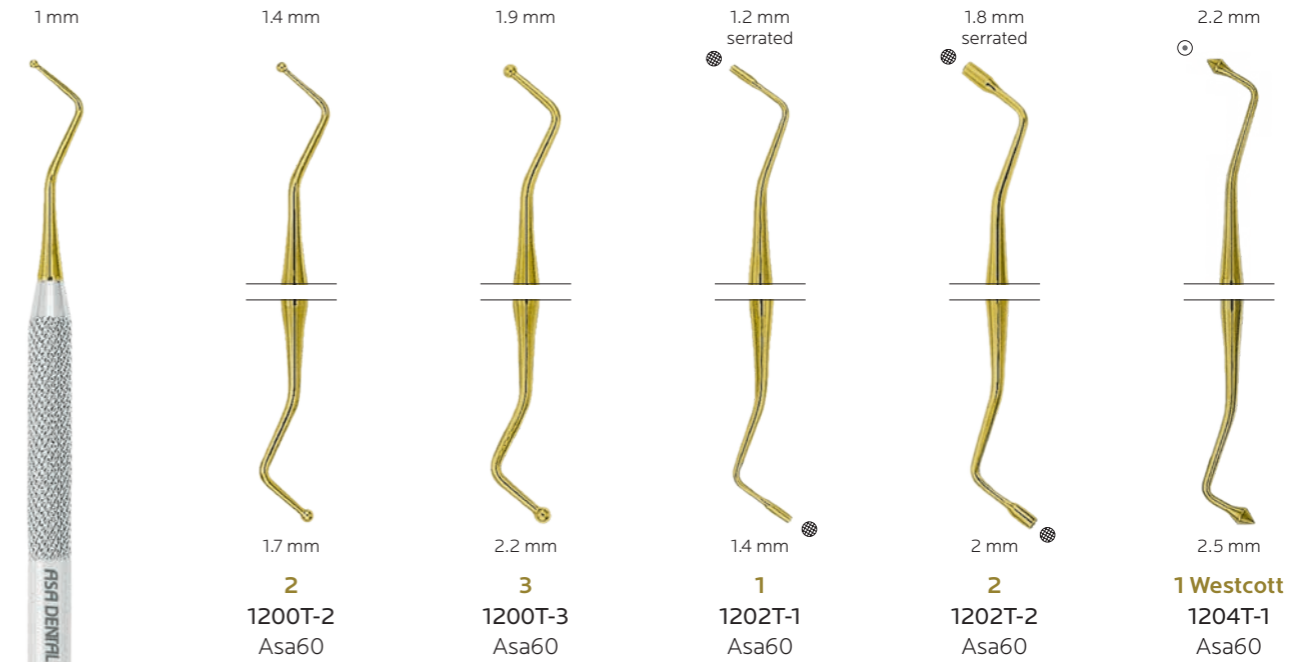

1200T-2

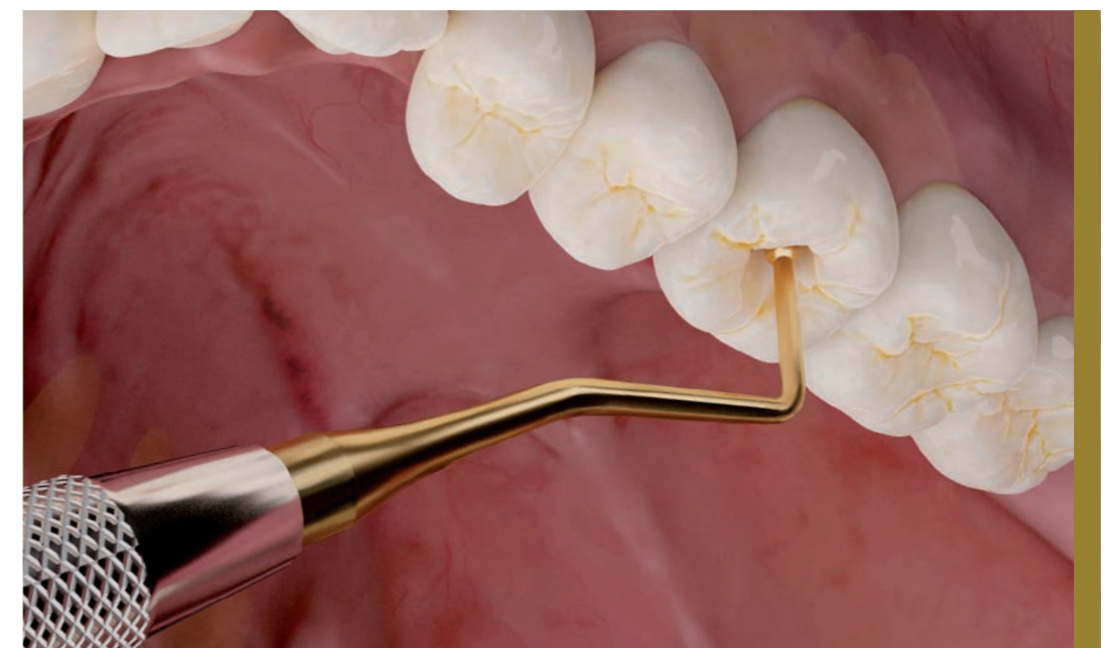

Filling instruments - amalgam instruments

set of 5

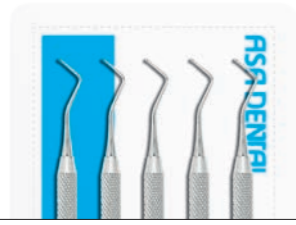

- |                              |                              |
|------------------------------|------------------------------|
| <b>1</b><br>S1200-1<br>Asa60 | <b>3</b><br>S1200-3<br>Asa60 |
| <b>2</b><br>S1200-2<br>Asa60 | <b>4</b><br>S1200-4<br>Asa60 |
|                              | <b>5</b><br>S1200-5<br>Asa60 |

Filling instruments - amalgam instruments

1 mm	1 mm	1.9 mm	1 mm serrated	1.6 mm serrated	2.1 mm serrated	1.2 mm serrated	1.8 mm serrated	2.3 mm serrated	3 mm serrated	1.2 mm non-serrated	1.8 mm non-serrated
1.8 mm	2.2 mm	1 mm	2 mm	2.3 mm	2 mm	2.6 mm	3.2 mm	1.4 mm	2 mm		
<b>2</b> 1200-2 Asa60 MV1200-2 Asa Light MV	<b>3</b> 1200-3 Asa60 MV1200-3 Asa Light MV	<b>1</b> 1201-1 Asa60 MV1201-1 Asa Light MV	<b>2</b> 1201-2 Asa60 MV1201-2 Asa Light MV	<b>3</b> 1201-3 Asa60 MV1201-3 Asa Light MV	<b>2</b> 1202-2 Asa60 MV1202-2 Asa Light MV MC1202-2	<b>3</b> 1202-3 Asa60 MV1202-3 Asa Light MV	<b>4</b> 1202-4 Asa60 MV1202-4 Asa Light MV	<b>1L</b> 1202-1L Asa60 MV1202-1L Asa Light MV	<b>2L</b> 1202-2L Asa60 MV1202-2L Asa Light MV		
	2.5 mm	1.7 mm	1 mm non-serrated	1.6 mm non-serrated	2.1 mm non-serrated		2.3 mm non-serrated	3 mm non-serrated	1 mm	1.4 mm	1.8 mm
1.2 mm	2.9 mm	2.9 mm	1.2 mm	2 mm	2.3 mm	1.4 mm	2.6 mm	3.2 mm	1.2 mm	1.6 mm	2 mm
<b>1</b> 1200-1 Asa60 MV1200-1 Asa Light MV	<b>4</b> 1200-4 Asa60 MV1200-4 Asa Light MV	<b>5</b> 1200-5 Asa60 MV1200-5 Asa Light MV	<b>1L</b> 1201-1L Asa60 MV1201-1L Asa Light MV	<b>2L</b> 1201-2L Asa60 MV1201-2L Asa Light MV	<b>3L</b> 1201-3L Asa60 MV1201-3L Asa Light MV	<b>1</b> 1202-1 Asa60 MV1202-1 Asa Light MV	<b>3L</b> 1202-3L Asa60 MV1202-3L Asa Light MV	<b>4L</b> 1202-4L Asa60 MV1202-4L Asa Light MV	<b>1</b> 1203-1 Asa60 MV1203-1 Asa Light MV	<b>2</b> 1203-2 Asa60 MV1203-2 Asa Light MV	<b>3</b> 1203-3 Asa60 MV1203-3 Asa Light MV

● Magic Color MC

Filling instruments - amalgam instruments

Filling instruments - Markley amalgam instruments





<p>1.5 mm</p>  <p>2 mm</p> <p><b>1 Ward</b> 1205-1 Asa60 MV1205-1 Asa Light MV</p>	<p>2.4 mm</p>  <p>2.8 mm</p> <p><b>2 Ward</b> 1205-2 Asa60 MV1205-2 Asa Light MV</p>	<p>1.4 mm</p>  <p>0.8 mm</p> <p><b>OT Tanner</b> 1211-OT Asa60 MV1211-OT Asa Light MV</p>	<p>2.4 mm</p>  <p>1.4 mm</p> <p><b>1T Tanner</b> 1211-1T Asa60 MV1211-1T Asa Light MV</p>	<p>1.2 mm</p>  <p>0.8 mm</p> <p><b>2T Tanner</b> 1211-2T Asa60 MV1211-2T Asa Light MV</p>	<p>1.8 mm</p>  <p>1.5 mm</p> <p><b>3T Tanner</b> 1211-3T Asa60 MV1211-3T Asa Light MV</p>	<p>1 mm serrated</p>  <p>1.4 mm</p> <p><b>01 Marquette</b> 1212-01 Asa60 MV1212-01 Asa Light MV</p>	<p>1.5 mm</p>  <p>1 mm</p> <p><b>H1 Hollenback</b> 1213-H1 Asa60 MV1213-H1 Asa Light MV</p>	<p>3 mm</p>  <p>2 mm</p> <p><b>H2 Hollenback</b> 1213-H2 Asa60 MV1213-H2 Asa Light MV</p>	<p>2.6 mm</p>  <p>1 mm</p> <p><b>H3 Hollenback</b> 1213-H3 Asa60 MV1213-H3 Asa Light MV</p>	<p>1.8 mm</p>  <p>2.6 mm</p> <p><b>H4 Hollenback</b> 1213-H4 Asa60 MV1213-H4 Asa Light MV</p>
--	---	--	--	--	--	--	--	--	--	--

set of 6

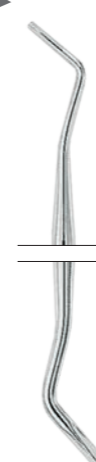

1 · 2 · 3 · 4 · 5 · 6  
S1400  
Asa60

1 · 2 · 3 · 4 · 5 · 6  
SMV1400  
Asa Light MV

<p>0.4 mm</p>  <p>0.6 mm</p> <p><b>1 Markley</b> 1400-1 Asa60 MV1400-1 Asa Light MV</p>	<p>0.5 mm</p>  <p>1 mm</p> <p><b>2 Markley</b> 1400-2 Asa60 MV1400-2 Asa Light MV MC1400-2 ● Magic Color MC</p>	<p>0.4 mm</p>  <p>1.2 mm</p> <p><b>3 Markley</b> 1400-3 Asa60 MV1400-3 Asa Light MV</p>	<p>0.4 mm</p>  <p>1.6 mm</p> <p><b>4 Markley</b> 1400-4 Asa60 MV1400-4 Asa Light MV</p>	<p>0.4 mm</p>  <p>0.5 mm</p> <p><b>5 Markley</b> 1400-5 Asa60 MV1400-5 Asa Light MV</p>	<p>3 mm</p>  <p>1.6 mm</p> <p><b>6 Markley</b> 1400-6 Asa60 MV1400-6 Asa Light MV</p>
---	--	--	--	--	---

Filling instruments - Foc amalgam instruments



This section displays five different Foc amalgam instruments. Each instrument is shown in a full view and a side view. The side views are labeled 'serrated' at the top. The instruments are:

- 0 Foc** (1401-0, Asa60, ML1401-0, Leonardo ML)
- 0S Foc** (1401-0S, Asa60, ML1401-0S, Leonardo ML)
- 1 Foc** (1401-1, Asa60, ML1401-1, Leonardo ML)
- 1S Foc** (1401-1S, Asa60, ML1401-1S, Leonardo ML)
- 2 Foc** (1401-2, Asa60, ML1401-2, Leonardo ML)
- 2S Foc** (1401-2S, Asa60, ML1401-2S, Leonardo ML)

Filling instruments - Burnishers

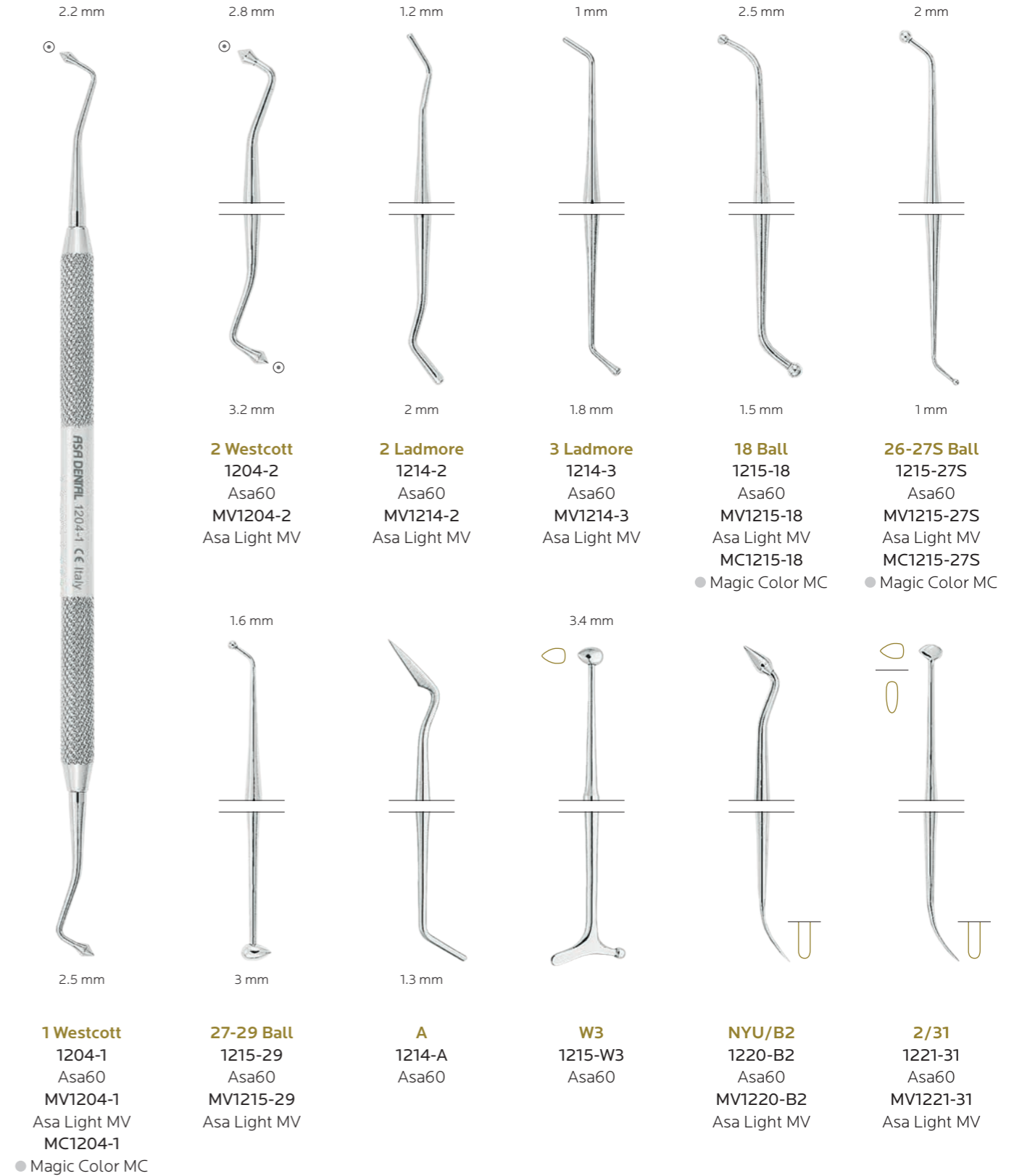

This section displays ten different burnisher instruments. Each instrument is shown in a full view and a side view. The side views are labeled with their respective tip widths. The instruments are:

- 1 Westcott** (1204-1, Asa60, MV1204-1, MC1204-1, Magic Color MC)
- 2 Westcott** (1204-2, Asa60, MV1204-2, Asa Light MV)
- 2 Ladmore** (1214-2, Asa60, MV1214-2, Asa Light MV)
- 27-29 Ball** (1215-29, Asa60, MV1215-29, Asa Light MV)
- A** (1214-A, Asa60)
- 3 Ladmore** (1214-3, Asa60, MV1214-3, Asa Light MV)
- W3** (1215-W3, Asa60)
- 18 Ball** (1215-18, Asa60, MV1215-18, Asa Light MV, MC1215-18, Magic Color MC)
- 26-27S Ball** (1215-27S, Asa60, MV1215-27S, Asa Light MV, MC1215-27S, Magic Color MC)
- NYU/B2** (1220-B2, Asa60, MV1220-B2, Asa Light MV)
- 2/31** (1221-31, Asa60, MV1221-31, Asa Light MV)

Felt composite instruments

set of 6



1 · 2 · 3 · 4 · 5 · 6  
S1220  
● Alu60



1 Felt  
1220-1  
● Alu60

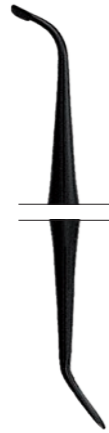

2 Felt  
1220-2  
● Alu60

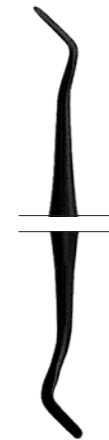

4 Felt  
1220-4  
● Alu60



3 Felt  
1220-3  
● Alu60

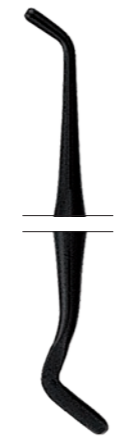

5 Felt  
1220-5  
● Alu60



6 Felt  
1220-6  
● Alu60

Plastic filling instruments

with titanium nitride coating

1 mm



1.2 mm  
1  
1208T-1  
Asa60

1.6 mm



2 mm  
2  
1208T-2  
Asa60

2 mm



2.6 mm  
3  
1208T-3  
Asa60

2 mm



0.1 mm  
2  
1209T-2  
Asa60







2.9 mm

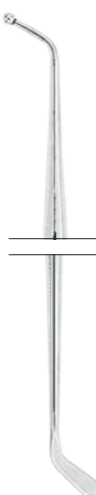
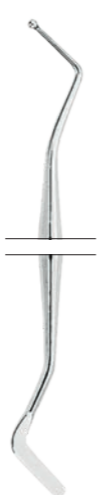

0.4 mm  
2  
1210T-2  
Asa60

Plastic filling instruments

Plastic filling instruments

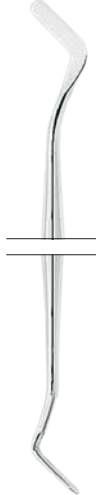
1.2 mm  0.1 mm	1.6 mm  0.1 mm	1.2 mm  2.2 mm	1.6 mm  2.7 mm	1 mm  2 mm	2.5 mm  0.1 mm
<b>1</b> 1206-1 Asa60 MV1206-1 Asa Light MV	<b>2</b> 1206-2 Asa60 MV1206-2 Asa Light MV	<b>1</b> 1207-1 Asa60 MV1207-1 Asa Light MV	<b>2</b> 1207-2 Asa60 MV1207-2 Asa Light MV	<b>1</b> 1208-1 Asa60 MV1208-1 Asa Light MV	<b>3</b> 1209-3 Asa60 MV1209-3 Asa Light MV
0.7 mm  2.5 mm	2.5 mm  3 mm	1 mm  0.1 mm	2 mm  0.1 mm	0.1 mm  0.1 mm	0.1 mm  0.1 mm
<b>1</b> 1208-2 Asa60 MV1208-2 Asa Light MV	<b>3</b> 1208-3 Asa60 MV1208-3 Asa Light MV	<b>1</b> 1209-1 Asa60 MV1209-1 Asa Light MV	<b>2</b> 1209-2 Asa60 MV1209-2 Asa Light MV	<b>1</b> 1210-1 Asa60 MV1210-1 Asa Light MV	<b>2</b> 1210-2 Asa60 MV1210-2 Asa Light MV MC1210-2 ● Magic Color MC

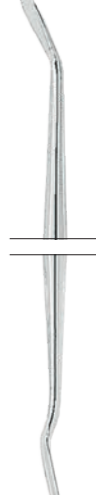
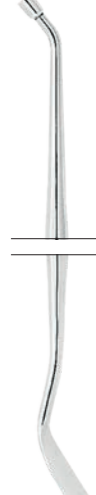
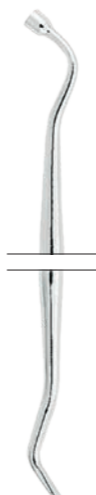
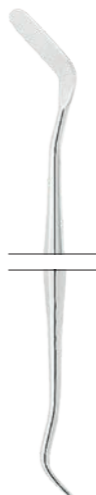
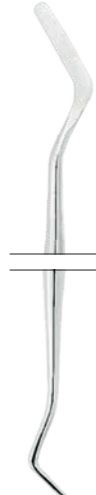
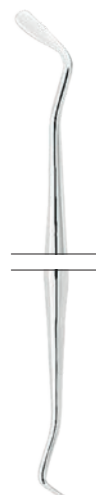
 0.1 mm	 0.1 mm	 0.1 mm
<b>3</b> 1210-3 Asa60 MV1210-3 Asa Light MV	<b>1 Woodson</b> 1216-1 Asa60 MV1216-1 Asa Light MV	<b>2 Woodson</b> 1216-2 Asa60 MV1216-2 Asa Light MV
 0.1 mm	 0.1 mm	 0.1 mm
<b>3 Woodson</b> 1216-3 Asa60 MV1216-3 Asa Light MV	<b>11</b> 1217-11 Asa60 MV1217-11 Asa Light MV	<b>6</b> 1218-6 Asa60 MV1218-6 Asa Light MV
 0.1 mm		
<b>179</b> 1219-179 Asa60 MV1219-179 Asa Light MV		

Amalgam carvers

Amalgam carvers



**1/2 Hollenback**  
1500-02  
Asa60  
MV1500-02  
Asa Light MV  
MC1500-02

● Magic Color MC

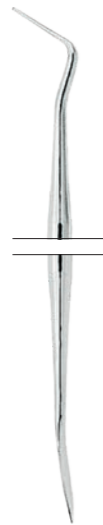

**1 Ward**  
1501-1  
Asa60  
MV1501-1  
Asa Light MV



**2 Ward**  
1501-2  
Asa60  
MV1501-2  
Asa Light MV

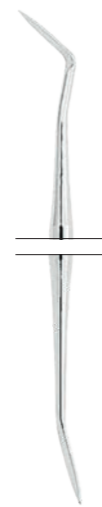

**1S Ward**  
1501-1S  
Asa60  
MV1501-1S  
Asa Light MV

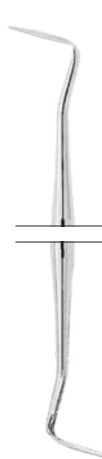

**3 Hollenback**  
1500-3  
Asa60  
MV1500-3  
Asa Light MV



**3S Hollenback**  
1500-3S  
Asa60  
MV1500-3S  
Asa Light MV



**1 Frahm**  
1502-1  
Asa60  
MV1502-1  
Asa Light MV

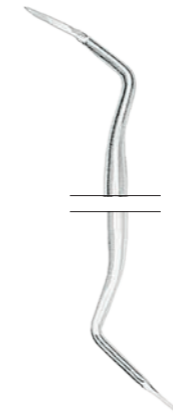

**2 USC**  
1503-2  
Asa60



**SHO-A**  
1505-A  
Asa60

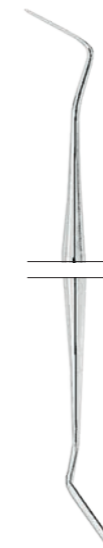

**1 Interproximal**  
1504-1  
Asa60



**3-SHO**  
1505-3  
Asa60

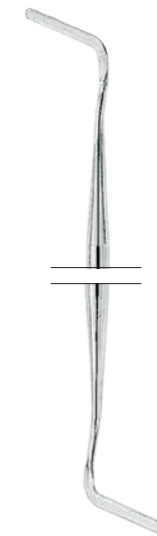

**2 Interproximal off-angle**  
1504-2  
Asa60

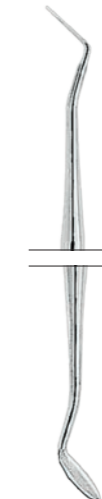

**104**  
1506-104  
Asa60



**8 Wiland**  
1507-8  
Asa60  
MV1507-8  
Asa Light MV

Amalgam carvers



<b>1</b> cleoid-discoïd 1600-1 Asa60 MV1600-1 Asa Light MV MC1600-1	<b>2</b> cleoid-discoïd 1600-2 Asa60 MV1600-2 Asa Light MV	<b>3</b> cleoid-discoïd 1600-3 Asa60 MV1600-3 Asa Light MV	<b>4</b> cleoid-discoïd 1600-4 Asa60 MV1600-4 Asa Light MV
---	---	---	---

● Magic Color MC

instruments for retractor wire



<b>1</b> 1310-1 Asa60	<b>2</b> 1310-2 Asa60
-----------------------------	-----------------------------

Operative instruments

medication  
instrument

placement instruments

gauze packers



**Orban Loop**  
1303  
Octagonal



1300  
Asa35



1301  
Asa60  
MV1301  
Asa Light MV



1302  
Asa60  
MV1302  
Asa Light MV



**1 Luniatschek**  
2 mm  
1355-1  
Octagonal



**2 Luniatschek**  
3 mm  
1355-2  
Octagonal

**Crown instruments**

crown removers  
complete with tips  
double ended

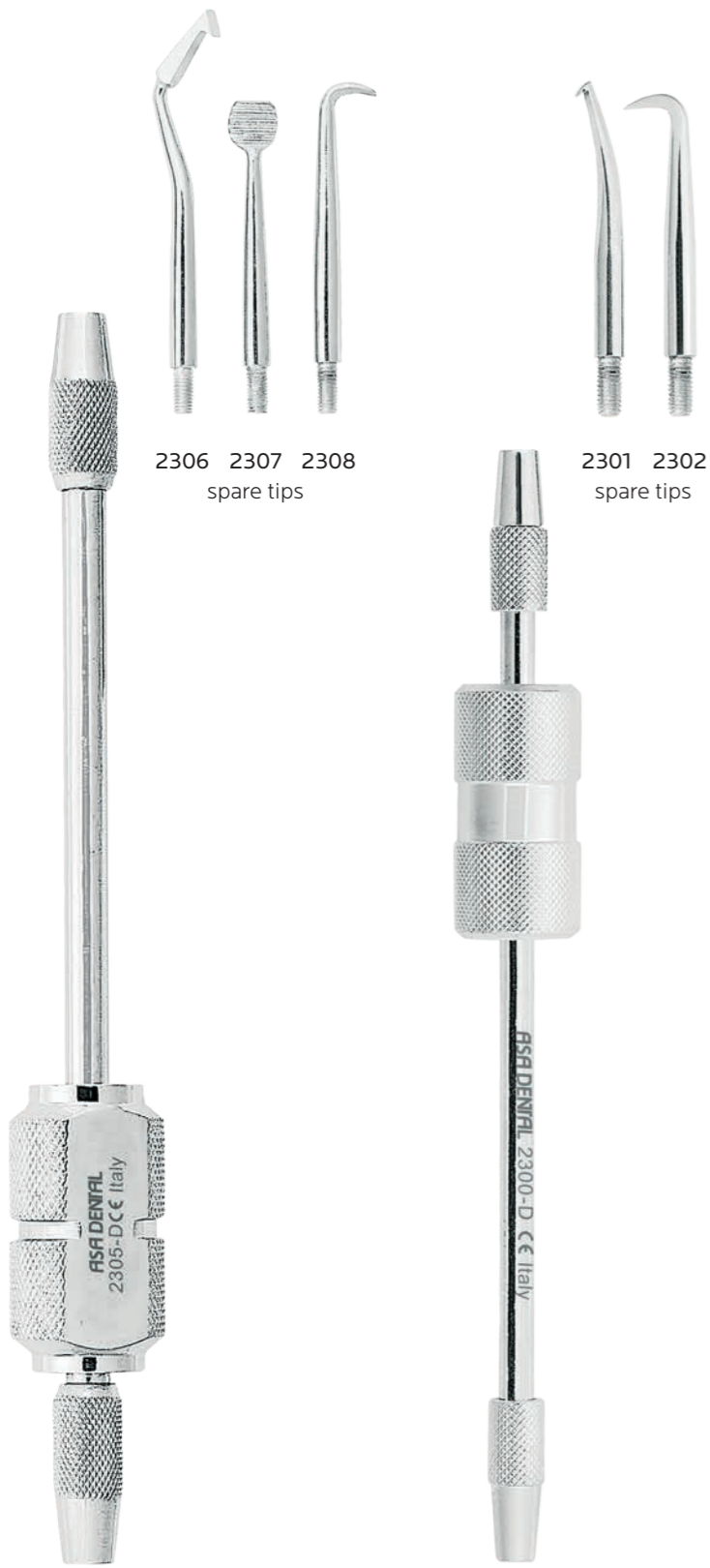

2305-D  
handle + 3 tips

2300-D  
handle + 2 tips

2300-S  
handle + 2 tips

crown remover  
complete with tips  
single ended



2320

**Crown instruments**

crown spreaders



0  
2340-0

1  
2340-1

2  
2340-2

3  
2340-3

**Crown instruments**

decimal calipers

measuring range: 0-10 mm  
(indicative measures)



**Iwanson  
for wax**  
2550-1

measuring range: 0-10 mm  
(indicative measures)



**Iwanson  
for metal**  
2550-2

measuring range: 0-100 mm  
(indicative measures)



**Boley**  
14 cm  
2555

articulating paper forceps



**Miller**  
15 cm  
0670  
15 cm  
0671

**Crown instruments**

telescope crown pliers

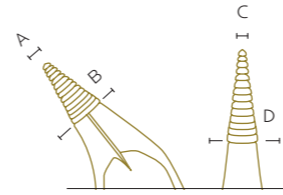

A	4.4 mm
B	5.0 mm
C	3.4 mm
D	3.8 mm

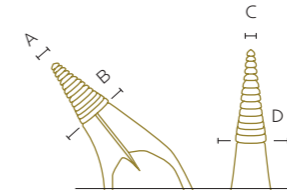

A	3.3 mm
B	4.0 mm
C	2.3 mm
D	3.0 mm



**Böhm**  
14.5 cm  
2500-2



**Böhm**  
11.5 cm  
2500-1

copper rings removing pliers



**Furrer  
straight**  
16 cm  
2331-1



**Furrer  
curved**  
16 cm  
2331-2

Hemostats



1 Halstead-Mosquito  
straight  
12 cm  
0500-1



1 Micro-Mosquito  
straight  
10 cm  
0501-1



1 Kelly  
straight  
14 cm  
0510-1

Scissors

for gold foils



1  
straight  
12 cm  
0300-1

wire scissor  
with tungsten carbide blades



TC Universal  
12 cm  
5700TC

wire scissor  
one blade serrated



Universal  
12 cm  
5700

Crown scissors



1  
straight  
one blade serrated  
10.5 cm  
5600-1



2  
curved  
one blade serrated  
10.5 cm  
5600-2



1  
straight  
10.5 cm  
5601-1



2  
curved  
10.5 cm  
5601-2

Matrix retainers



8 Ivory  
5 mm  
3070-5

8 Ivory  
6 mm  
3070-6

8 Ivory  
7 mm  
3070-7

8N Ivory  
3071



8P Didner  
3072

Tofflemire  
Universal  
3073-1

Tofflemire  
Junior  
3073-2

Tofflemire  
Senior  
3073-3

Matrix

bands

for matrix retainers

- 3070-5
- 3071
- 3072
- 3073-1
- 3073-2
- 3073-3

for matrix retainers

- 3070-6
- 3070-7
- 3071
- 3072
- 3073-1
- 3073-2
- 3073-3

for matrix retainers

- 3070-7
- 3071
- 3072
- 3073-1
- 3073-2
- 3073-3



5 mm x 100 cm  
3082-5



6 mm x 100 cm  
3082-6



7 mm x 100 cm  
3082-7

Tofflemire

12 pcs / pack



1  
Tofflemire  
3081-1



2  
Tofflemire  
3081-2



3  
Tofflemire  
3081-3

12 pcs / pack

assorted:  
3081-1  
3081-2  
3081-3



Tofflemire  
3081

**Composite instruments**

Molars and Pre-molars

Molars, Pre-molars, Incisors and Canines

**Composite instruments**

Molars, Pre-molars, Incisors and Canines

Molars and Pre-molars



**Asa Com 1/1B**  
5112-3  
Asa60

**Asa Com 2/2B**  
0704-16D2  
Asa60

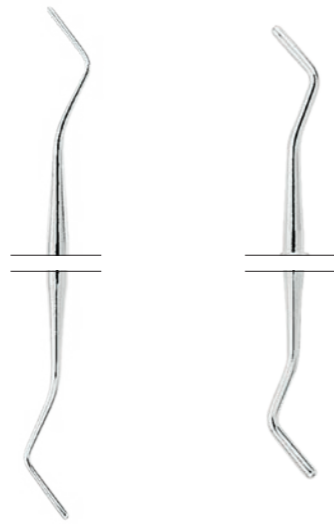

**Asa Com 3/3B**  
1203-1  
Asa60

**Asa Com 4/4B**  
1203-3  
Asa60

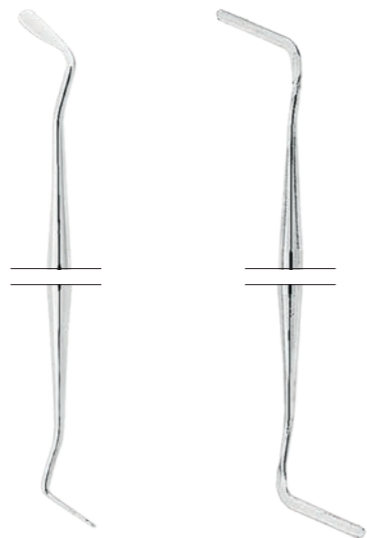

**Asa Com 5/5B**  
1219-179  
Asa60

**Asa Com 6/6B**  
1504-2  
Asa60

**Asa Com 1/1B**

small and large tips ideal for filling and modeling occlusal anatomy in posterior areas  
Universal

**Asa Com 2/2B**

same tips with different angle to model occlusal sulcus in hard to reach posterior areas  
Universal

**Asa Com 3/3B**

highly versatile condenser with small and large semi-spherical tip, for placement and contouring  
valid for: class 1, 2, 3, 4 and 5

**Asa Com 4/4B**

highly versatile condenser with small and large semi-spherical tip, for placement and contouring  
valid for: class 1, 2, 3, 4 and 5

**Asa Com 5/5B**

versatile instrument for application, layering and modeling of composite, with opposite (lateral and frontal) blades  
valid for: class 1, 2, 3, 4 and 5

**Asa Com 6/6B**

filling and shaping instrument, ideal for composite definition in mesial and distal areas  
valid for: class 2, 3 and 5



**Asa Com 7/7B**  
5153-1  
● Alu80



**Asa Com 8/8B**  
1220-B2  
Asa60

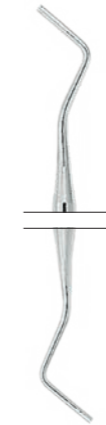

**Asa Com 9/9B**  
1201-1L  
Asa60

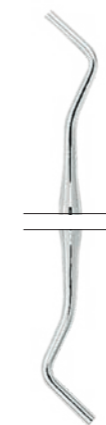

**Asa Com 10/10B**  
1201-2L  
Asa60

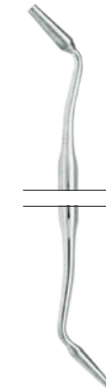

**Asa Com 11/11B**  
1401-1  
Asa60

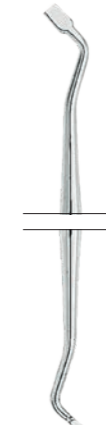

**Asa Com 12/12B**  
1213-H3  
Asa60

**Asa Com 7/7B**

versatile instrument ideal for gingival areas but also suitable for medial and distal definition  
valid for: class 1, 2, 3, 4 and 5

**Asa Com 8/8B**

combination of small tip for occlusal anatomy modeling and narrow paddle for labial areas  
Universal

**Asa Com 9/9B**

small and large, flat tip condenser  
valid for: class 1, 2, 3, 4 and 5

**Asa Com 10/10B**

small and large, flat tip condenser  
valid for: class 1, 2, 3, 4 and 5

**Asa Com 11/11B**

small and large tip condenser  
Universal

**Asa Com 12/12B**

versatile condenser with opposite (lateral and frontal) tips  
Universal

**Composite instruments**

Molars, Pre-molars, Incisors and Canines

Magic Color MC composite instruments

**Composite instruments**



**Asa Com 13/13B** 5112-4 Asa60  
**Asa Com 15/15B** 1210-3 Asa60

**Asa Com 13/13B**  
 opposing blades instrument  
 for composite contouring,  
 removal and modeling  
 Universal

**Asa Com 14/14B**  
 versatile instrument  
 composite application,  
 layering and modeling,  
 with opposite (lateral and  
 frontal) tips  
 Universal

**Asa Com 15/15B**  
 versatile instrument  
 composite application,  
 layering and modeling,  
 with opposite (lateral and  
 frontal) tips  
 valid for: class 2, 3, 4 and 5

**Asa Com 14/14B**  
 1210-1  
 Asa60



**MC1510-1D** ● Magic Color MC  
**MC1510-2D** ● Magic Color MC  
**MC1510-3D** ● Magic Color MC  
**MC1510-4D** ● Magic Color MC  
**MC1510-5D** ○ Magic Color MC

**MC1510-2D** ● Magic Color MC  
**MC1510-3D** ● Magic Color MC



S1222-7

Asa Com 1/1B	5112-3
Asa Com 2/2B	0704-16D2
Asa Com 3/3B	1203-1
Asa Com 4/4B	1203-3
Asa Com 5/5B	1219-179
Asa Com 6/6B	1504-2
Asa Com 7/7B	5153-1

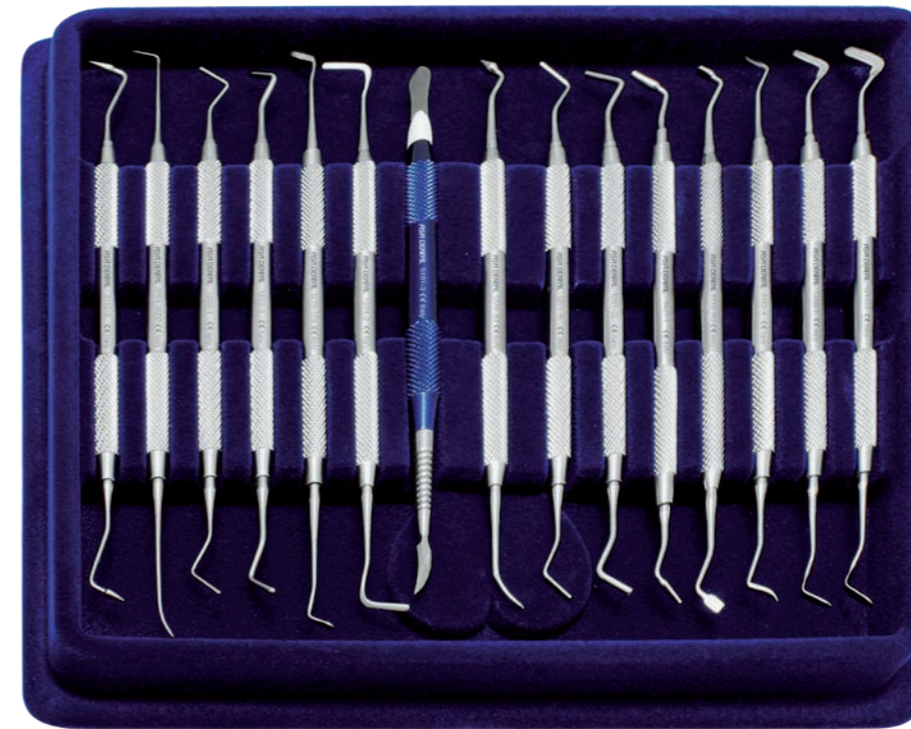

S1222-15

Asa Com 1/1B	5112-3
Asa Com 2/2B	0704-16D2
Asa Com 3/3B	1203-1
Asa Com 4/4B	1203-3
Asa Com 5/5B	1219-179
Asa Com 6/6B	1504-2
Asa Com 7/7B	5153-1
Asa Com 8/8B	1220-B2
Asa Com 9/9B	1201-1L
Asa Com 10/10B	1201-2L
Asa Com 11/11B	1401-1
Asa Com 12/12B	1213-H3
Asa Com 13/13B	5112-4
Asa Com 14/14B	1210-1
Asa Com 15/15B	1210-3



# PERIODONTAL

MADE IN ITALY

## THE CUTTING EDGE

At Asa Dental we know that every professional cares the most about two things: clients' satisfaction and time. Hence, manufacturing instruments that guarantee the best results in the shortest time have become our number one motivator. We use cutting edge technologies to obtain cutting edge periodontal instruments, and we explore any possible design to give them the necessary shape, handle and size options. Sharp, durable and resilient to resist time and use.

- G3 Pocket Probes
- G4 Curettes and Scalers
- G11 Gracey curettes
- G14 Scalers
- G16 Periosteals and Elevators
- G20 Bone curettes
- G22 Files
- G24 Gingivectomy knives
- G26 Chisels and Gouges
- G29 Mallets
- G30 Accessories
- G31 Pocket markers
- G32 Grinding stones
- G34 Kits

### Handle options

#### SINGLE END

Asa35  
(stainless steel)  
ø 3.5 mm

Asa60  
(stainless steel)  
ø 6.0 mm

Leonardo ML  
(stainless steel)  
ø 7.0 mm

● Magic Color MC  
(aluminum core and  
non-slip plastic)  
ø 8.0 / 10.5 mm

#### DOUBLE END

Asa60  
(stainless steel)  
ø 6.0 mm

Asa Light MV  
(stainless steel, hollow)  
ø 8.0 mm

Leonardo ML  
(stainless steel)  
ø 7.0 mm

Leonardo Light LV  
(stainless steel)  
ø 10.0 mm

Octagonal  
(stainless steel)  
ø 5.5 mm

Perfection  
(stainless steel)  
ø 8.0 mm

● Magic Color MC  
(aluminum core and  
non-slip plastic)  
ø 8.0 / 10.5 mm

#### How to use

- CP-12 → pattern + scientific name
- MC0702-12 → Asa Dental code
- Magic Color MC → handle option

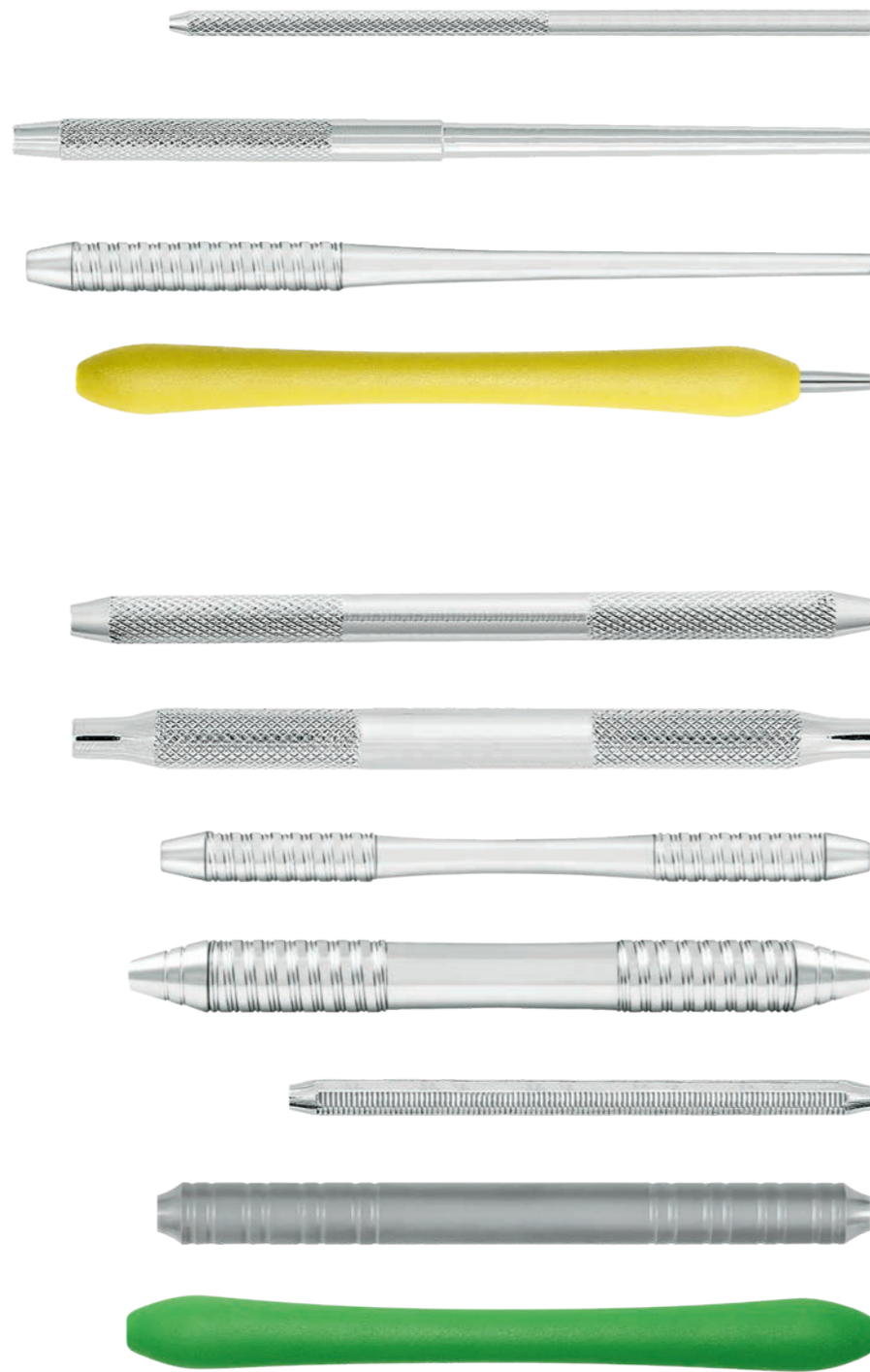

### Periodontal pocket Probes



Easy and fast to clean, they guarantee maximum precision. Depth markings resist to the most stressing conditions, including temperature and chemicals, to maintain performance over time and use. The ergonomic handle is designed to transform the instrument in the natural extension of your hand.

- New marking process
- Laser system marking
- No more paint peeling off
- Permanent marking
- Antiglare, low depth marking
- Maximum tip resistance against breaking

	3 6 8 11	3 6 9 12	3.5 5.5 8.5 11.5	4 5 9 10 14 15
	<b>CP-11</b> 0702L-11 Asa60	<b>CP-12</b> 0702L-12 Asa60 ● Magic Color MC	<b>CP-12S</b> 0702L-12S Asa60	<b>CP-15</b> 0702L-15 Asa60
	1 2 3 5 7 8 9 10	1 2 3 5 7 8 9 10	1 2 3 5 7 8 9 10	1 2 3 5 7 8 9 10 FLAT TIP
	<b>Williams</b> 0703L-1 Asa60	<b>Merrit A</b> 0703L-2 Asa60	<b>Merrit B</b> 0703L-3 Asa60	<b>Goldman-Fox</b> 0703L-4 Asa60
	3 6 8	1 2 3 5 7 8 9 10	3.5 6 9 12	1 2 3 5 7 8 9 10 12 14
<b>CP-C</b> 0702-C Asa35	<b>University of Michigan</b> 0703L-5 Asa60	<b>26 G</b> 0703L-6 Asa60	<b>OMS Novatech</b> ML0702-OMS Leonardo ML MC0702-OMS ● Magic Color MC	<b>Williams</b> ML0703-14 Leonardo ML MC0703-14 ● Magic Color MC

Curettes and Scalers

set of 7



02 · 2RL · 4RL · 14 · 412 · 414 · Z  
S1806  
Asa60  
02 · 2RL · 4RL · 14 · 412 · 414 · Z  
SMV1806  
Asa Light MV



**HU 1/2**  
1806-02  
Asa60  
MV1806-02  
Asa Light MV

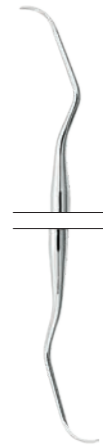

**2R/2L Columbia**  
1806-2RL  
Asa60  
MV1806-2RL  
Asa Light MV  
ML1806-2RL  
Leonardo ML  
MC1806-2RL  
● Magic Color MC



**411/412 Columbia**  
1806-412  
Asa60  
MV1806-412  
Asa Light MV

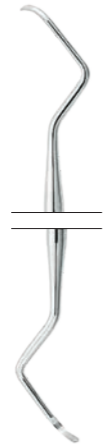

**4R/4L Columbia**  
1806-4RL  
Asa60  
MV1806-4RL  
Asa Light MV  
ML1806-4RL  
Leonardo ML  
MC1806-4RL  
● Magic Color MC

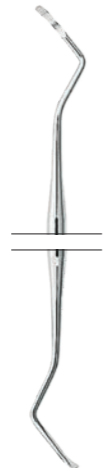

**413/414 Columbia**  
1806-414  
Asa60  
MV1806-414  
Asa Light MV

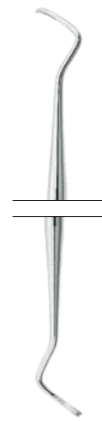

**13/14 Columbia**  
1806-14  
Asa60  
MV1806-14  
Asa Light MV  
ML1806-14  
Leonardo ML  
MC1806-14  
● Magic Color MC



**Zerfing-Chisel**  
1820-Z  
Asa60



**HU 1/2 Langer**  
1805-02  
Asa60  
MV1805-02  
Asa Light MV

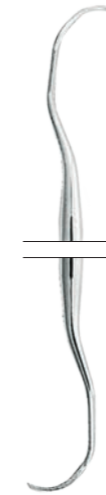

**3/4 Langer**  
1805-04  
Asa60  
MV1805-04  
Asa Light MV



**5/6 Barnhart**  
1821-06  
Asa60

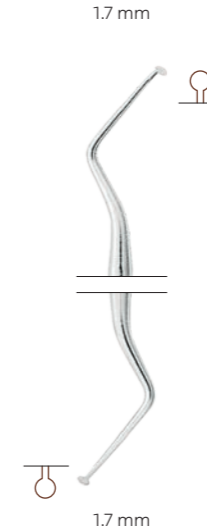

**1 De Marco**  
1808-1  
Asa60



**13/14 Indiana University anterior**  
1824-14  
Asa60  
MV1824-14  
Asa Light MV

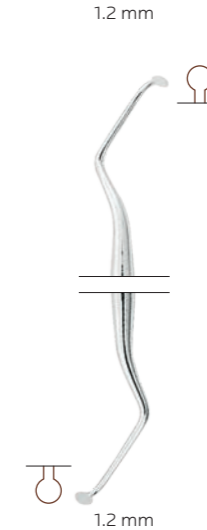

**2 De Marco**  
1808-2  
Asa60

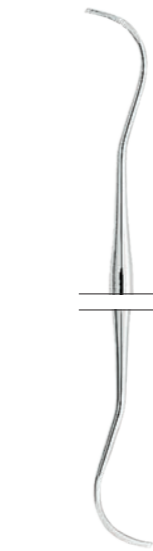

**17/18 Indiana University posterior**  
1824-18  
Asa60  
MV1824-18  
Asa Light MV

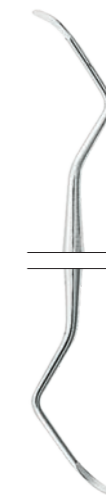

**1/2 Barnhart**  
1821-02  
Asa60



**ME-1 (10/11)**  
1822-ME1  
Asa60



**3/4 Rule (23/24)**  
1823-R04  
Asa60

Curettes and Scalers

set of 7



1 · 2 · 3 · 4 · 5 · 6 · 21

S1809

Asa60

1 · 2 · 3 · 4 · 5 · 6 · 21

SMV1809

Asa Light MV



**1 Goldman-Fox**  
1809-1  
Asa60  
MV1809-1  
Asa Light MV  
ML1809-1  
Leonardo ML

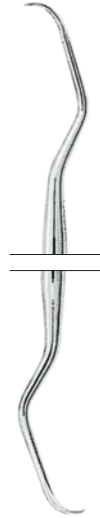

**2 Goldman-Fox**  
1809-2  
Asa60  
MV1809-2  
Asa Light MV  
ML1809-2  
Leonardo ML

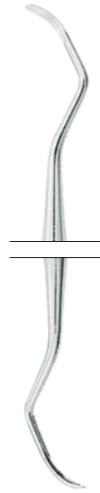

**3 Goldman-Fox**  
1809-3  
Asa60  
MV1809-3  
Asa Light MV  
ML1809-3  
Leonardo ML

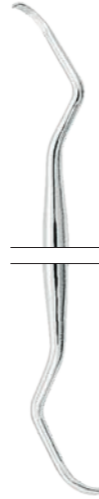

**4 Goldman-Fox**  
1809-4  
Asa60  
MV1809-4  
Asa Light MV  
ML1809-4  
Leonardo ML

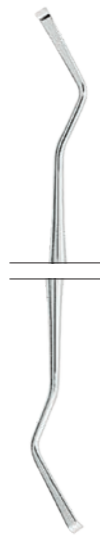

**5 Goldman-Fox**  
1809-5  
Asa60  
MV1809-5  
Asa Light MV  
ML1809-5  
Leonardo ML

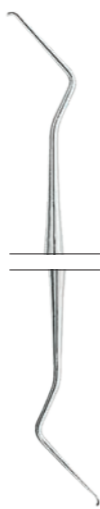

**6 Goldman-Fox**  
1809-6  
Asa60  
MV1809-6  
Asa Light MV

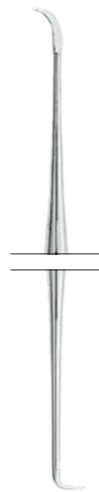

**21 Goldman-Fox**  
1809-21  
Asa60  
MV1809-21  
Asa Light MV  
ML1809-21  
Leonardo ML

Curettes and Scalers



**11/12 Mc Call**  
1825-12  
Asa60  
MV1825-12  
Asa Light MV

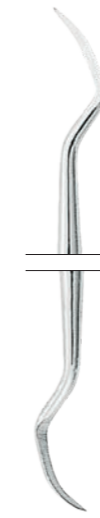

**11A/12A Mc Call**  
1825-12A  
Asa60

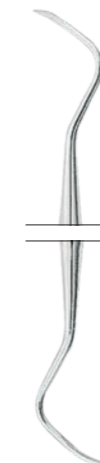

**13S/14S Mc Call**  
1825-14S  
Asa60  
MV1825-14S  
Asa Light MV  
ML1825-14S  
Leonardo ML



**13/14 Mc Call**  
1825-14  
Asa60  
MV1825-14  
Asa Light MV



**17S/18S Mc Call**  
1825-18S  
Asa60  
MV1825-18S  
Asa Light MV



**19/20 Mc Call**  
1825-20  
Asa60  
MV1825-20  
Asa Light MV

Curettes and Scalers



**2/3 Taylor**  
1826-T03  
Asa60  
MV1826-T03  
Asa Light MV  
ML1826-T03  
Leonardo ML  
LV1826-T03  
Leonardo Light LV

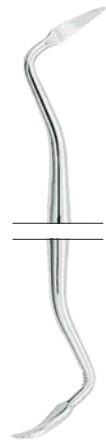

**204**  
1827-204  
Asa60

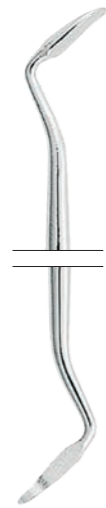

**6 Crane-Kaplan**  
1829-CK6  
Asa60  
MV1829-CK6  
Asa Light MV  
ML1829-CK6  
Leonardo ML  
LV1829-CK6  
Leonardo Light LV

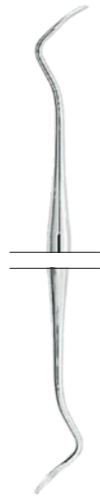

**204S**  
1827-204S  
Asa60  
MV1827-204S  
Asa Light MV  
ML1827-204S  
Leonardo ML  
LV1827-204S  
Leonardo Light LV  
MC1827-204S  
● Magic Color MC

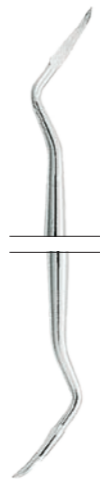

**6S Mini Crane-Kaplan**  
1829-CK6S  
Asa60  
ML1829-CK6S  
Leonardo ML  
MC1829-CK6S  
● Magic Color MC



**31/32 Jacquette**  
1831-32  
Asa60  
MV1831-32  
Asa Light MV

Curettes and Scalers

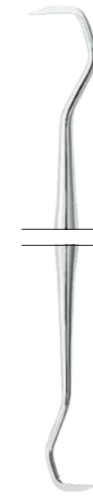

**30/33 Jacquette**  
1831-33  
Asa60  
MV1831-33  
Asa Light MV



**34/35 Jacquette**  
1831-35  
Asa60  
MV1831-35  
Asa Light MV

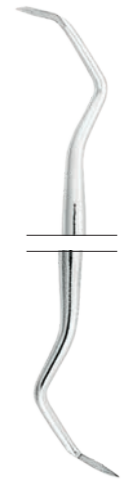

**37/38 Jacquette**  
1831-38  
Asa60  
MV1831-38  
Asa Light MV

1831-32



### Gracey application chart

- Anterior sextants of teeth
  - GRA 1/2** Incisors and Canines
  - GRA 3/4** Incisors and Canines
  - GRA 5/6** Anterior and Premolars
- Buccal and lingual surfaces of posterior teeth
  - GRA 7/8** Premolars and Molars
  - GRA 9/10** Premolars and Molars
- Mesial surfaces of posterior teeth
  - GRA 11/12** Premolars and Molars
  - GRA 15/16** Premolars and Molars
- Distal surfaces of posterior teeth
  - GRA 13/14** Molars
  - GRA 17/18** Molars

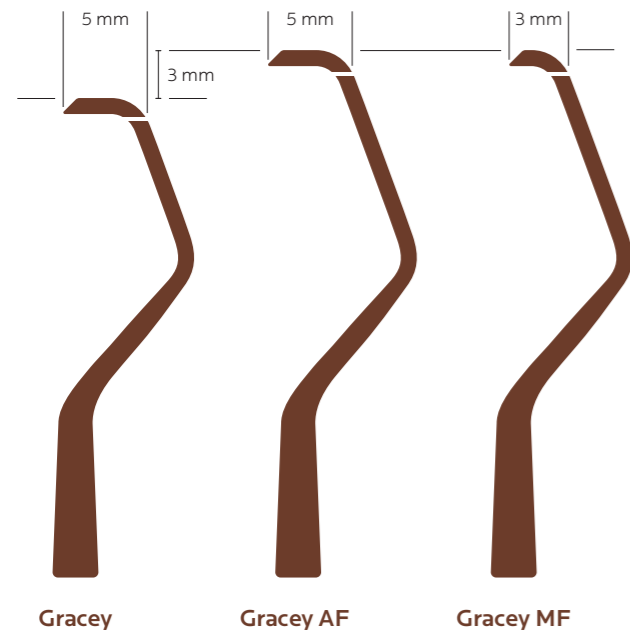
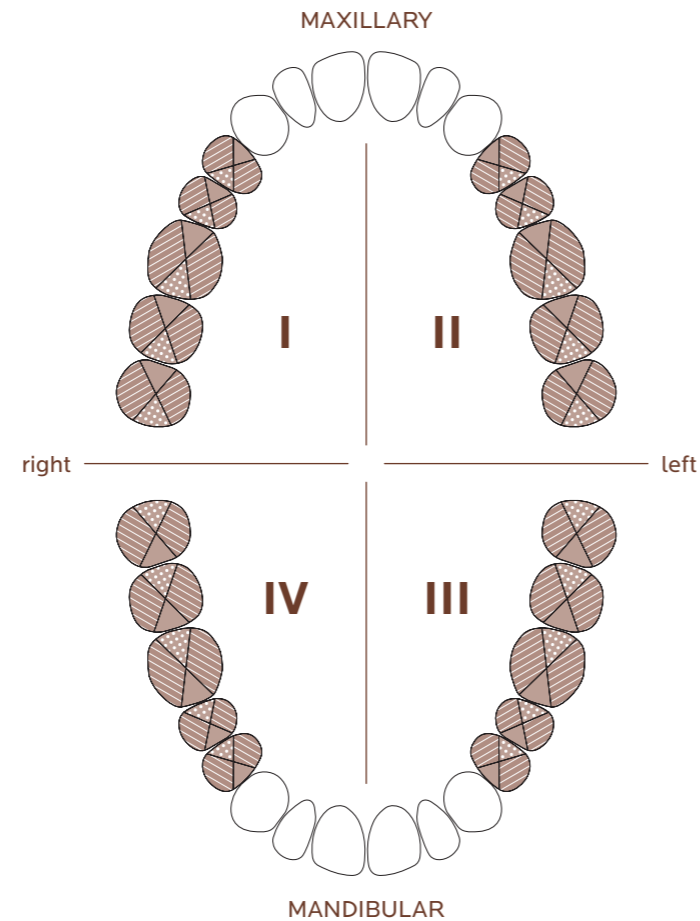

- Magic Color handles
- GRA 1/2
  - GRA 3/4
  - GRA 5/6
  - GRA 7/8
  - GRA 9/10
  - GRA 11/12
  - GRA 13/14
  - GRA 15/16
  - GRA 17/18

### Gracey curettes

	<b>3/4 Gracey</b> 1807-04 Asa60 MV1807-04 Asa Light MV ML1807-04 Leonardo ML LV1807-04 Leonardo Light LV MC1807-04 ● Magic Color MC	<b>5/6 Gracey</b> 1807-06 Asa60 MV1807-06 Asa Light MV ML1807-06 Leonardo ML LV1807-06 Leonardo Light LV MC1807-06 ● Magic Color MC	<b>7/8 Gracey</b> 1807-08 Asa60 MV1807-08 Asa Light MV ML1807-08 Leonardo ML LV1807-08 Leonardo Light LV MC1807-08 ● Magic Color MC	<b>9/10 Gracey</b> 1807-10 Asa60 MV1807-10 Asa Light MV ML1807-10 Leonardo ML LV1807-10 Leonardo Light LV MC1807-10 ● Magic Color MC	<b>11/12 Gracey</b> 1807-12 Asa60 MV1807-12 Asa Light MV ML1807-12 Leonardo ML LV1807-12 Leonardo Light LV MC1807-12 ● Magic Color MC
<b>1/2 Gracey</b> 1807-02 Asa60 MV1807-02 Asa Light MV ML1807-02 Leonardo ML LV1807-02 Leonardo Light LV MC1807-02 ● Magic Color MC	<b>13/14 Gracey</b> 1807-14 Asa60 MV1807-14 Asa Light MV ML1807-14 Leonardo ML LV1807-14 Leonardo Light LV MC1807-14 ● Magic Color MC	<b>15/16 Gracey</b> 1807-16 Asa60 ML1807-16 Leonardo ML LV1807-16 Leonardo Light LV MC1807-16 ● Magic Color MC	<b>17/18 Gracey</b> 1807-18 Asa60 ML1807-18 Leonardo ML LV1807-18 Leonardo Light LV MC1807-18 ● Magic Color MC	<b>11/14 Gracey Mesial-Distal</b> 1807-11MD Asa60 MV1807-11MD Asa Light MV ML1807-11MD Leonardo ML LV1807-11MD Leonardo Light LV	<b>12/13 Gracey Mesial-Distal</b> 1807-13MD Asa60 MV1807-13MD Asa Light MV ML1807-13MD Leonardo ML LV1807-13MD Leonardo Light LV

Gracey curettes - AF

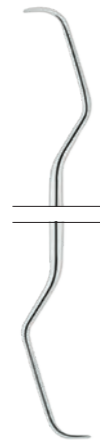

**3/4 Gracey**  
1807-04AF  
Asa60  
ML1807-04AF  
Leonardo ML  
LV1807-04AF  
Leonardo Light LV

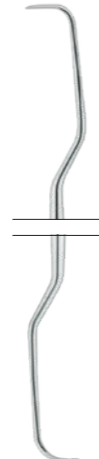

**5/6 Gracey**  
1807-06AF  
Asa60  
ML1807-06AF  
Leonardo ML  
LV1807-06AF  
Leonardo Light LV

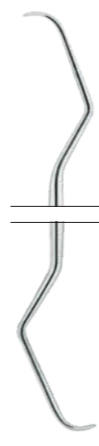

**7/8 Gracey**  
1807-08AF  
Asa60  
ML1807-08AF  
Leonardo ML  
LV1807-08AF  
Leonardo Light LV

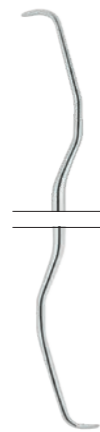

**1/2 Gracey**  
1807-02AF  
Asa60  
ML1807-02AF  
Leonardo ML  
LV1807-02AF  
Leonardo Light LV



**11/12 Gracey**  
1807-12AF  
Asa60  
ML1807-12AF  
Leonardo ML  
LV1807-12AF  
Leonardo Light LV



**13/14 Gracey**  
1807-14AF  
Asa60  
ML1807-14AF  
Leonardo ML  
LV1807-14AF  
Leonardo Light LV

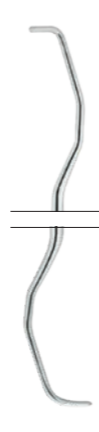

**15/16 Gracey**  
1807-16AF  
Asa60  
ML1807-16AF  
Leonardo ML  
LV1807-16AF  
Leonardo Light LV

Gracey curettes - MF



**3/4 Gracey**  
1807-04MF  
Asa60  
ML1807-04MF  
Leonardo ML  
LV1807-04MF  
Leonardo Light LV  
MC1807-04MF  
● Magic Color MC



**5/6 Gracey**  
1807-06MF  
Asa60  
ML1807-06MF  
Leonardo ML  
LV1807-06MF  
Leonardo Light LV  
MC1807-06MF  
● Magic Color MC

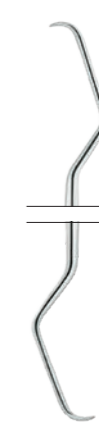

**7/8 Gracey**  
1807-08MF  
Asa60  
ML1807-08MF  
Leonardo ML  
LV1807-08MF  
Leonardo Light LV  
MC1807-08MF  
● Magic Color MC



**1/2 Gracey**  
1807-02MF  
Asa60  
ML1807-02MF  
Leonardo ML  
LV1807-02MF  
Leonardo Light LV  
MC1807-02MF  
● Magic Color MC



**11/12 Gracey**  
1807-12MF  
Asa60  
ML1807-12MF  
Leonardo ML  
LV1807-12MF  
Leonardo Light LV  
MC1807-12MF  
● Magic Color MC



**13/14 Gracey**  
1807-14MF  
Asa60  
ML1807-14MF  
Leonardo ML  
LV1807-14MF  
Leonardo Light LV  
MC1807-14MF  
● Magic Color MC



**15/16 Gracey**  
1807-16MF  
Asa60  
ML1807-16MF  
Leonardo ML  
LV1807-16MF  
Leonardo Light LV  
MC1807-16MF  
● Magic Color MC

Scalers

Scalers



**U15 Towner**  
1903  
Asa60  
ML1903  
Leonardo ML

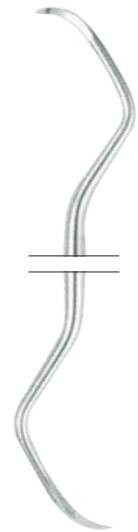

**M23**  
**Universal Scaler**  
1900-M23  
Asa60  
ML1900-M23  
Leonardo ML



**H5/33**  
1904-H5  
Asa60  
MV1904-H5  
Asa Light MV

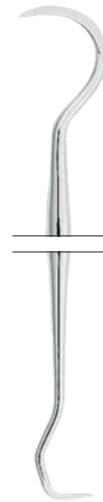

**U15/33**  
**Towner Jacquette**  
1902-1  
Asa60  
MV1902-1  
Asa Light MV  
ML1902-1  
Leonardo ML  
MC1902-1  
● Magic Color MC



**H6/H7**  
1904-H6  
Asa60  
MV1904-H6  
Asa Light MV

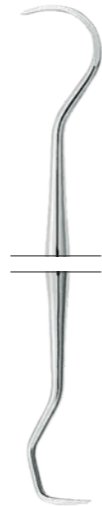

**U15/30**  
**Towner Jacquette**  
1902-2  
Asa60  
MV1902-2  
Asa Light MV

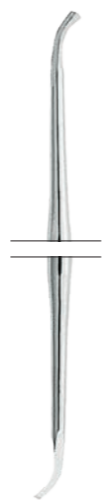

**1/2**  
1905-02  
Asa60  
MV1905-02  
Asa Light MV



**1**  
1901-1  
Asa60



**1L**  
**left**  
1900-1L  
Asa60



**H5 Hygienist**  
1909-H5  
Asa60



**1 Jacquette**  
ML1906-1  
Leonardo ML



**1R**  
**right**  
1900-1R  
Asa60



**H6 Hygienist**  
1909-H6  
Asa60



**2 Jacquette**  
ML1906-2  
Leonardo ML



**2L**  
**left**  
1900-2L  
Asa60



**H7 Hygienist**  
1909-H7  
Asa60



**3 Jacquette**  
ML1906-3  
Leonardo ML



**2R**  
**right**  
1900-2R  
Asa60



**33**  
1906-33  
Asa60

Periosteals and Elevators

Periosteals and Elevators

3 mm  
LANCE TIP



3 mm  
ROUNDED TIP

**Buser**  
PR1850-M  
Perfection

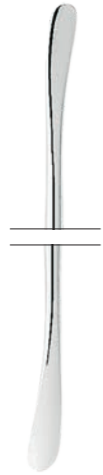

**GF Goldman-Fox**  
MV1850-GF  
Asa Light MV

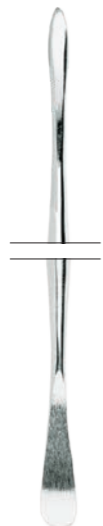

**Beale**  
5114-1  
Octagonal

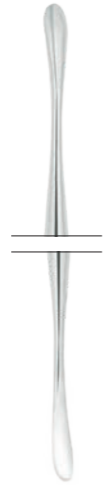

**M7 Molt**  
MV1850-M7  
Asa Light MV



**9A Allen**  
MV1850-9A  
Asa Light MV

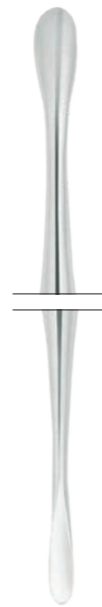

**M8 Molt**  
MV1850-M8  
Asa Light MV

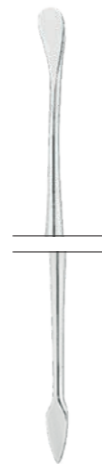

**2 Hourigan**  
MV1851-2  
Asa Light MV

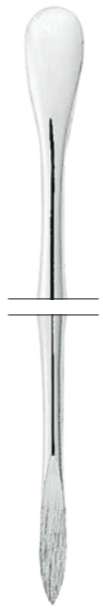

**M9 Molt**  
MV1850-M9  
Asa Light MV



**PR3 Prichard**  
MV 1851-PR3  
Asa Light MV



**Partsch**  
14.5 cm  
1849-1  
Asa60



**1 Hopkins**  
MV1852-1  
Asa Light MV



**3 Mead**  
MV1854-3  
Asa Light MV

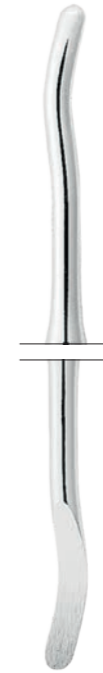

**2 Hopkins**  
MV1852-2  
Asa Light MV

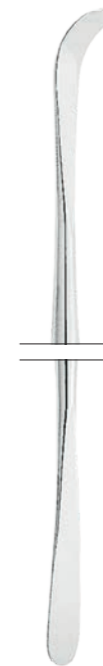

**15 Freer**  
MV1853-15  
Asa Light MV



**16 Freer**  
MV1853-16  
Asa Light MV

Periosteals and Elevators

Periosteals and Elevators

2 mm



2.5 mm

17 cm  
PR1850-1  
Perfection



22 Seldin  
retractor  
1855-22



23 Seldin  
retractor  
1855-23



König  
15.5 cm  
1858-1



Williger  
17 cm  
1856-1



Williger  
16 cm  
1856-2



Williger  
16 cm  
1857-1



Williger  
13 cm  
1857-2

Bone currettes

**1 Hemingway**  
2000-1  
Asa60  
MV 2000-1  
Asa Light MV  
ML2000-1  
Leonardo ML  
MC2000-1  
● Magic Color MC

**2 Hemingway**  
2000-2  
Asa60  
MV 2000-2  
Asa Light MV  
ML2000-2  
Leonardo ML  
MC2000-2  
● Magic Color MC

**3 Hemingway**  
2000-3  
Asa60  
MV 2000-3  
Asa Light MV  
ML2000-3  
Leonardo ML  
MC2000-3  
● Magic Color MC

**4 Hemingway**  
2000-4  
Asa60  
MV2000-4  
Asa Light MV  
ML2000-4  
Leonardo ML

**85 Lucas**  
2001-85  
Asa60  
MV2001-85  
Asa Light MV  
ML2001-85  
Leonardo ML

**86 Lucas**  
2001-86  
Asa60  
MV2001-86  
Asa Light MV  
ML2001-86  
Leonardo ML

**87 Lucas**  
2001-87  
Asa60  
MV2001-87  
Asa Light MV  
ML2001-87  
Leonardo ML

**88 Lucas**  
2001-88  
Asa60  
MV2001-88  
Asa Light MV  
ML2001-88  
Leonardo ML

Bone currettes

**00/0 Williger**  
14 cm  
2015-00

**1/2 Williger**  
14 cm  
2015-1

**00/0**  
14 cm  
2016-00

**1/2**  
14 cm  
2016-1

**2**  
U.S.A. model  
16 cm  
2013-2

**2R**  
U.S.A. model  
16 cm  
2013-2R

**2L**  
U.S.A. model  
16 cm  
2013-2L

Files

Bone files



**3/7 Hirschfeld**  
1810-07  
Asa60  
MV1810-07  
Asa Light MV

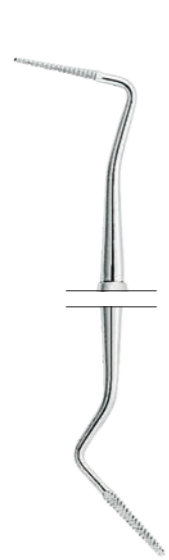

**1S/2S Sugarman**  
1812-02S  
Asa60  
MV1812-02S  
Asa Light MV

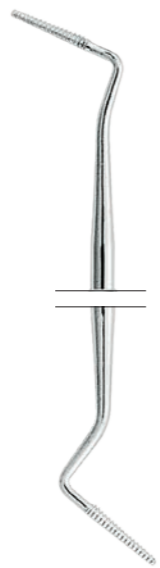

**3S/4S Sugarman**  
1812-04S  
Asa60  
MV1812-04S  
Asa Light MV

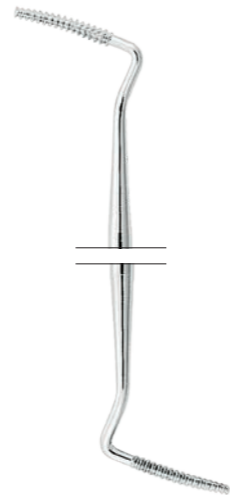

**9/10 Schluger**  
1813-10  
Asa60  
MV1813-10  
Asa Light MV

1812-04S



**1 Polokoff**  
2003-1



**33**  
2004-33



**12 Howard**  
2008-12



**45 Miller**  
2005-45



**12A**  
2007-12A

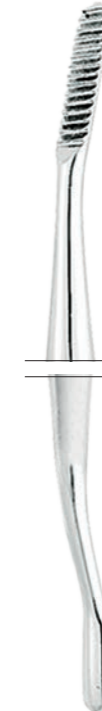

**64 Miller**  
2005-64



**12CA**  
2007-12CA

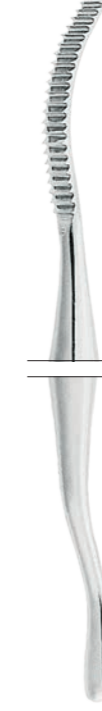

**10**  
2006-10

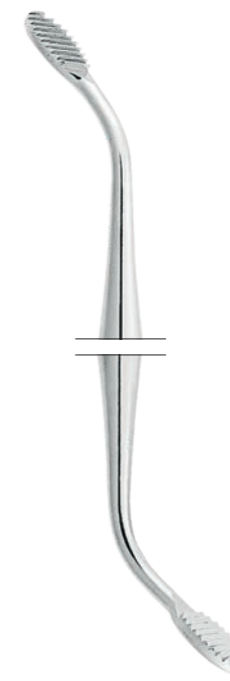

**1 Wahl**  
MV2002-1  
Asa Light MV

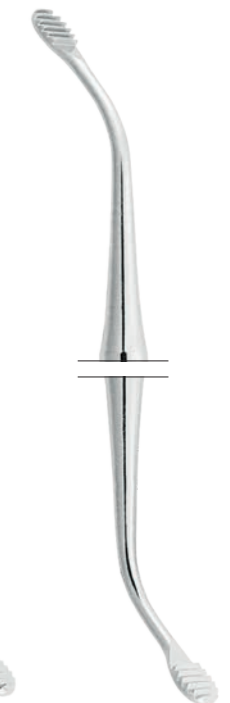

**2 Wahl**  
MV2002-2  
Asa Light MV

Gingivectomy knives

Gingivectomy knives



1 (15K) Kirkland  
1803-1  
Asa60



2 (16K) Kirkland  
1803-2  
Asa60



1 Orban  
1804-1  
Asa60



2 Orban  
1804-2  
Asa60



1/2 (15K/16K) Kirkland  
1803-D  
Asa60  
MV1803-D  
Asa Light MV  
ML1803-D  
Leonardo ML

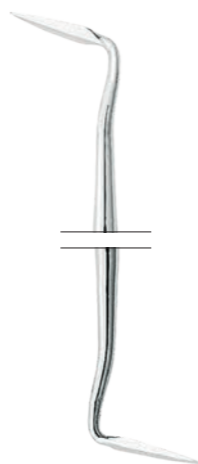

5/6 Buck  
1816-06  
Asa60  
ML1816-06  
Leonardo ML



1/2 Orban  
1804-D  
Asa60  
MV1804-D  
Asa Light MV  
ML1804-D  
Leonardo ML



7 Goldman-Fox  
1815-7  
Asa60

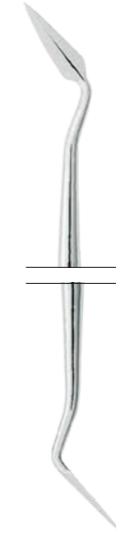

8 Goldman-Fox  
1815-8  
Asa60



1/2 Sanders  
1817-02  
Asa60

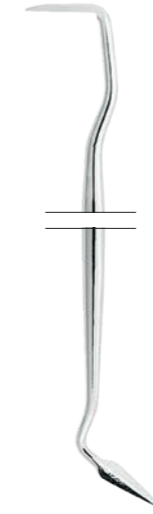

9 Goldman-Fox  
1815-9  
Asa60

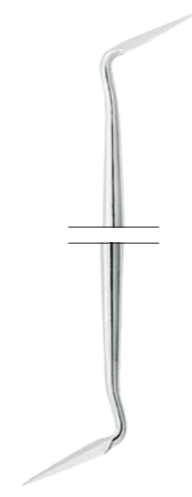

4/5 Sanders  
1817-05  
Asa60

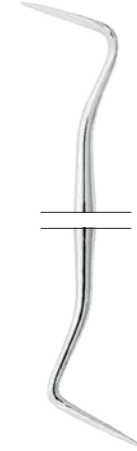

11 Goldman-Fox  
1815-11  
Asa60

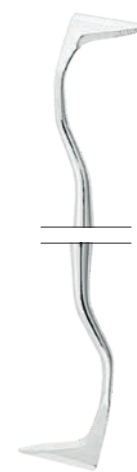

19/20  
(University of  
South California)  
USC Towner  
1818-20  
Asa60

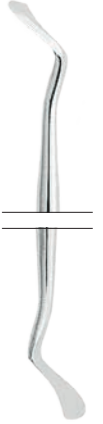

3/4 Buck  
1816-04  
Asa60

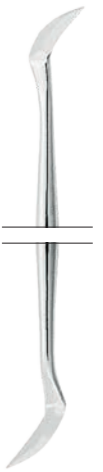

CK3 Crane-Kaplan  
1819-CK3  
Asa60

Chisels

Bone chisels and gouges



**3 Ochsenbein**  
1802-3  
Asa60  
MV1802-3  
Asa Light MV

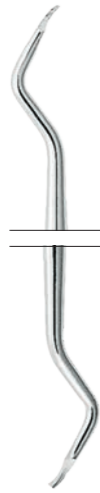

**4 Ochsenbein**  
1802-4  
Asa60  
MV1802-4  
Asa Light MV

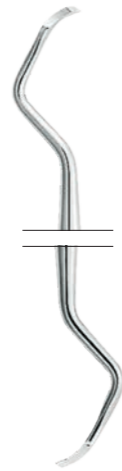

**36/37 Rhodes back-action**  
1811-37  
Asa60  
MV1811-37  
Asa Light MV



**1 TG Chisel**  
1801-1  
Asa60



**2 TG Chisel**  
1801-2  
Asa60



**1/2 TG Chisel**  
1801-D  
Asa60  
MV1801-D  
Asa Light MV



**1 Ochsenbein**  
1800-1



**2 Ochsenbein**  
1800-2



**6 Gardner**  
1832-6



**1 Gardner**  
1832-1



**1W Wakefield**  
1833-1W



**2 Gardner**  
1832-2



**2W Wakefield**  
1833-2W



**5 Gardner**  
1832-5



**3 Buckley**  
1834-3



**5R Gardner**  
1832-5R

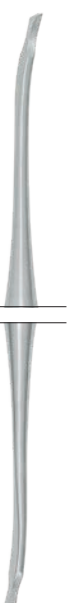

**17 cm**  
PR1801-1  
Perfection

Bone chisels and gouges

3 mm



Partsch  
13.5 cm  
1835-3

4 mm



Partsch  
13.5 cm  
1835-4

5 mm



Partsch  
13.5 cm  
1835-5

6 mm



Partsch  
13.5 cm  
1835-6

3 mm



Partsch  
13.5 cm  
1837-3

4 mm



Partsch  
13.5 cm  
1837-4

5 mm



Partsch  
13.5 cm  
1837-5

6 mm



Partsch  
13.5 cm  
1837-6

3 mm



Partsch  
17 cm  
1836-3

4 mm



Partsch  
17 cm  
1836-4

5 mm



Partsch  
17 cm  
1836-5

6 mm



Partsch  
17 cm  
1836-6

3 mm



Partsch  
17 cm  
1838-3

4 mm



Partsch  
17 cm  
1838-4

5 mm



Partsch  
17 cm  
1838-5

6 mm



Partsch  
17 cm  
1838-6

Mallets

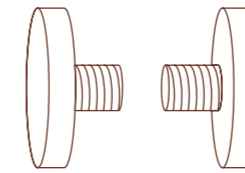

1881-R  
#2 Teflon inserts  
autoclavable  
max 120°

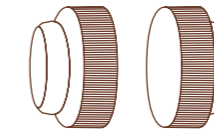

interchangeable  
Ferozell  
inserts



Partsch  
19 cm  
1880  
lead filled



Mead  
19.5 cm  
1881



Mead  
17 cm  
1882



Vickers  
19 cm  
1884



Herbert  
19 cm  
1885

Periodontal instruments

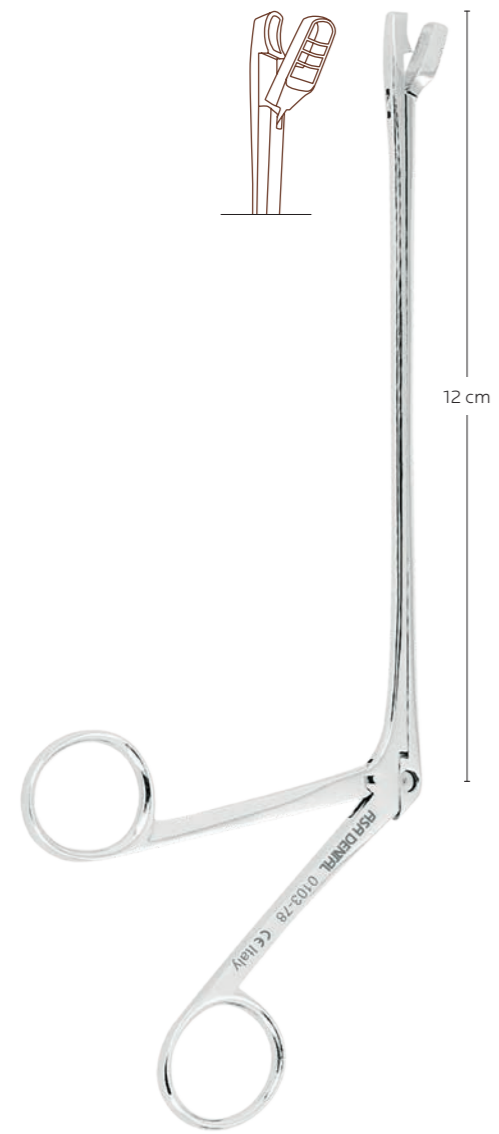

**Tomati**  
19 cm  
0103-78  
gum guillotine forceps



**Goldman-Fox**  
10 cm  
0103-60  
bone/soft tissue nipper  
small beaks for use in limited  
access areas



**Mini Friedman**  
12 cm  
0103-25  
bone rongeurs

Periodontal pocket markers

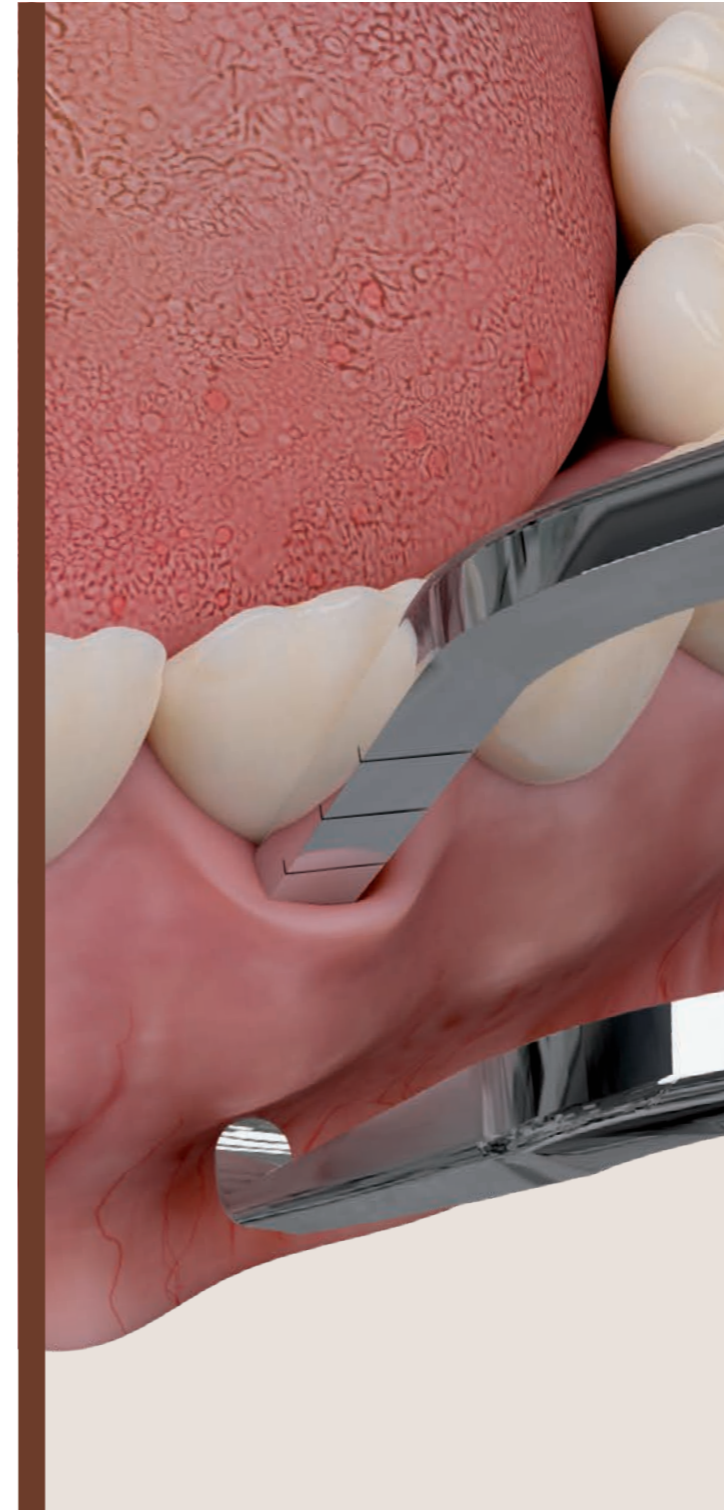

0650-2

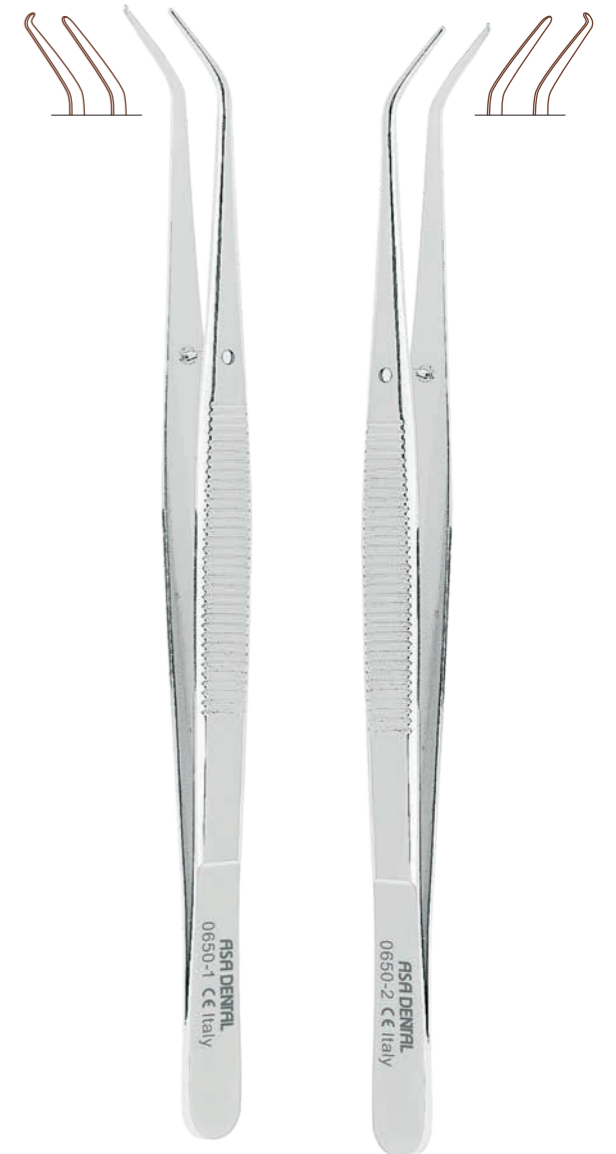

**1 (Crane-Kaplan)**  
Goldman-Fox  
15 cm  
0650-1

**2 (Crane-Kaplan)**  
Goldman-Fox  
15 cm  
0650-2

**Grinding stones**

beige India Corundum grinding stone, for sharpening and re-contouring of very blunt instruments

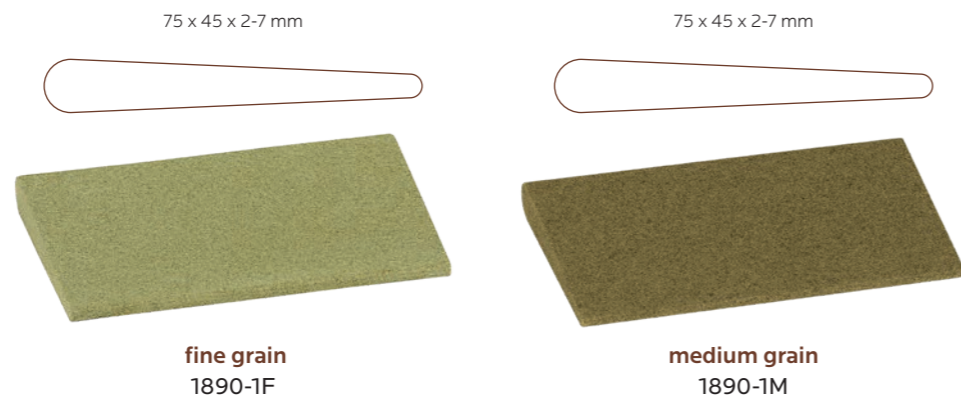

grey-white "Arkansas" grinding stone, for repeated sharpening of scalers and curettes as well as for finishing



white Super "Arkansas" grinding stone, for repeated sharpening of scalers and curettes as well as for finishing

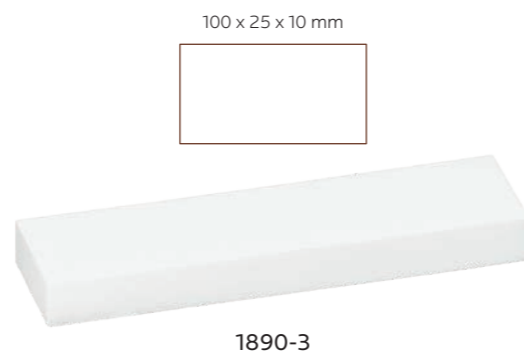

Arkansas grinding stone, convex file, for finishing

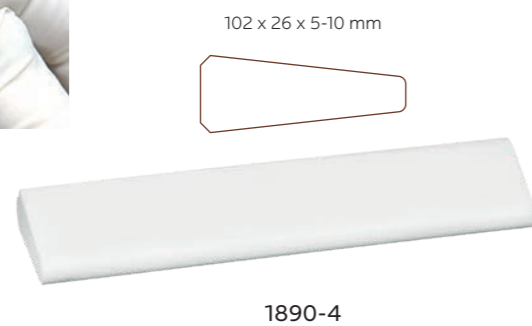

brown beige India Corundum grinding stone, round file, for deburring working ends



**Grinding stones**



grey-white "Arkansas" round section, grinding stone, for deburring working ends

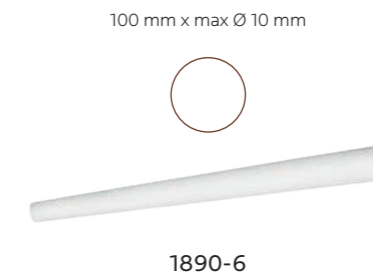

green silicon carbide grinding stone, tapered, for deburring working ends

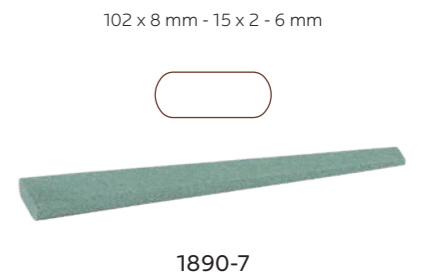

plexiglass test rod for checking sharpness of scalers and curettes  
6 pcs / bag



S1890 case with grinding stones and oil



Asa Oil 40 ml 8001 oil for grinding stones, physiologically safe

Gracey curettes

set of 3



08 · 12 · 14  
S1807-3  
Asa60

set of 7



02 · 04 · 06 · 08 · 10 · 12 · 14  
S1807  
Asa60  
SMV1807  
Asa Light MV  
SML1807  
Leonardo ML  
SLV1807  
Leonardo Light LV  
SMC1807  
Magic Color MC

set of 3



08AF · 12AF · 14AF  
S1807AF-3  
Asa60

set of 7



02AF · 04AF · 06AF · 08AF  
12AF · 14AF · 16AF  
S1807AF  
Asa60  
SML1807AF  
Leonardo ML  
SLV1807AF  
Leonardo Light LV

set of 3



08MF · 12MF · 14MF  
S1807MF-3  
Asa60

set of 7



02MF · 04MF · 06MF · 08MF  
12MF · 14MF · 16MF  
S1807MF  
Asa60  
SML1807MF  
Leonardo ML  
SLV1807MF  
Leonardo Light LV

Periodontal instruments kit

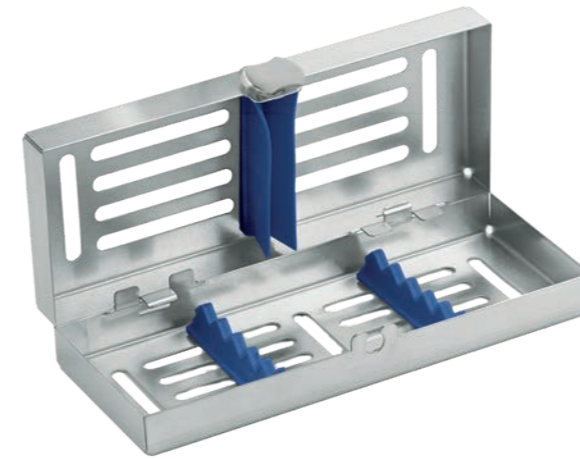

SMC1807-5



1/2	Gracey curette	MC1807-02
11/12	Gracey curette	MC1807-12
13/14	Gracey curette	MC1807-14
6S	mini Crane-Kaplan curette	MC1829-CK6S
U15/33	Towner-Jaquette scaler	MC1902-1
2	London-College cotton and dressing pliers	0601-2
	mini locking tray	2772-1



S1899

2	Goldman-Fox gum scissors curved, sawed edge	0304-2
1	Goldman-Fox periodontal pocket marker right side	0650-1
2	Goldman-Fox periodontal pocket marker -left side	0650-2
	Williams periodontal pocket probe	0703L-1
15K/16K	Kirkland gingivectomy knife	1803-D
1/2	Orban gingivectomy knife	1804-D
5/6	Gracey curette	1807-06
11/12	Gracey curette	1807-12
13/14	Gracey curette	1807-14
1	Goldman-Fox Universal scaler	1809-1
5/6	Buck gingivectomy knife	1816-06
13/14	Mc Call scaler	1825-14
6	Crane-Kaplan scaler	1829-CK6
U15	Towner scaler	1903
M9	Molt periosteal elevator	MV1850-M9

Periodontal instruments

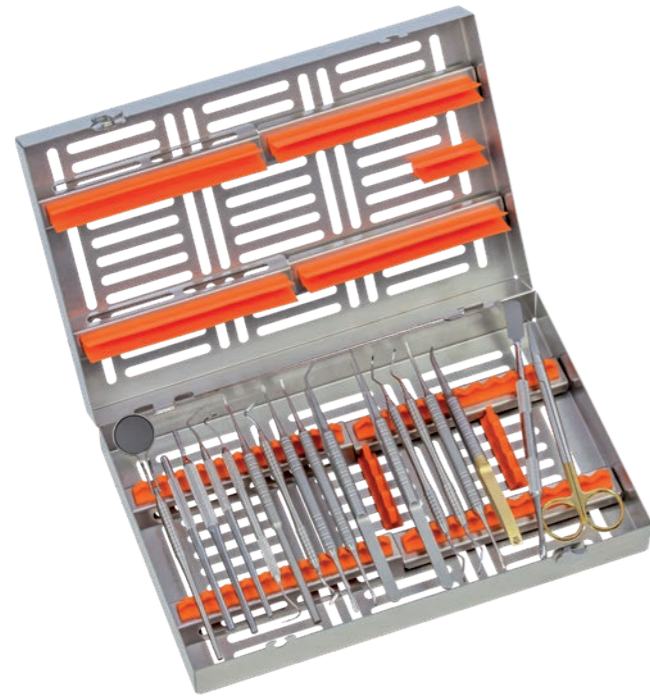

periodontal surgery kit  
SPR2781-P

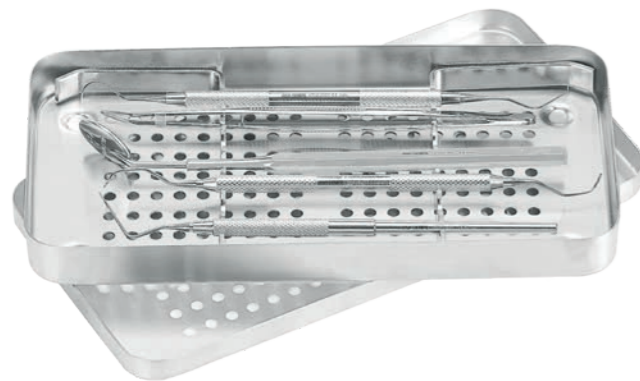

periodontal first examination kit  
S0600-1



S3003-9

	mouth mirror handle	ML2101
5	double sided mouth mirrors	22305
CP-15	periodontal pocket probes	0702L-15
2N	double ended periodontal pocket probes	0708L-2N
	micro-blade holder	0365-1
5	scalpel handle and blade	0350-5
	exciser	PR1857-1
1/2	Orban gingivectomy knife	ML1804-D
PR3	Prichard periosteal periosteal elevator	MV1851-PR3
	papilla periosteal	PR1850-1
	tissue pliers	PR0625-3
	atraumatic tissue pliers	PR0632-1
2R/2L	periodontal instrument	ML1806-2RL
4R/4L	periodontal instrument	ML1806-4RL
	small bone chisel	PR1801-1
	Castroviejo needle holder	PR0460-15TC
2TC	gum scissors	0309-2TC
	sterilization cassette	2780-1A

	mouth mirrors handle	2102-IN
4	plane mouth mirror	2200-4
23/17	double-ended explorer	0704-23D1
1N	periodontal pocket probe	0708-1N
CP-12	periodontal pocket probe	0702L-12
2	London-College cotton and dressing pliers	0601-2
	instrument tray	S2702

M9	Molt periosteal	MV1850-M9
PR3	Prichard periosteal	MV1851-PR3
GF	Goldman-Fox periosteal	MV1850-GF
15K/16K	Kirkland knife	MV1803-D
	Mead mallet	1881
	Castroviejo needle holder	0446-14TC
	Mathieu needle holder	0435-17TC
3	scalpel handle	0350-3
	instrument tray	S2722-1

Periodontal instruments



S3003-11

Instrument Set realised according to the instructions of Prof. GUIDO GORACCI, senior Professor at the Department of Conservative Dentistry of "LA SAPIENZA", Rome University



S1800-23

3	scalpel handle	0350-3
	Sternberg retractor	2602-1
2	Goldman-Fox scissor	0304-2
M9	Molt periosteal	MV1850-M9
PR3	Prichard periosteal	MV1851-PR3
	Crile Wood needle holder	0415-15TC
1	Semken Taylor tissue plier	0631-1
23	explorer	0700-23
	mouth mirror handle	2102-IN
5	mouth mirror	2200-5
11	disposable blades (100 pcs)	0351-11
	instrument tray	S2722-1

36/37	Rhodes back-action file	1811-37
15K	Kirkland knife	1803-1
3/4	Buck knife	1816-04
7	Goldman-Fox knife	1815-7
1/2	Sanders knife	1817-02
HU 1/2	Langer curette	1805-02
5/6	Bernhart scaler	1821-06
3/4	Rule scaler	1823-R04
1	De Marco scaler	1808-1
5	Goldman-Fox scaler	1809-5
6	Goldman-Fox scaler	1809-6
11/12	McCall curette	1825-12
11A/12A	McCall curette	1825-12A
204	curette	1827-204
31/32	Jacquette curette	1831-32
H5/33	curette	1904-H5
3/7	Hirschfeld file	1810-07
1S/2S	Sugarman file	1812-02S
3S/4S	Sugarman file	1812-04S
1/2	chisel	1801-D
2	De Marco scaler	1808-2
2	Kirkland knife	1803-2
4	Ochsenbein bone chisel	1802-4
	instrument tray	S2720-2



# ORTHODONTIC

MADE IN ITALY

## MAKING THE RIGHT ADJUSTMENTS

A packed agenda that gets usually busier after school time, lots of young clients and many opportunities to positively contribute to healthier mouths and more pleasing appearances. This is your day as an orthodontist, a flow of 10 to 30 minutes appointments whose difficulty hugely varies, from routine alignments to complex detached braces or painful shifting of the archwire. Regardless of that, you need reliable instruments that can help you perform confidently and effectively. Asa Dental offers two different lines of products. Premium instruments are dedicated to professionals demanding unrivalled quality and ergonomics in every situation, with all the other pliers and cutters offering the ideal trade-off between performance and convenience. We believe in quality outcomes but we also believe in dental care accessible to everyone.

- H4 Cutters
- H10 Wire forming pliers
- H29 Utility pliers
- H34 Hand instruments
- H37 Prothesis boxes

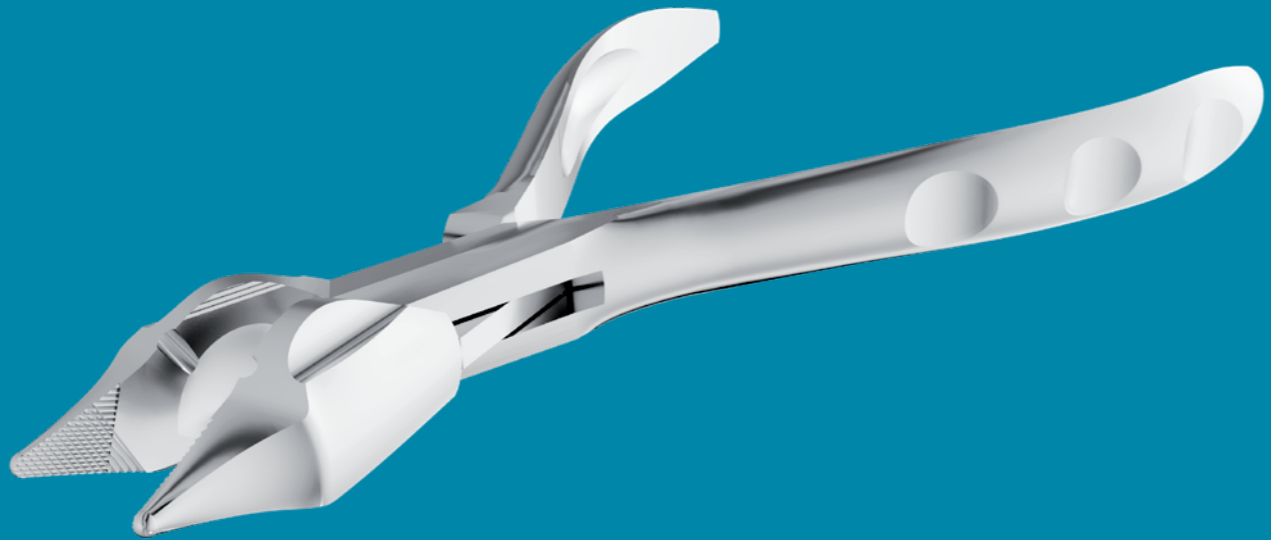

How to read this chapter



Premium orthodontic instrument



Premium orthodontic instrument with tungsten carbide (TC) inserts



standard instrument



standard instrument with tungsten carbide (TC) inserts

How to use

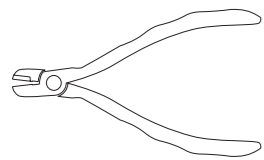

full view  
Premium orthodontic instrument  
code starts with 88

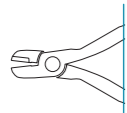

partial view  
standard instrument  
code starts with 58

when full and partial view  
are in the one page  
they refer to the same instrument,  
premium and standard version

Technical drawing



drawings provide additional  
information about shape

## Cutters

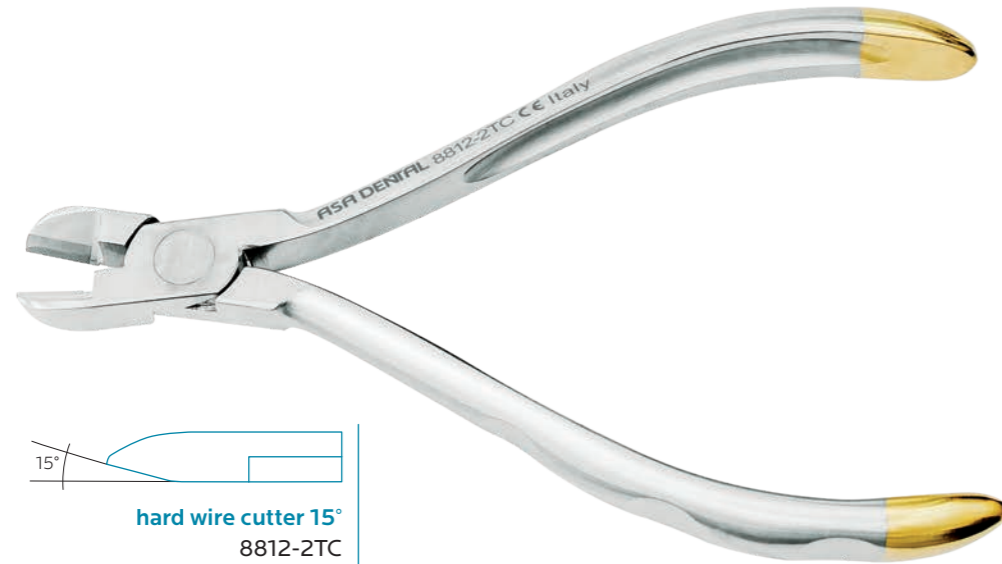

**hard wire cutter 15°**  
8812-2TC

15° angle to better reach areas of difficult access.  
Wire size:  
max. 0.56 mm x 0.70 mm  
(0.022" x 0.028")



**universal distal-end-cutter no hold**  
8813-1TC

Mini universal distal end cutter, without safety hold.  
Cuts flush to the bracket or buccal tube.  
Wire size: max. 0.56 mm x 0.70 mm  
(0.022" x 0.028")

## Cutters



**distal end flush cutter**  
8826-1TC

15° angle to better reach areas of difficult access.  
Wire size: max. 0.56 mm x 0.70 mm  
(0.022" x 0.028")

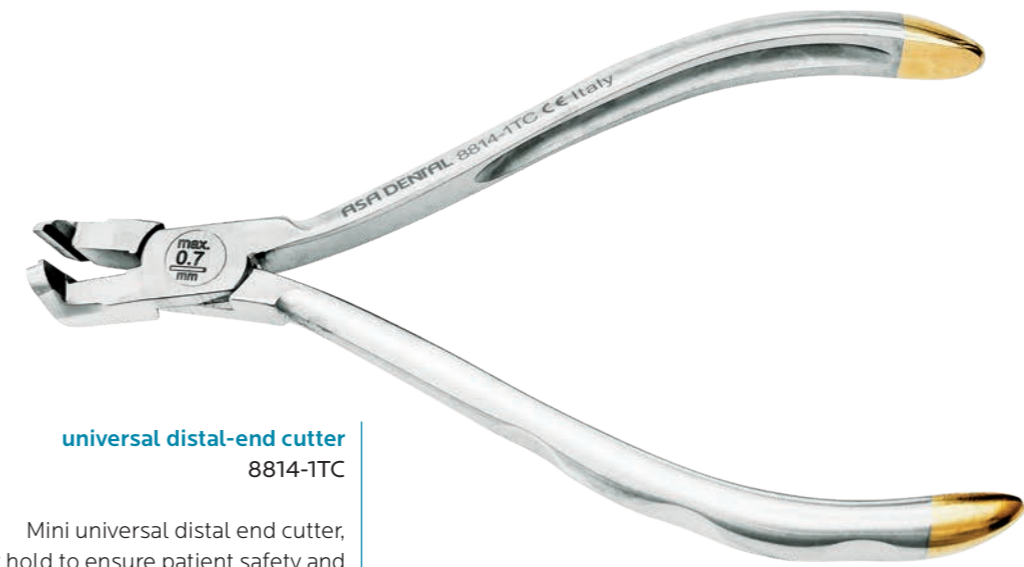

**universal distal-end cutter**  
8814-1TC

Mini universal distal end cutter, with safety hold to ensure patient safety and comfort during use.  
Wire size: max. 0.56 mm x 0.70 mm  
(0.022" x 0.028")

## Cutters

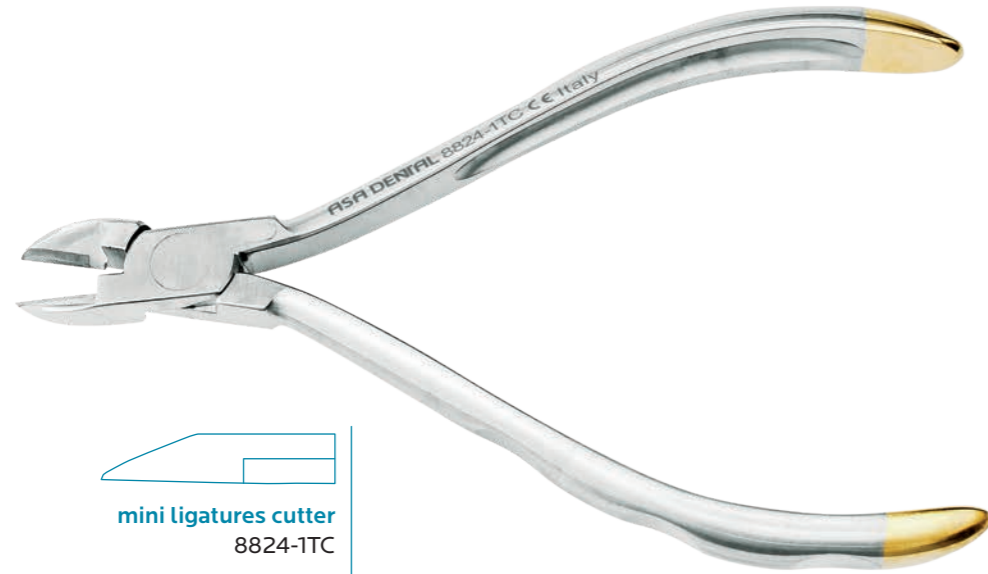

**mini ligatures cutter**  
8824-1TC

Ligature cutter for hard wires, straight.  
Slim profile to better access difficult areas.  
Wire size: max. 0.40 mm (0.015")

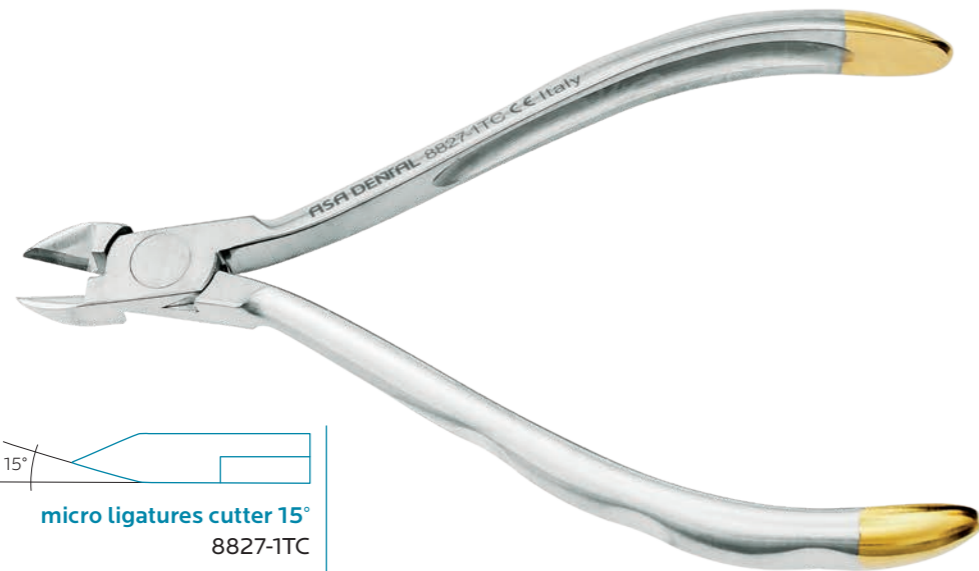

**micro ligatures cutter 15°**  
8827-1TC

Ligature cutter for hard wires, 15° angle.  
Ultra slim profile to reach  
areas of difficult access.  
Wire size: max. 0.40 mm (0.015")

## Cutters



**multi-use wire cutter**  
8812-1TC

Versatile hard wire cutter.  
Wire size: max. 0.56 mm x 0.70 mm  
(0.022" x 0.028")



**multi-use wire cutter**  
5832



**multi-use wire cutter**  
5832-1TC

Same as 5832 with tungsten carbide inserts

## Cutters



**micro-miniature wire cutter**  
5833

Ultra slim profile soft wire cutter for ligature wires.  
Designed to enhance access in difficult areas.  
Wire size: max. 0.30 mm (0.012")



**micro-miniature wire cutter**  
5833-1TC

Same as 5833 with tungsten carbide inserts



**wire cutter <= 0.9 mm**  
5880-1

Designed to cut wire pins and ligature wires,  
it is strong enough to bend archwire ends after distal cutting.  
Wire size: max. 0.9 mm (0.036")



**wire cutter <= 1.5 mm**  
5880-2

Designed to cut wire pins and ligature wires,  
it is strong enough to bend archwire ends after distal cutting.  
Wire size: max. 1.5 mm (0.044")

## Cutters



**wire cutter <= 1.2 mm**  
5880-3TC

Designed to cut wire pins and ligature wires,  
it is strong enough to bend archwire ends after distal cutting.  
Wire size: max. 1.2 mm (0.044").  
With tungsten carbide inserts



**distal end cutter**  
5836

Distal end cutter with safety hold designed to cut hard wires  
and hold the loose distal end, preventing damages  
to patient oral tissue.  
Wire size: rectangular max. 0.56 mm x 0.7 mm (0.022" x 0.028")  
round max. 0.5 mm (0.020")



**distal end cutter**  
5836-1TC

Same as 5836 with tungsten carbide inserts



**micro distal end cutter**  
5837

Distal end cutter with safety hold designed to cut hard wires  
and hold the loose distal end, preventing damages  
to patient oral tissue.  
Wire size: rectangular max. 0.56 mm x 0.7 mm (0.022" x 0.028")  
round max. 0.5 mm (0.020")

Wire forming pliers

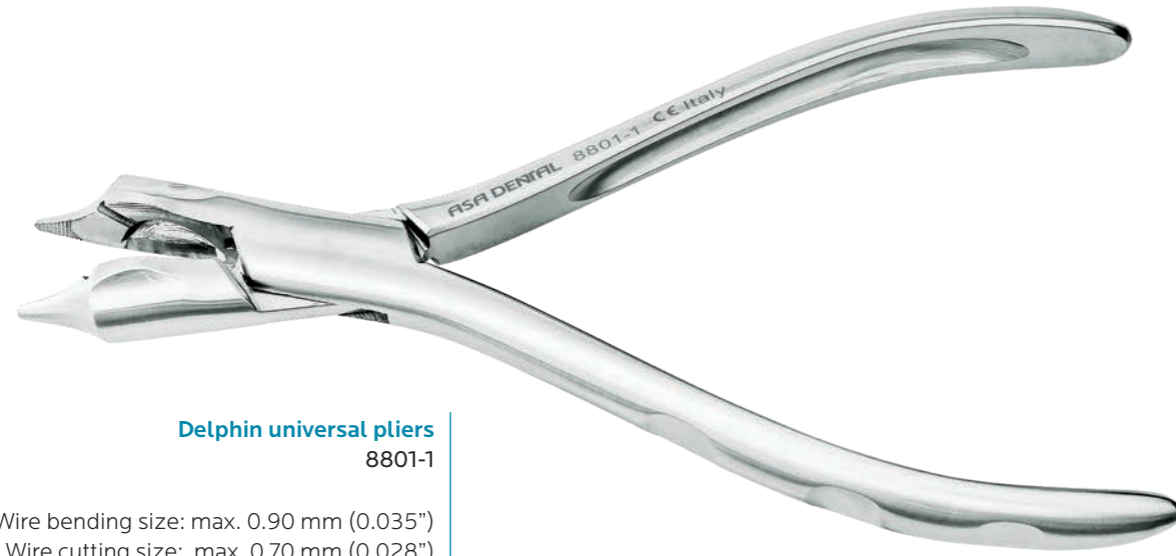

**Delphin universal pliers**  
8801-1

Wire bending size: max. 0.90 mm (0.035")  
Wire cutting size: max. 0.70 mm (0.028")



**Delphin universal pliers**  
5801-1



**universal pliers**  
8801-2

Wire bending size: max. 0.90 mm (0.035")  
Wire cutting size: max. 0.70 mm (0.028")



**universal pliers**  
5801-3

Wire forming pliers



**Waldsachs pliers**  
8802

Wire bending size: max. 0.90 mm (0.035")  
Wire cutting size: max. 0.70 mm (0.028")



**Waldsachs pliers**  
5802



3 mm (0.118")  
4 mm (0.157")  
5 mm (0.197")  
6 mm (0.236")

**Nance precision pliers**  
8816

For precise forming of loop  
in 4 different lengths: 3, 4, 5 and 6 mm.  
Groove at base aids in closing loops.  
Wire size: max. 0.70 mm (0.028")

Wire forming pliers

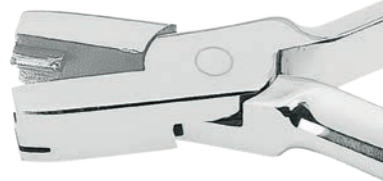

**Nance pliers**  
5800

Nance loop closing pliers, for bending of stop loops and special pliers for Adams' clasps.  
Wire size: max. 0.7 mm (0.028")



**round-concave pliers**  
5806

Round-concave pliers for loop forming and bending of thin round and square.  
Wire size: max. 0.5 mm (0.020")



**Tweed loop pliers**  
5809-1

Loop forming pliers for round and rectangular wires, with replaceable cylindrical beak. The concave beak with parallel serrations firmly holds the wire in position.  
Wire size: max. 0.56 x 0.7 mm (0.022" x 0.028")  
Beak size: 1.15 mm (0.045"), 1.50 mm (0.059"), 1.90 mm (0.075")

Wire forming pliers

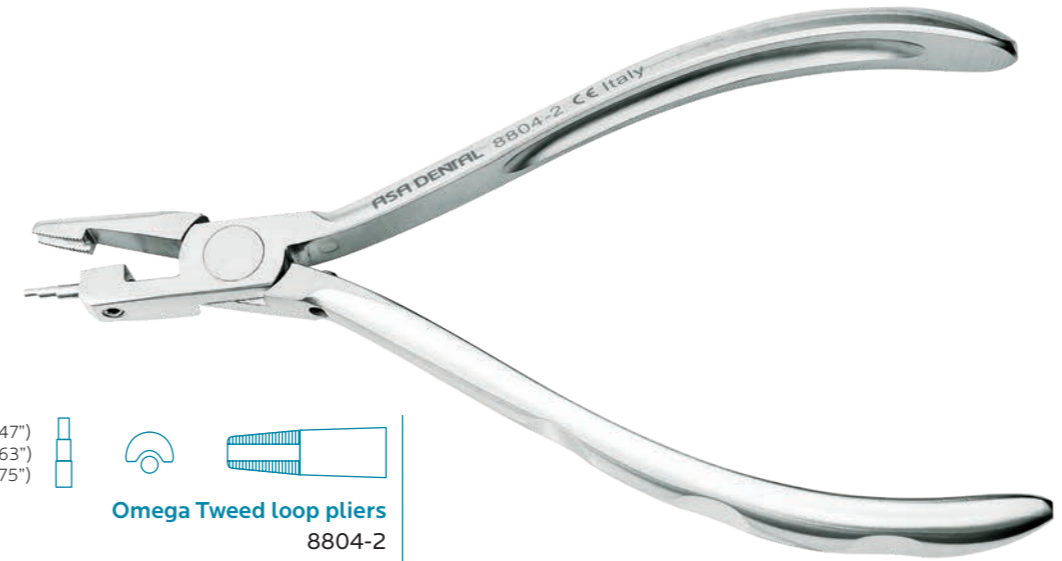

1.20 mm (0.047")  
1.60 mm (0.063")  
2.00 mm (0.075")



**Omega Tweed loop pliers**  
8804-2

Loop forming pliers for round and rectangular wires, with replaceable cylindrical beak. The concave beak with parallel serrations firmly holds the wire in position.  
Wire size: max. 0.70 mm (0.028")



**8804-2P**  
replacement tip for pliers 8804-2



**8804-3P**  
replacement screw and L-key for pliers 8804-2



**Omega Tweed loop pliers**  
5809-2

Wire forming pliers

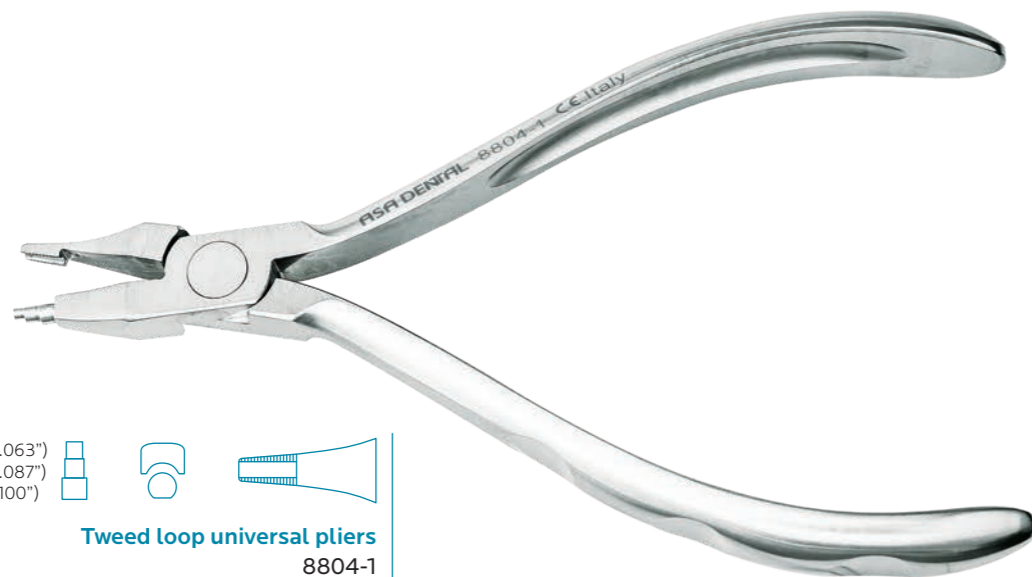

1.60 mm (0.063")  
 2.20 mm (0.087")  
 2.80 mm (1.100")

**Tweed loop universal pliers**  
 8804-1

Loop forming pliers for creating bull and helical loops with different diameters.  
 Wire size: max. 0.70 mm (0.028")



**Tweed loop universal pliers**  
 5870

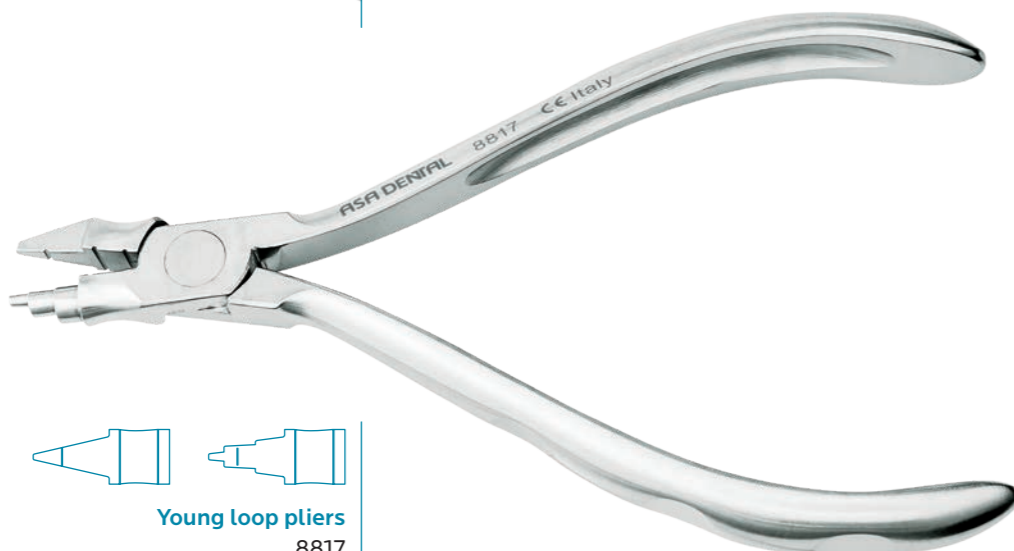

3 mm (0.118")  
 4 mm (0.157")  
 5 mm (0.197")  
 6 mm (0.236")

**Young loop pliers**  
 8817

Loop forming pliers for different lengths and ideal for labial arches.  
 Wire size: max 0.70 mm (0.028")

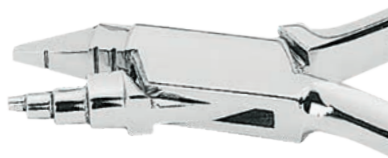

**Young pliers**  
 5863

Wire forming pliers



**Tweed loop pliers**  
 5809-3

Single diameter loop forming pliers with one replaceable beak and a concave serrated one.  
 Wire size: max. 0.56 x 0.7 mm (0.022" x 0.28")  
 Beak size: 1.50 mm (0.059")



**Tweed (Angle) pliers**  
 5872-1

Tweed (Angle) arch bending pliers - short - Pliers with beaks (10 mm) designed for convenient handling of square or rectangular wires the blades are parallel at 0.5 mm (0.020") pliers' opening



**Nance loop pliers**  
 5862

Designed for precise forming of loops in 4 different lengths, for round and rectangular wires.  
 Wire size: max. 0.7 mm (0.028")

Wire forming pliers



**Reynolds pliers**  
8805

Contouring pliers for archwires



**Reynolds pliers**  
5812

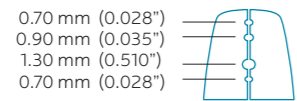
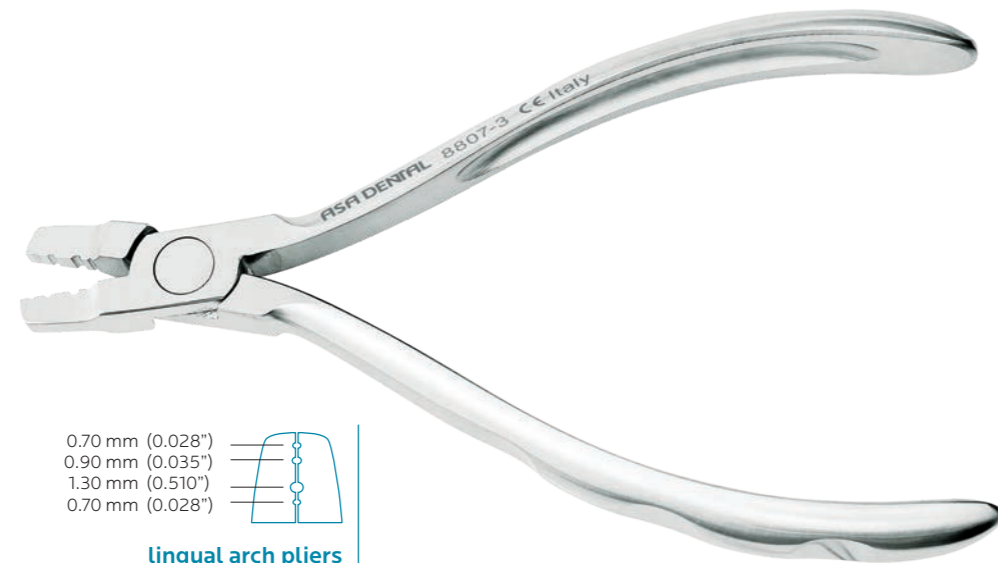

**lingual arch pliers**  
8807-3

0.76 mm - 0.90 mm (0.030" - 0.036")  
Wire size: max. 0.90 mm (0.036")



**lingual arch pliers**  
5818

Wire forming pliers

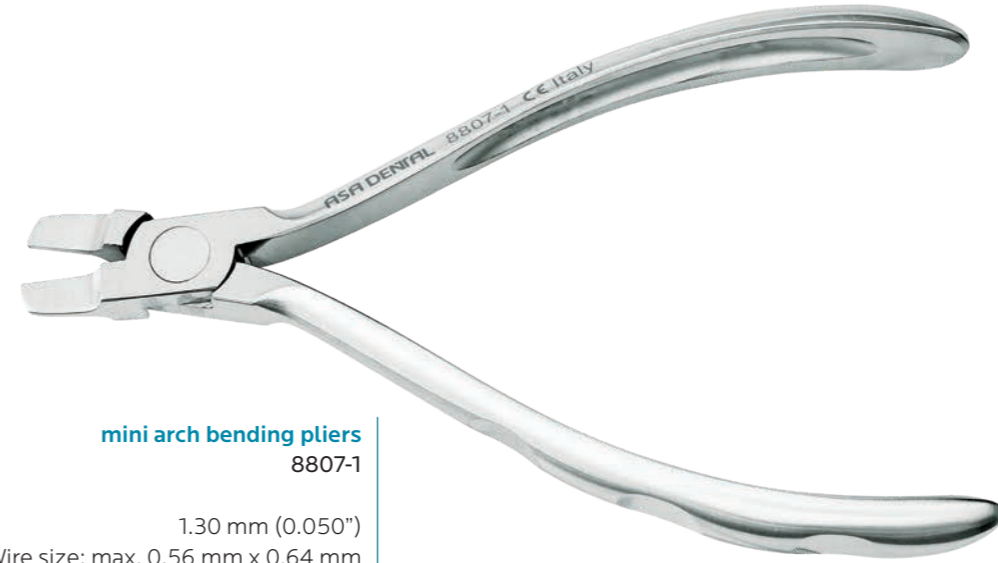

**mini arch bending pliers**  
8807-1

1.30 mm (0.050")  
Wire size: max. 0.56 mm x 0.64 mm  
(0.022" x 0.025")



**arch bending pliers**  
8807-2

1.78 mm (0.067")  
Wire size: max. 0.56 mm x 0.64 mm  
(0.022" x 0.025")

## Wire forming pliers

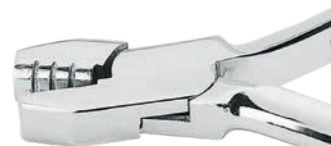

**De La Rosa grooved pliers**  
5821-1

Arch forming pliers. Designed to form and contour arch wires on round or rectangular wire. The beak has grooves of 0.4 mm (0.016"), 0.46 mm (0.018") and 0.56 mm (0.022")

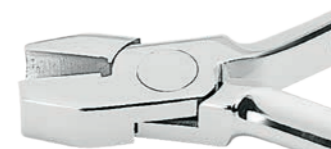

**De La Rosa non-grooved pliers**  
5821-2

Arch forming pliers with a non-grooved contouring surface for the forming of precise arches



**Mc Kellops pliers**  
5860-1

Round and concave heavy wire pliers. For forming loops in hard clasp wires or labial arch wires. Wire size: max. 0.8 mm (0.032")



**flat bending pliers**  
5864

Wire bending pliers, for wires. Wire size: max. 0.9 mm (0.036")

## Wire forming pliers



**short rounded jaws pliers**  
5865

Double rounded jaw wire bending pliers, for wires. Wire size: max. 0.7 mm (0.028")



**long rounded jaws pliers**  
5868

Double rounded jaw wire bending pliers, for wires. Wire size: max. 0,7 mm (0.028")



**Angle pliers**  
5866

Bird Beak Angle pliers for bending round, square or rectangular wire. Wire size: max. 0.7 mm (0.028")



**Angle pliers with cutter**  
5838

Bird beak pliers for bending round, square or rectangular wire. With cutter. Wire size: max. 0,7 mm (0.028")

Wire forming pliers



**Adams pliers**  
8819

Designed for precise angle bends at 90°



**Adams pliers**  
12.2 cm  
5867-1

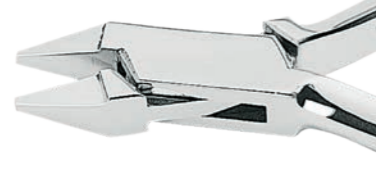

**Adams pliers**  
14.2 cm  
5867-2

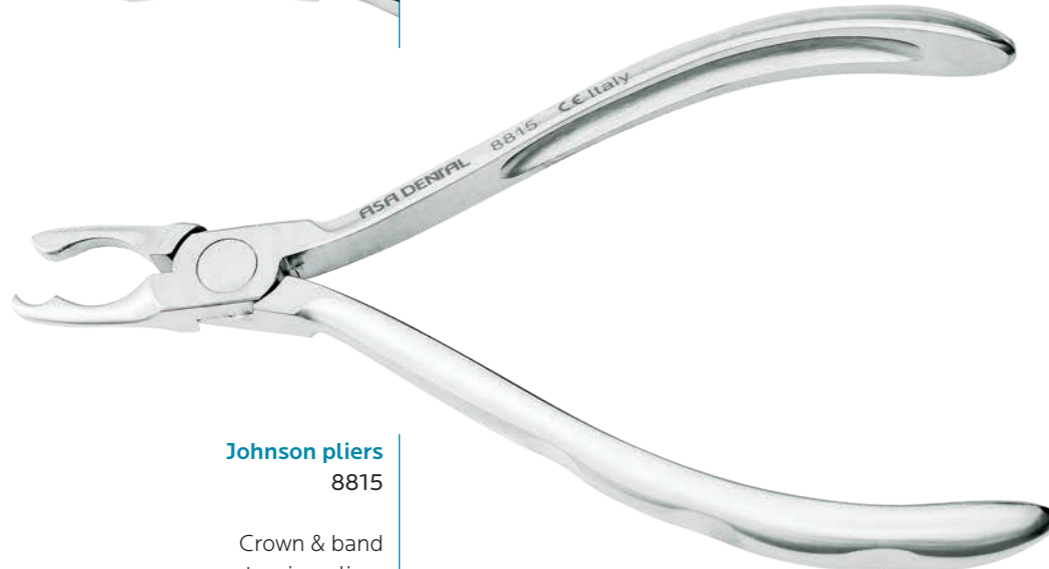

**Johnson pliers**  
8815

Crown & band contouring pliers



**Johnson pliers**  
5861

Wire forming pliers



**Aderer mini pliers**  
8820-1

Three-jaw bending pliers.  
Wire size: max. 0.50 mm (0.020")



**Aderer mini pliers**  
5869-1

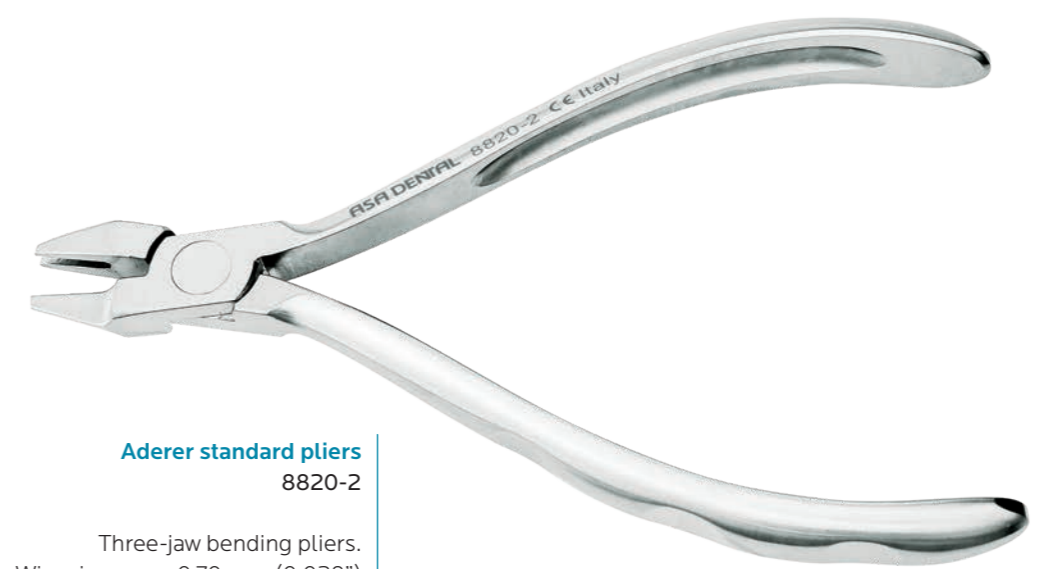

**Aderer standard pliers**  
8820-2

Three-jaw bending pliers.  
Wire size: max. 0.70 mm (0.028")



**Aderer standard pliers**  
5869-2

Wire forming pliers

□  
○

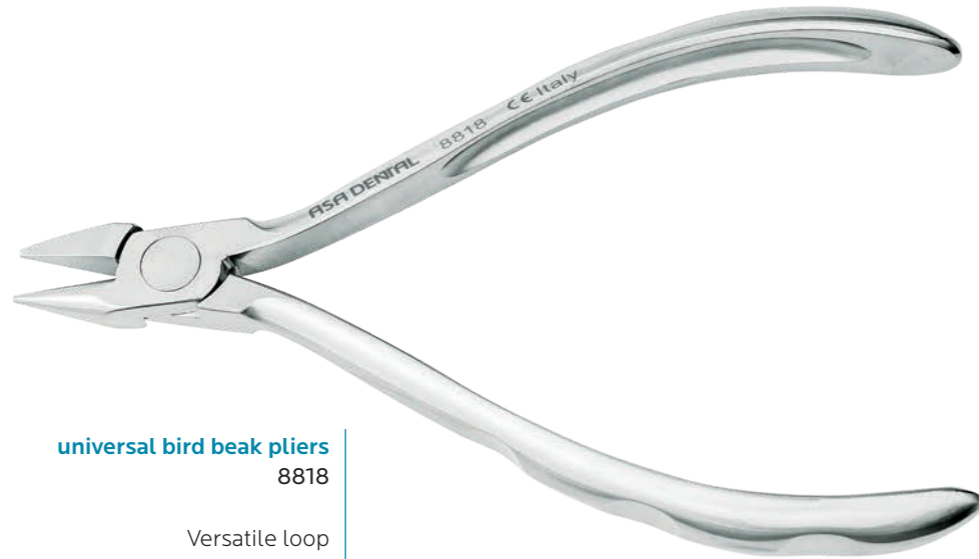

**universal bird beak pliers**  
8818

Versatile loop forming pliers for wires

□  
○

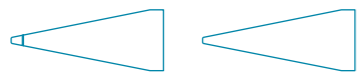

**bird beak pliers**  
8821

Light wire pliers with groove with a longer cone that facilitates forming precise loops. The groove allows locating and duplicating loops. Wire size: max. 0.70 mm (0.028")

Wire forming pliers



**How universal pliers**  
8822-1

Straight. Utility pliers with cross-serrated tips. Perfect to position and remove orthodontic arches and pins



**How universal pliers**  
5874-1



**How curved pliers**  
8822-2

Angled. Utility pliers with cross-serrated tips angled at 40° to easily reach areas of difficult access



**How curved pliers**  
5874-2

## Wire forming pliers

D  
O

**light bird beak pliers**  
5871

Designed for bending round, square or rectangular wires.  
Wire size: max. 0.4 mm (0.016")



**flat bending pliers**  
5875-1

Flat nose pliers with smooth beaks for bending wires.  
Wire size: max. 0.7 mm (0.028")



**flat knurled bending pliers**  
5875-2

Bending wires.  
Wire size: max. 0.7 mm (0.028")



**knurled bending pliers**  
5876-1

Wire size: max. 0.7 mm (0.028")



**bending pliers**  
5876-2

Wire size: max. 0.7 mm (0.028")

## Wire forming pliers



**Schwarz pliers**  
8823

Arrow clasp forming pliers.  
Wire size: max. 0.70 mm (0.028")

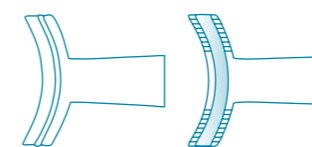

**hammerhead NiTi pliers**  
8825

Multi purpose pliers for easy wire bending and loop forming, without the use of heat

## Wire forming pliers

**optical pliers**  
8803

Pliers with groove,  
excellent for forming helical  
closing loops and wire bending  
of round and rectangular wires.  
Wire size: max. 0.70 mm (0.028")

## Wire forming pliers

**Jarabak pliers**  
8829

Multipurpose light wire bending pliers.  
Grooves allow precise bending  
and closing of loops.  
Wire size: max. 0.70 mm (0.028")

**hollow chop pliers**  
8806

Contouring pliers (De La Rosa).  
Ideal for arch contouring.  
Wire size: max. 0.70 mm (0.028")

**V-stop pliers**  
8830

Designed to place V-bend in arch wires,  
including nickel titanium and  
prevent archwire from travelling.  
Wire size: max. 0.70 mm (0.028")

Wire forming pliers



Nance precision pliers  
8816



universal Tweed pliers  
8804-1

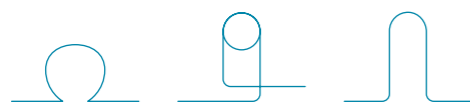

Tweed omega pliers  
8804-2



lingual arch pliers  
8807-3

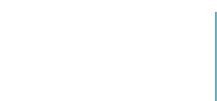

Adams pliers  
8819



hammerhead NiTi pliers  
8825



V-stop pliers  
8830



mini arch bending pliers  
8807-1  
arch bending pliers  
8807-2



Aderer mini pliers  
8820-1  
Aderer standard pliers  
8820-2

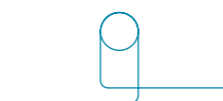

universal bird beak pliers  
8818  
bird beak pliers  
8821

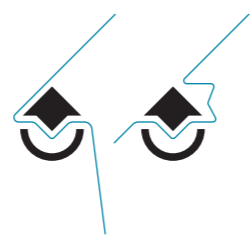

Schwarz pliers  
8823

Utility pliers



Weingart pliers  
8808-1

Utility pliers with cross-serrated tips, ideal for ligatures

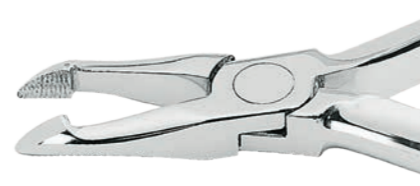

Weingart pliers  
5819

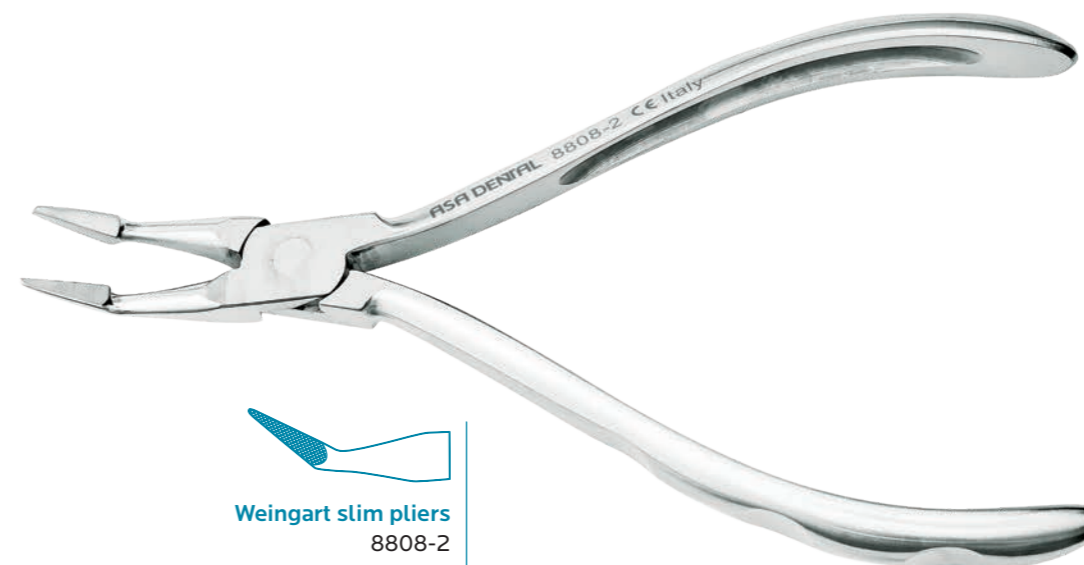

Weingart slim pliers  
8808-2

Slim utility pliers with cross-serrated tips, ideal for ligatures

Utility pliers



**wide beak removing pliers**  
5826-1

Direct bonding bracket remover with "Wide beak" pad. Designed for quick, comfortable removal of direct bonded brackets and elimination of adhesive residues. Wide tip.

**T**

**4.4 mm (1/4")**  
5826-CR1  
replacement pads  
for 5826-1-2, 5828-1-2

**T**

**4.8 mm (3/16")**  
5826-CR2  
replacement pads  
for 5826-1-2, 5828-1-2



**narrow beak removing pliers**  
5826-2

Direct bonding bracket remover with "Narrow beak" pad. Similar to 5826-1



**short posterior band remover**  
8811-1

Posterior band and bracket removing pliers, short. The tip is aligned below the lower end of the occlusal pad.



8811-1P  
replacement for  
8811-1 and 8811-2



**short posterior band remover**  
5828-1

Utility pliers



**long posterior band remover**  
8811-2

Long posterior band and bracket removing pliers, long. The tip is centered on the occlusal pad



8811-1P  
replacement for  
8811-1 and 8811-2



**long posterior band remover**  
5828-2



**wide bracket removing pliers**  
8809

Bracket-removing pliers, straight. Ideal for all types of steel, plastic and ceramic brackets



**wide bracket removing pliers**  
5824-1

Utility pliers



**angled bracket removing pliers**  
8810

Bracket-removing pliers, angled.  
Ideal for all types of steel,  
plastic and ceramic brackets



**angled bracket removing pliers**  
5825



**adhesive removing pliers**  
8831

Adhesive-removing pliers  
with reversible and  
replaceable blade



8831-1P  
replacement for 8831

Utility pliers



**universal band slitter**  
8828-1TC

Band slitter.  
Wire size: max. 0.40 mm (0.015")

8828-1TC

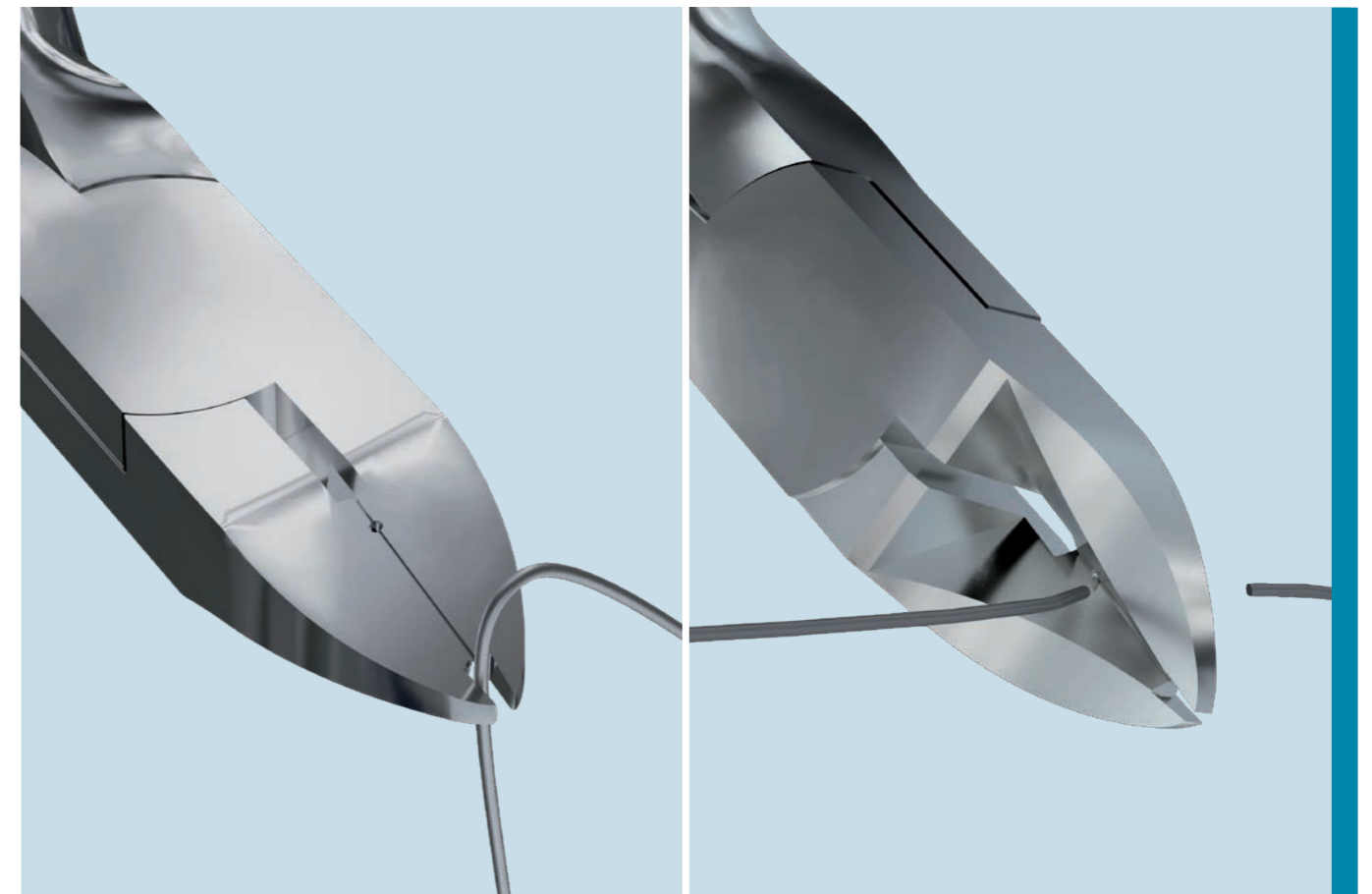

Hand instruments

direct bond bracket holders  
self-holding with reverse action  
will not release the bracket until pressed



13.5 cm  
2400

13.5 cm  
2402

13.5 cm  
2401

band pusher



Mershon  
14 cm  
2410

band setter  
with tin insert



15 cm  
2411

band pusher  
used in all heat  
sterilizers



13.5 cm  
2412

Hand instruments

ligature instruments

band seating and  
removing instruments



1351-1

1350-1

1350-2

elastic  
instrument



1352-1

separating pliers for  
elastics and separators



15.5 cm  
2450

**Hand instruments**

bracket placement marker  
measuring gauge 3.5 / 4.0 / 4.5 / 5.0 mm



8832

elastic forceps

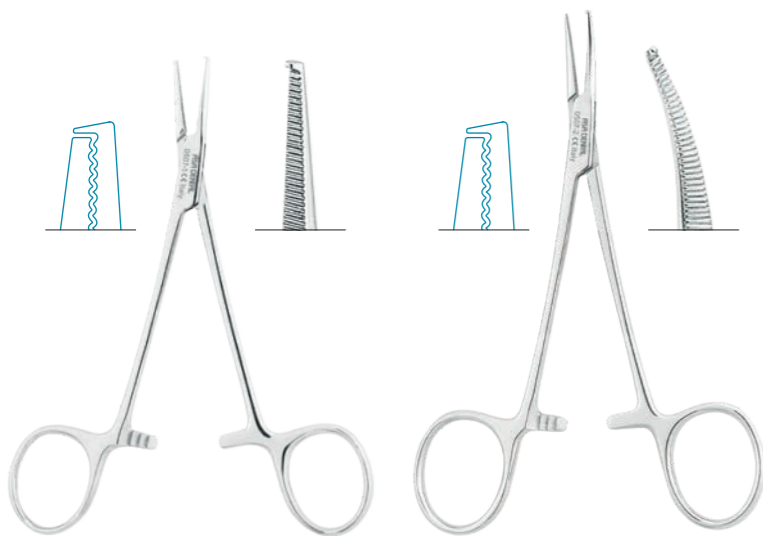

1 Halstead-Mosquito  
straight  
12 cm  
0507-1

2 Halstead-Mosquito  
curved  
12 cm  
0507-2

ligature and archwire tucker

2 mm

3 mm



Luniatschek  
1355-1

Luniatschek  
1355-2

**Ortho/prothesis boxes**

plastic box for removable retainers  
10 pcs / pack



Blue  
6900E-A



White  
6900E-B



Light blue  
6900E-C



Yellow  
6900E-G



Pink  
6900E-R



Green  
6900E-V



# 9

## INSTRUMENT CASSETTES AND TRAYS

MADE IN ITALY

### OPERATIONAL EFFICIENCY MADE EASY

The more your dental studio grows the more effective your procedures need to be. Efficiency becomes a direct consequence of an organized practice with proper instruments handling to reduce waste of time and increase patient's safety. Asa Dental manufactures trays, cassettes and boxes to conveniently transport, sterilize and store those instruments that make your daily practice crucial to improve the quality of life of your patients, whether they need to solve aesthetic or functional problems.

A wide range of accessories complements cassettes and trays to effectively allocate space and prevent damages to delicate parts and coatings during reprocessing steps. Finally, they come in a wide range of size, shapes and materials to meet all the needs of a structured dental studio.

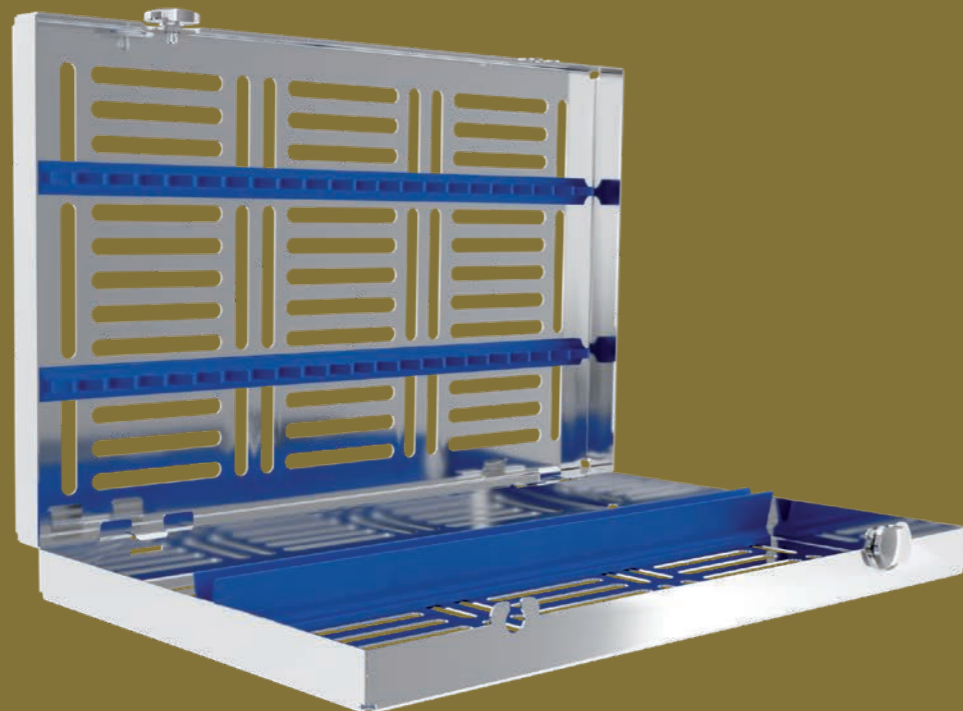

- I2 Steel cassettes
- I4 Steel trays
- I8 Aluminum trays and accessories
- I12 Autoclave instrument protection lubricant
- I13 Aluminum containers
- I13 Aluminum racks
- I13 Sterilizing forceps
- I14 Endodontic boxes
- I17 Bur holders
- I18 Accessories

**Stainless steel instrument cassettes**

LARGE  
288x182x34 mm

complete with silicone insert frame  
for 20 instruments

- Blue  
2770-1
- Orange  
2770-1A
- Red  
2770-1R
- Green  
2770-1V



complete with silicone insert frame  
for 15 instruments

- Blue  
2770-2
- Orange  
2770-2A
- Red  
2770-2R
- Green  
2770-2V



complete with silicone insert frame  
for 10 instruments

- Blue  
2770-3
- Orange  
2770-3A
- Red  
2770-3R
- Green  
2770-3V



288x182x60 mm

- Orange  
2780-1A



MEDIUM  
182x144x34 mm

complete with silicone insert frame  
for 10 instruments

- Blue  
2771-1
- Orange  
2771-1A
- Red  
2771-1R
- Green  
2771-1V



complete with silicone insert frame  
for 5 instruments

- Blue  
2771-2
- Orange  
2771-2A
- Red  
2771-2R
- Green  
2771-2V



**Stainless steel instrument cassettes**

MINI  
182x72x34 mm

complete with silicone insert frame  
for 5 instruments

- Blue  
2772-1
- Orange  
2772-1A
- Red  
2772-1R
- Green  
2772-1V

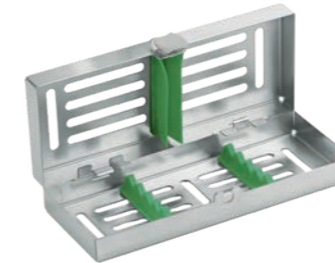

silicone instrument holder  
for 10 places

- Blue  
2770-G
- Orange  
2770-GA
- Red  
2770-GR
- Green  
2770-GV



silicone instrument holder  
for 5 places

- Blue  
2771-G
- Orange  
2771-GA
- Red  
2771-GR
- Green  
2771-GV



silicone insert frame  
for 10 places

- Blue  
2772-G
- Orange  
2772-GA
- Red  
2772-GR
- Green  
2772-GV



silicone insert frame  
for 5 places

- Blue  
2773-G
- Orange  
2773-GA
- Red  
2773-GR
- Green  
2773-GV



set of 2 spare stainless steel  
knobs complete of washers



2774

#2 clips for locking trays  
for scissors

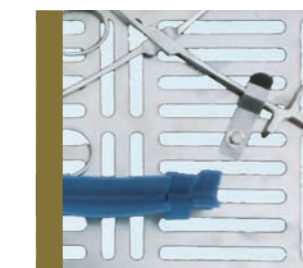

2775

**Stainless steel instrument trays**

LARGE  
288x187x39 mm

instrument tray complete with perforated base, perforated lid and insert frame

**for 16 instruments**  
S2722-1

perforated instrument tray complete with insert frame

**for 23 instruments**  
S2722-2

288x187x29 mm  
perforated lid  
2721-U

284x183x17 mm  
perforated base  
2721-L



**Stainless steel instrument trays**

LARGE  
288x187x39 mm

instrument tray complete with non-perforated base, non-perforated lid and insert frame

**for 16 instruments**  
S2720-1

non-perforated instrument tray complete with insert frame

**for 23 instruments**  
S2720-2

288x187x29 mm  
non-perforated lid  
2720-U

284x183x17 mm  
non-perforated base  
2720-L



instrument tray complete with perforated base, non-perforated lid and insert frame

**for 16 instruments**  
S2721-1

instrument tray complete with perforated base, non-perforated lid and insert frame

**for 23 instruments**  
S2721-2

288x187x29 mm  
non-perforated lid  
2720-U

284 x 183 x 17 mm  
perforated base  
2721-L



stainless steel insert frame  
**for 16 instruments**  
2730-1

stainless steel insert frame  
**for 23 instruments**  
2730-2

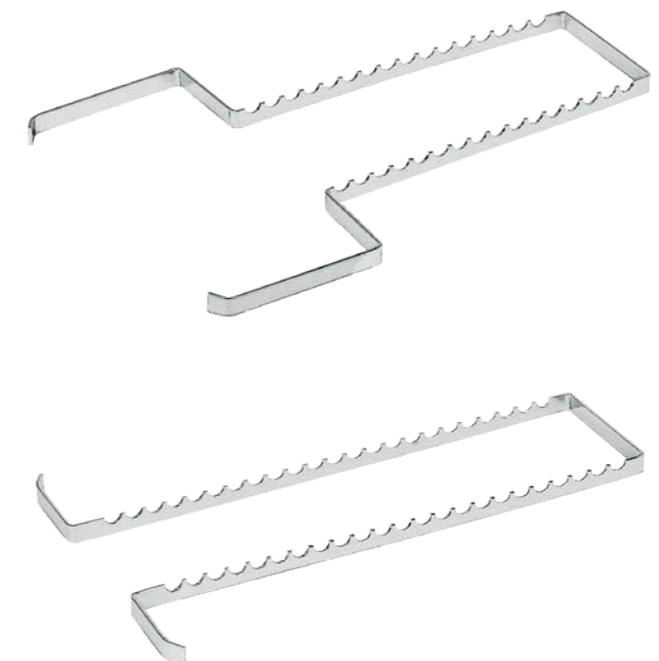

**Stainless steel instrument trays**

MEDIUM  
200x100x30 mm

instrument tray complete with  
perforated base, perforated lid  
and insert frame

**for 7 instruments**  
S2702

200x100x10 mm  
perforated lid  
2702-U

200x100x30 mm  
perforated base  
2702-L

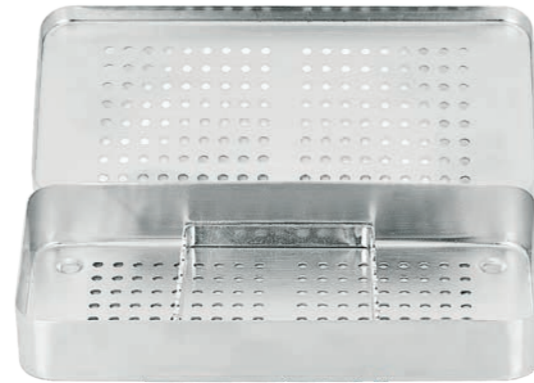

instrument tray complete with  
non-perforated base, non-perforated lid  
and insert frame

**for 7 instruments**  
S2700

200x100x10 mm  
non-perforated lid  
2700-U

200x100x30 mm  
non-perforated base  
2700-L

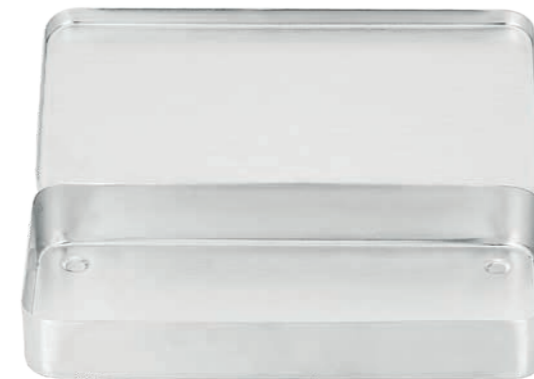

stainless steel insert frame  
**for 7 instruments**  
2700-G



**Stainless steel instrument trays**

MEDIUM  
187x144x39 mm

instrument tray complete with  
perforated base, perforated lid  
and insert frame

**for 8 instruments**  
S2723-1

instrument tray complete with  
perforated base, perforated lid  
and insert frame

**for 4 instruments**  
S2723-2

187x144x29 mm  
perforated lid  
2723-U

183x142x17 mm  
perforated base  
2723-L



instrument tray complete with  
non-perforated base, non-perforated lid  
and insert frame

**for 8 instruments**  
S2724-1

instrument tray complete with  
non-perforated base, lid and insert frame

**for 4 instruments**  
S2724-2

187x144x29 mm  
non-perforated lid  
2724-U

183x142x17 mm  
non-perforated base  
2724-L



stainless steel insert frame  
**for 8 instruments**  
2730-4

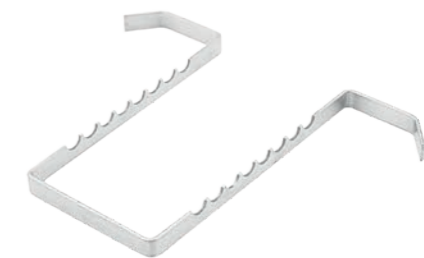

stainless steel insert frame  
**for 4 instruments**  
2730-5

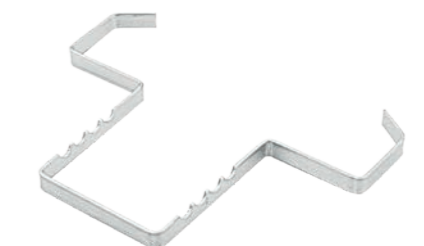

**Aluminum colour-coded instrument trays**

LARGE  
284x183x17 mm

Light blue  
AL2720-LC

Red  
AL2720-LR

Gold  
AL2720-LO

Green  
AL2720-LV

Silver  
AL2720-LA

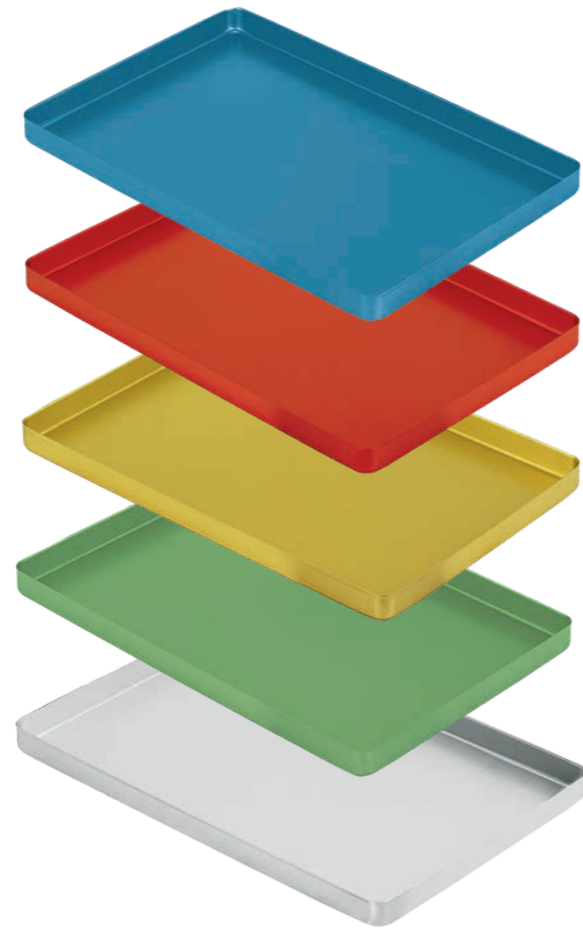

288x187x29 mm  
lid

Silver  
AL2720-UA



**Aluminum insert frames**

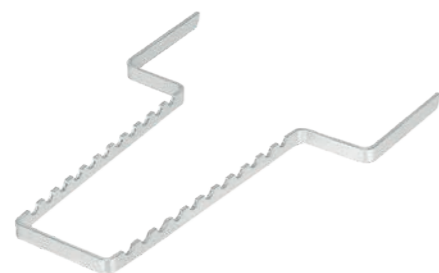

for 11 instruments  
AL2730-1



for 17 instruments  
AL2730-2

**Aluminum colour-coded instrument trays - perforated**

LARGE  
284x183x17 mm

Light blue  
AL2721-LC

Red  
AL2721-LR

Gold  
AL2721-LO

Green  
AL2721-LV

Silver  
AL2721-LA

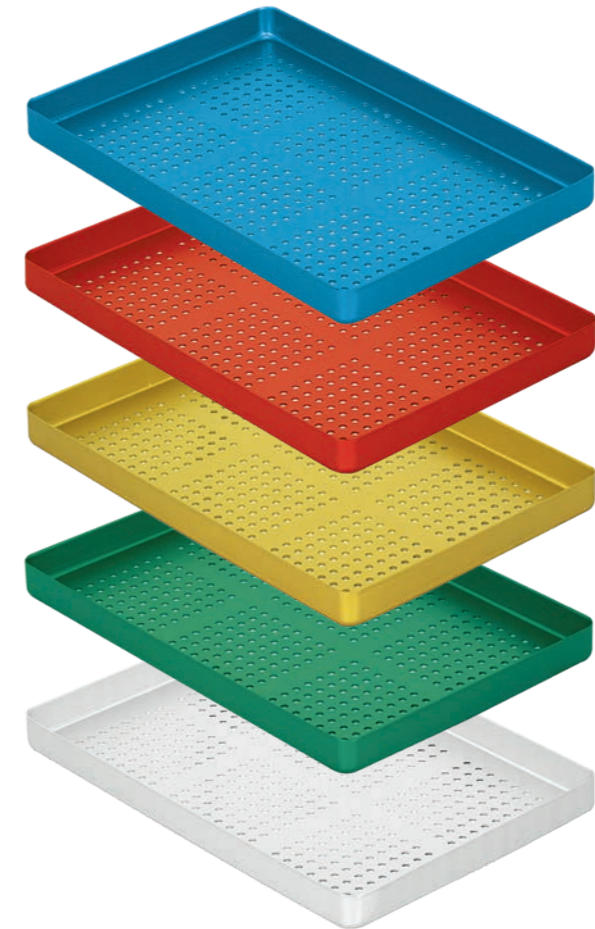

288x187x29 mm  
lid

Silver  
AL2721-UA

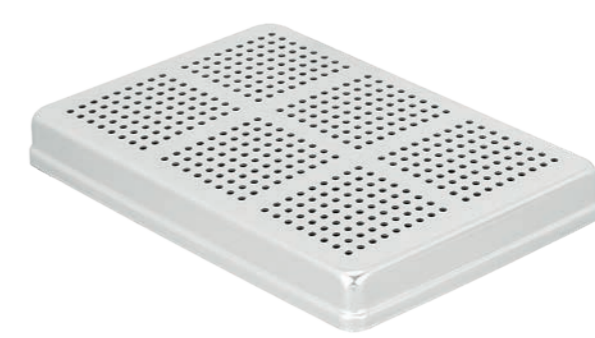

**Aluminum insert frames**



for 10 instruments  
AL2730-3

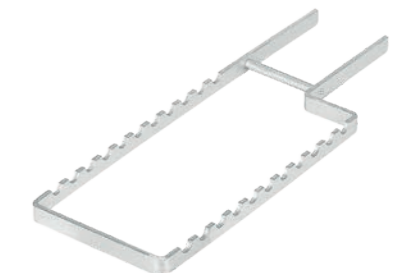

for 11 instruments  
AL2730-4

**Aluminum colour-coded instrument trays**

MEDIUM  
142x183x17 mm

Light blue  
AL2722-LC

Red  
AL2722-LR

Gold  
AL2722-LO

Green  
AL2722-LV

Silver  
AL2722-LA

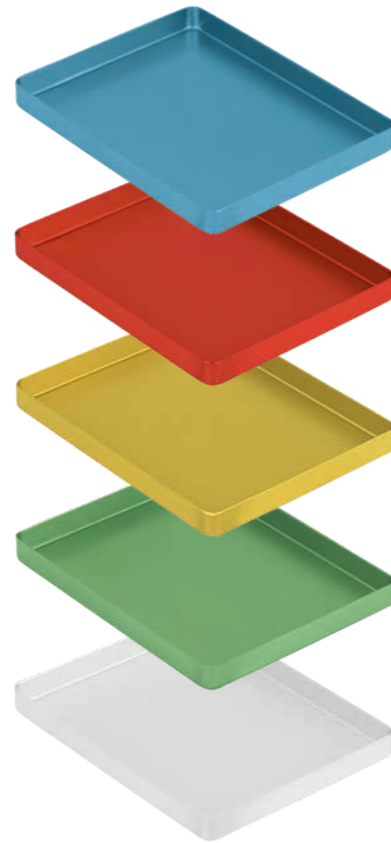

144x187x29 mm  
lid

Silver  
AL2722-UA



**Aluminum colour-coded instrument trays**

MINI  
100x180x11 mm

Light blue  
AL2723-LC

Red  
AL2723-LR

Gold  
AL2723-LO

Green  
AL2723-LV

Silver  
AL2723-LA



103x182x10 mm  
lid

Silver  
AL2723-UA



AL2722-LC  
aluminum instrument trays  
for operating procedures

**Aluminum insert frames**

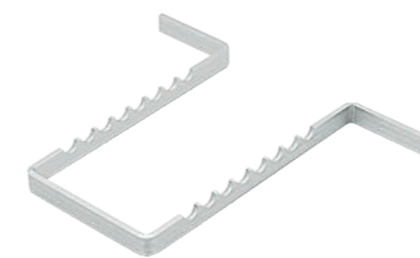

for 8 instruments  
AL2731-1

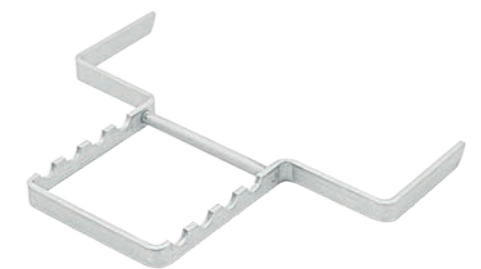

for 4 instruments  
AL2731-2

**Stainless steel trays**

MAXI  
200x150 mm



2737-1



2737-2

kidney trays



2737-3  
170x100x35 mm



2737-4  
250x140x40 mm

**Pliers tray**

stainless steel pliers tray  
STANDARD



S5800

**Autoclave instrument protection lubricant**

Best instruments' autoclaving protection. Penetrates and lubricates all instruments' joints. Protects all dental and surgical hand instruments before and after sterilization. Instructions for use: oil all tips, joints and fastening of instruments before and after sterilization



Steril Oil  
40 ml  
8002

Specific lubricant for dental and surgical instruments. The lubricant is designed to lubricate joints of all dental instruments (scissors, haemostatic and extracting forceps, bone rongeurs, needle holders etc.). Before and after sterilization it does not dry out during sterilization. Provides protection from corrosion and other deposits and ensures proper operation of the instruments



Silicone  
40 ml  
8010

**Aluminum containers for instrument trays**



AL2724-1  
49x26x10 mm



AL2724-2  
49x26x10 mm



AL2724-3  
59x49x10 mm



AL2724-4  
59x49x10 mm

**Aluminum instrument tray rack**

STANDARD  
300x190x270 mm



6 compartments  
AL2739-1

MEDIUM  
160x190x270 mm



6 compartments  
AL2739-2

**Sterilizing forceps**



20 cm  
0565-1



30 cm  
0565-2

**Endodontic boxes**

aluminum endodontic boxes complete with lid

MAXI  
204x105x54 mm



AL2740-1



AL2740-2



AL2740-3

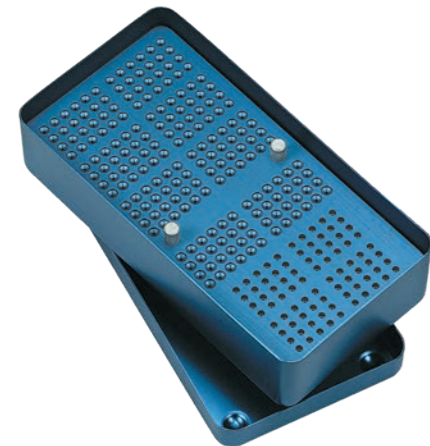

AL2740-4

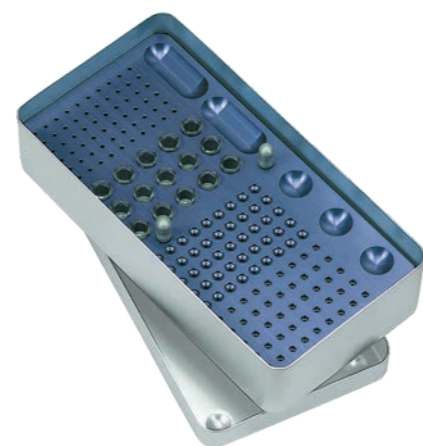

AL2740-5

MEDIUM  
125x105x54 mm



AL2741-1



AL2741-2

spare glasses for endo-box



AL2740-R

**Endodontic boxes**

aluminum endodontic boxes complete with lid

MINI  
100x44x54 mm



AL2742-1



AL2742-2

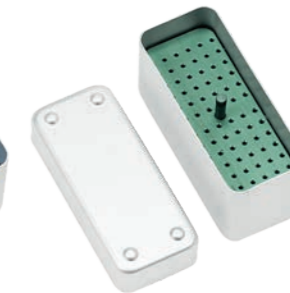

AL2742-3



AL2742-4



AL2742-5



AL2742-6



AL2742-7

round aluminum endodontic boxes  
complete with lid



AL2744  
Ø 48 mm - h. 62 mm



AL2743  
Ø 94 mm - h. 70 mm

spare glasses for endo-box



AL2740-R

**Endodontic articles**

aluminum endodontic tray complete with lid  
257x116x16 mm

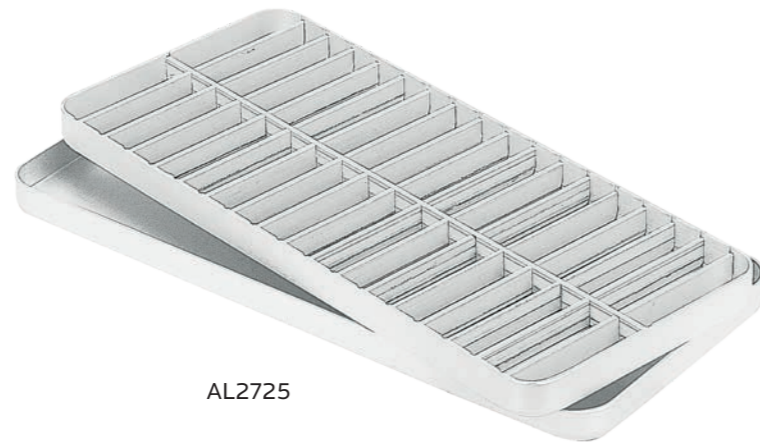

AL2725

aluminum endodontic instrument cleaners  
Ø 40 mm - h. 30 mm



AL2746-1



AL2746-2

aluminum endometers  
100x40x40 mm



AL2747-1A

aluminum endometers  
Ø 34 mm - h. 48 mm



AL2745-1A



AL2745-2C

**Bur holders**



with 7 bur holders  
with lid  
AL2763-1



with 2 bur holders  
AL2763-2

autoclavable  
atoxic food colored silicon  
the plastic cover is not autoclavable

- possibility to insert both turbines' and micromotors' burs, permitting to prepare a unique bur holder which contains all the necessary burs
- possibility to prearrange operative sets by color distinguished (on the market you can find bur holders with not less than 6 different colors), permitting to organize at most warehousing and timing of intervention and choice
- prevention by burs accidental falls due to upsetting of the bur holder, which means prevention by possibility of breaking or sterilize one more time burs, thanks to cross holes that you can find on the best silicon bur holders. AsaFresh is patented by Asa Dental



Orange  
S2760-A



Blue  
S2760-C

aluminum  
suitable for steam sterilizing



with rim, 24 holes FG  
AL2760-1  
(small burs)



with rim, 24 holes CA  
AL2760-2  
(big burs)



with rim, 24 holes FG/CA  
AL2760-3  
(small big burs)



AL2760-U  
lid



with rim, 36 holes FG  
AL2761-1  
(small burs)



with rim, 36 holes CA  
AL2761-2  
(big burs)



with rim, 36 holes FG/CA  
AL2761-3  
(small big burs)



AL2761-U  
lid for AL2761-1, 2, 3  
and for silicon bur holder



48 holes FG  
AL2762-1  
(small burs)



48 holes CA  
AL2762-2  
(big burs)



48 holes FG/CA  
AL2762-3  
(small big burs)

**Accessories**

aluminum waste container  
sterilizable  
available in 5 colours  
Ø 7 x h. 7.5 cm



AL2764-A



AL2764-C



AL2764-O



AL2764-R



AL2764-V

aluminum cotton dispensers with internal spring  
sterilizable  
available in 5 colours  
Ø 7 x h. 7.5 cm



AL2765-A



AL2765-C



AL2765-O



AL2765-R



AL2765-V

disposable waste containers  
1000 pcs / box



AL2767-1

aluminum base  
for waste containers



AL2767-2

**Accessories**

plastic box for used needles



AL2766

stainless steel cotton pellet dispenser  
40x40x50 mm



2751-1

stainless steel  
alcohol burner



3101



spare wick  
15 cm



3101-1

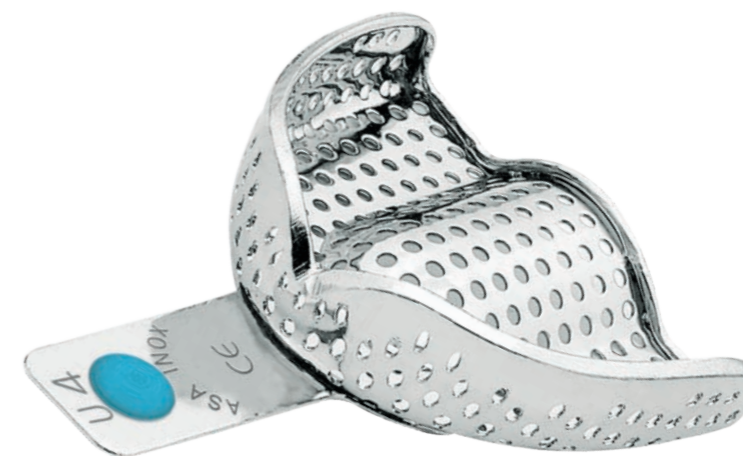

# IMPRESSION TRAYS

MADE IN ITALY

## FIRST IMPRESSION

Many professionals consider impression trays simply as carriers for impression material rather than an important component in the treatment program. Therefore, they under estimate the importance of a correct choice in terms of size, shape, material and dimensional accuracy. Choosing the wrong size or the incorrect shape usually lead to inadequate impression taking: restorations and prosthesis can prove to be ill-fitting, asking for additional time of your work and more costs for your patient. Asa Dental impression trays come in different shapes and materials, with a convenient colour indexing for easy size selection, and all the necessary dimensional accuracy that proves them a key factor for the perfect outcome.

- J4 Perforated, steel
- J20 Non-perforated, steel
- J36 Perforated, aluminum
- J39 For children, aluminum
- J40 Partial occlusal
- J41 For implantology, aluminum
- J42 Polycarbonate

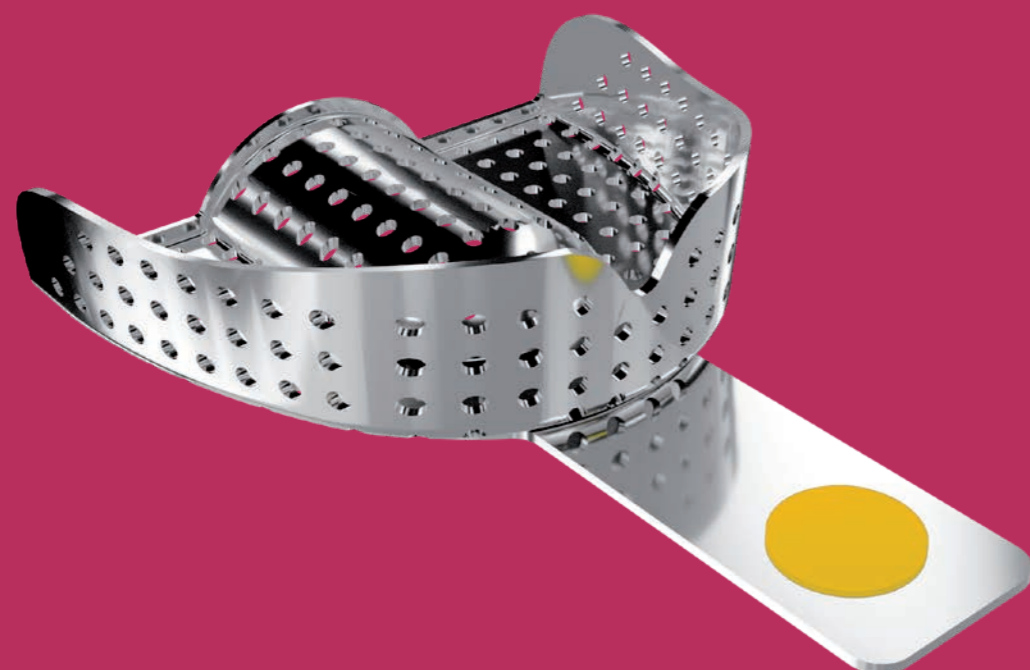

Impression trays parts

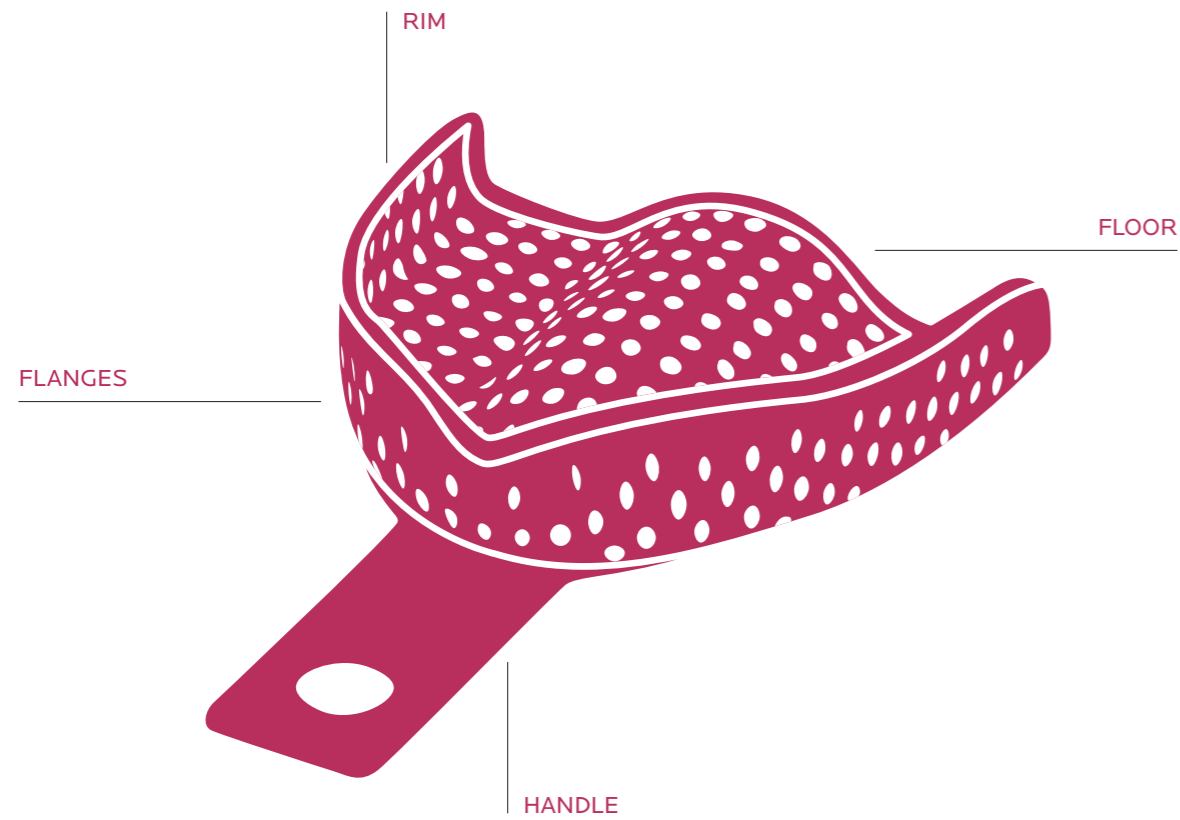

Trays selector

IMPRESSION MATERIALS	IMPRESSION TECHNIQUE					
	Monophase 2 materials	Monophase 1 material	Two-phase	Border molding	Half arch	Sandwich
Silicone	2802 2803 2807	<b>2880</b>	2800 2801 2804 2804S 2808 2809 2811 2813 2814 2806		<b>2819</b>	<b>2819</b> 2803S
Alginate	<b>2804S</b> 2813	<b>2851</b> <b>2852</b> 2804 2801 2800 2814	<b>2806</b> 2851	<b>2851</b>		
Polyether/Polysulfide	<b>2802</b> <b>2803</b> <b>2807</b>	<b>2802</b> <b>2803</b> <b>2803S</b> <b>2807</b> <b>2810</b>				<b>2807S</b> <b>2810</b>

Legenda

**2880**: ideal  
2807: compatible

Color index

ASA Codicolor

- U1/L1**  
XXS
- U2/L2**  
XS
- U3/L3**  
S
- U4/L4**  
M
- U5/L5**  
L
- U6/L6**  
XL



Types of impression trays

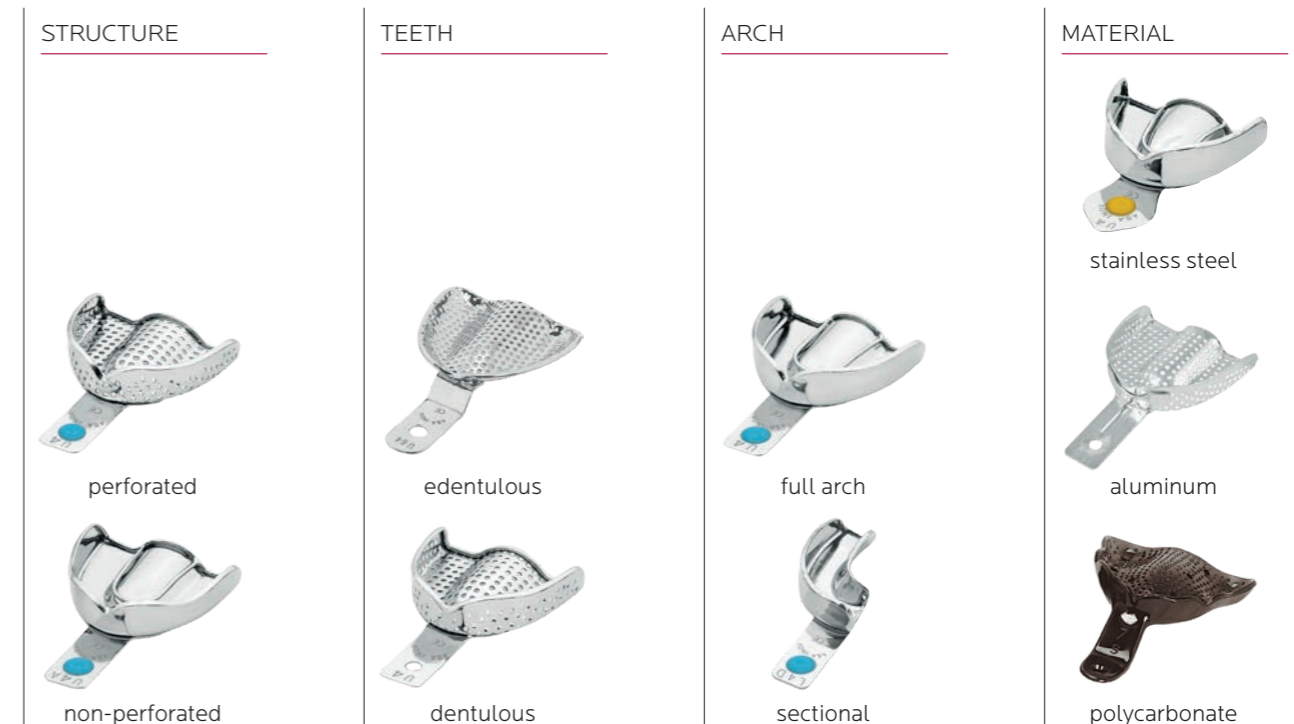

**Perforated stainless steel impression trays - PERMA-LOCK**

with retention rim

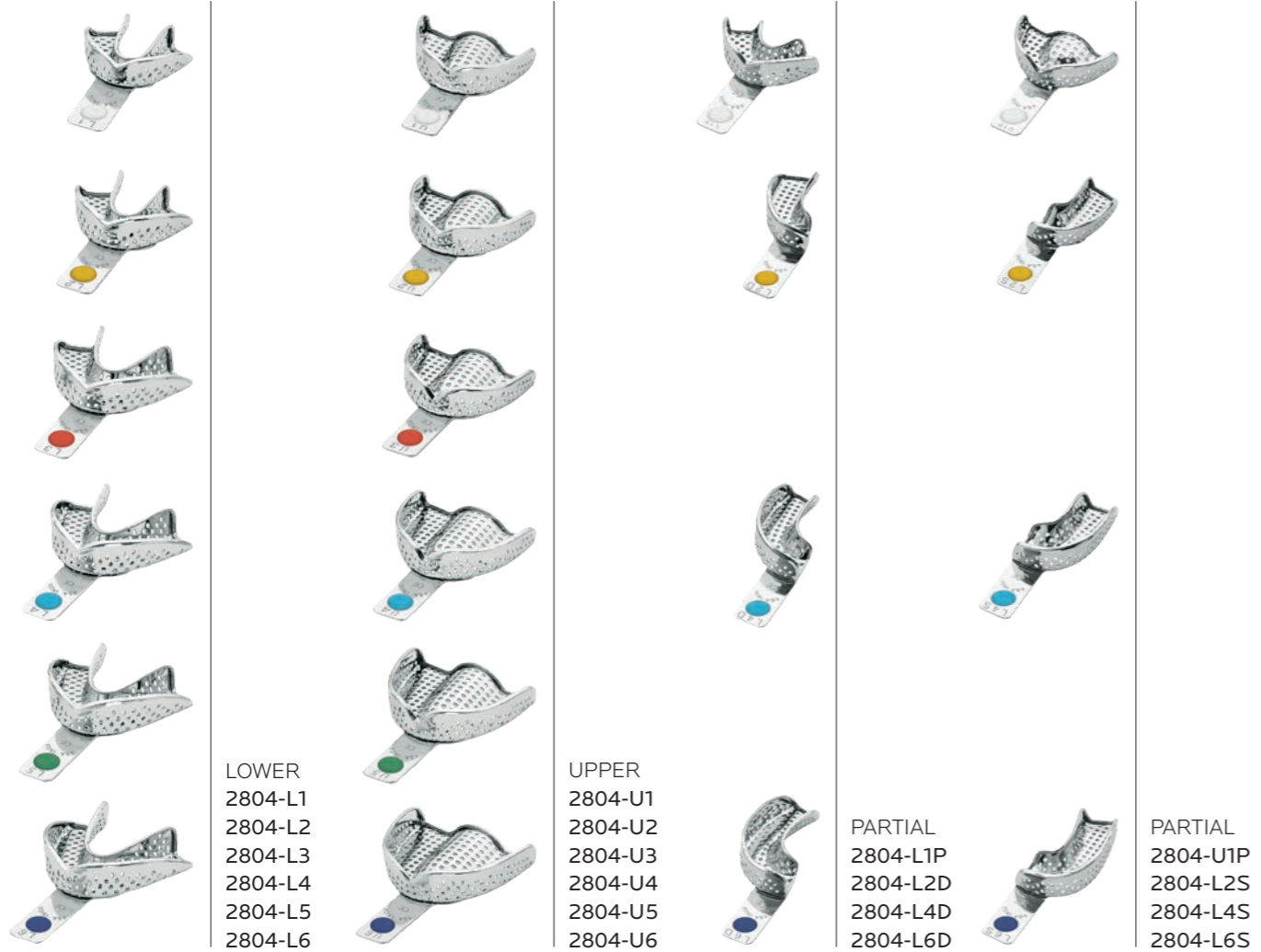

LOWER  
2804-L1  
2804-L2  
2804-L3  
2804-L4  
2804-L5  
2804-L6

UPPER  
2804-U1  
2804-U2  
2804-U3  
2804-U4  
2804-U5  
2804-U6

PARTIAL  
2804-L1P  
2804-L2D  
2804-L4D  
2804-L6D

PARTIAL  
2804-U1P  
2804-L2S  
2804-L4S  
2804-L6S

**Perforated stainless steel impression trays - PERMA-LOCK**

with retention rim

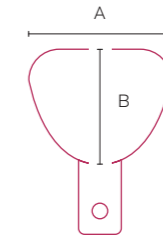
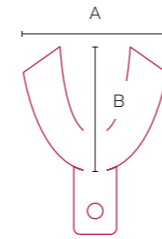

2804 UPPER		A (mm)	B (mm)
U1	XXS	61	47
U2	XS	64	51
U3	S	66	53
U4	M	69	57
U5	L	71	60
U6	XL	73	62

ASA Codicolor

- U1/L1  
XXS
- U2/L2  
XS
- U3/L3  
S
- U4/L4  
M
- U5/L5  
L
- U6/L6  
XL



**Perforated stainless steel impression trays - PERMA-LOCK ANATOMIC**

with retention rim

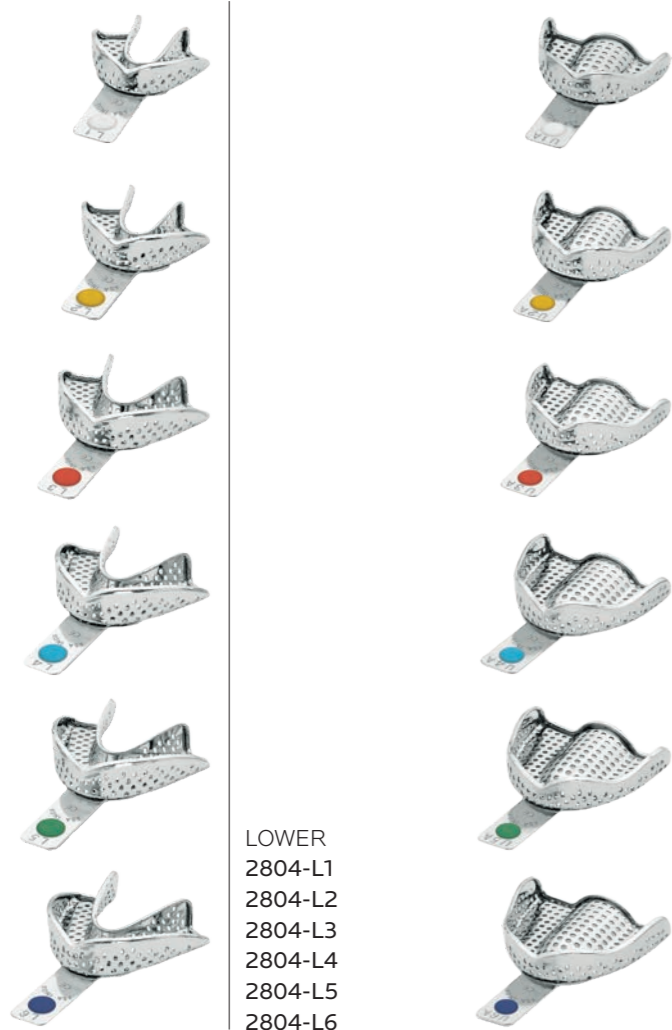

- LOWER
- 2804-L1
- 2804-L2
- 2804-L3
- 2804-L4
- 2804-L5
- 2804-L6



- UPPER
- 2804-U1A
- 2804-U2A
- 2804-U3A
- 2804-U4A
- 2804-U5A
- 2804-U6A

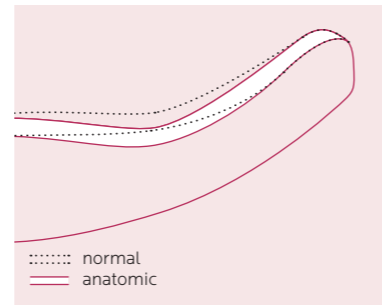

**Perforated stainless steel impression trays - PERMA-LOCK ANATOMIC**

with retention rim

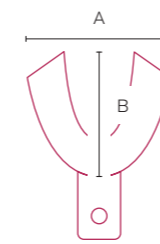

2804 LOWER		A (mm)	B (mm)
L1	XXS	55	47
L2	XS	60	49
L3	S	72	54
L4	M	74	57
L5	L	76	59
L6	XL	78	61

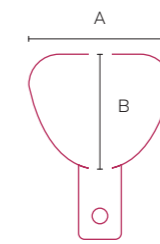

2804A UPPER		A (mm)	B (mm)
U1A	XXS	61	47
U2A	XS	64	51
U3A	S	66	53
U4A	M	69	57
U5A	L	71	60
U6A	XL	73	62



ASA Codicolor

- U1/L1  
XXS
- U2/L2  
XS
- U3/L3  
S
- U4/L4  
M
- U5/L5  
L
- U6/L6  
XL

**Perforated stainless steel impression trays - PERMA-LOCK HIGH GRIP**

with increased retention rim and internal high grip satin finish

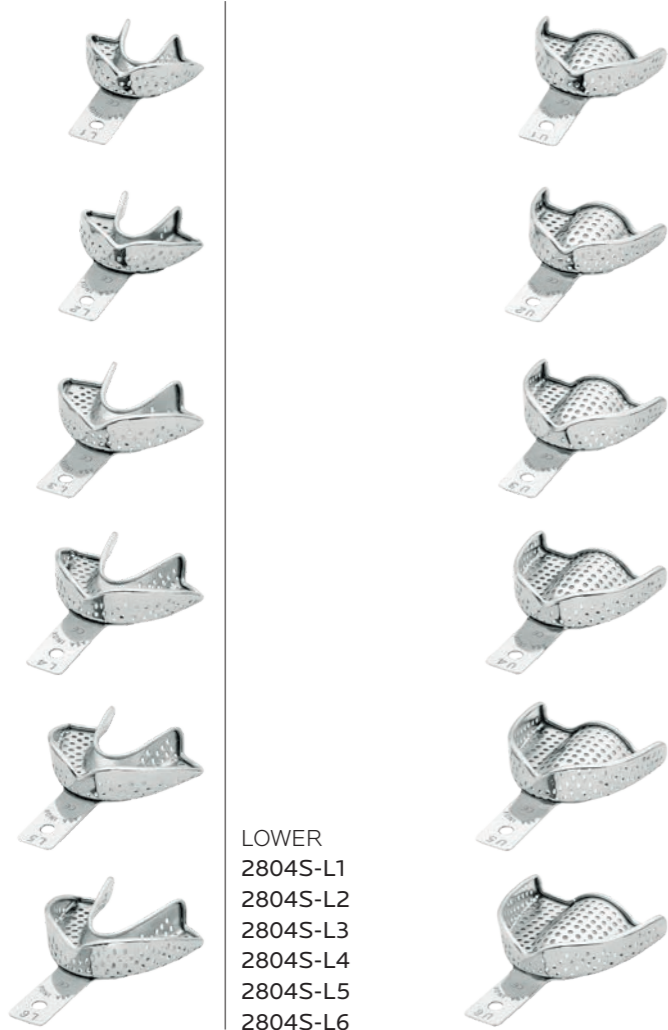

LOWER  
2804S-L1  
2804S-L2  
2804S-L3  
2804S-L4  
2804S-L5  
2804S-L6



UPPER  
2804S-U1  
2804S-U2  
2804S-U3  
2804S-U4  
2804S-U5  
2804S-U6

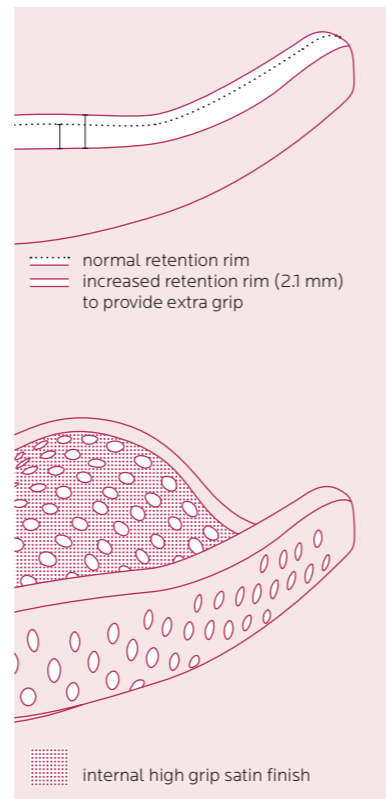

**Perforated stainless steel impression trays - PERMA-LOCK HIGH GRIP**

with increased retention rim and internal high grip satin finish

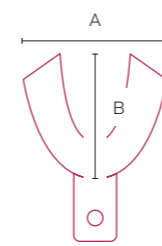

2804S LOWER		A (mm)	B (mm)
L1	XXS	55	47
L2	XS	60	49
L3	S	72	54
L4	M	74	57
L5	L	76	59
L6	XL	78	61

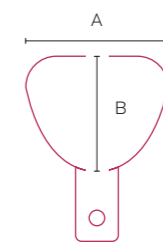

2804S UPPER		A (mm)	B (mm)
U1	XXS	61	47
U2	XS	64	51
U3	S	66	53
U4	M	69	57
U5	L	71	60
U6	XL	73	62

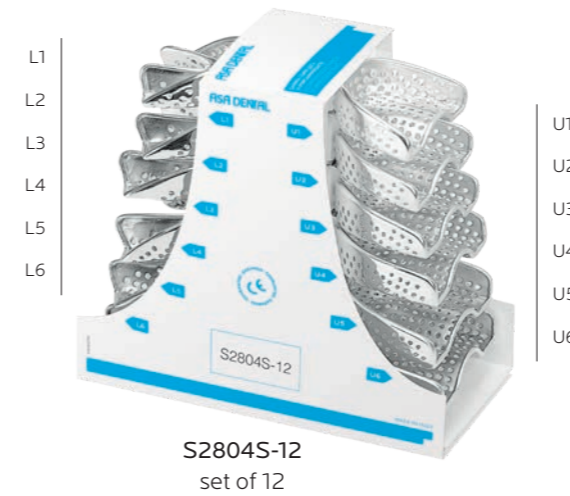

**Perforated stainless steel impression trays - anterior depressed**

with retention rim



LOWER  
2809-L22  
2809-L21  
2809-L20



UPPER  
2809-U7  
2809-U4  
2809-U1

L22  
L21  
L20



S2809-6  
set of 6

U7  
U4  
U1

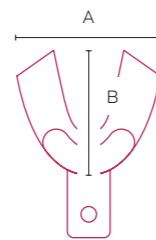

2809 LOWER		A (mm)	B (mm)
L22	S	76	54
L21	M	79	57
L20	L	81	60

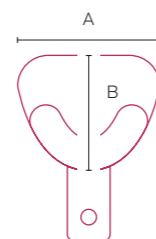

2809 UPPER		A (mm)	B (mm)
U7	S	70	57
U4	M	71	64
U1	L	81	67

**Perforated stainless steel impression trays - edentulous**

with retention rim



LOWER  
2806-L69  
2806-L68  
2806-L67  
2806-L66



UPPER  
2806-U64  
2806-U63  
2806-U62  
2806-U61

L69  
L68  
L67  
L66



S2806-8  
set of 8

U64  
U63  
U62  
U61

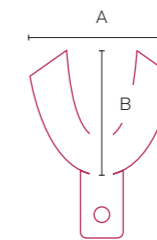

2806 LOWER		A (mm)	B (mm)
L69	S	70	57
L68	M	73	60
L67	NL	70	64
L66	L	86	64

NL: Narrow Large

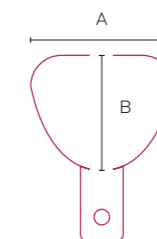

2806 UPPER		A (mm)	B (mm)
U64	S	73	60
U63	NM	70	64
U62	M	76	67
U61	L	79	70

NM: Narrow Medium

**Perforated stainless steel impression trays**

without retention rim

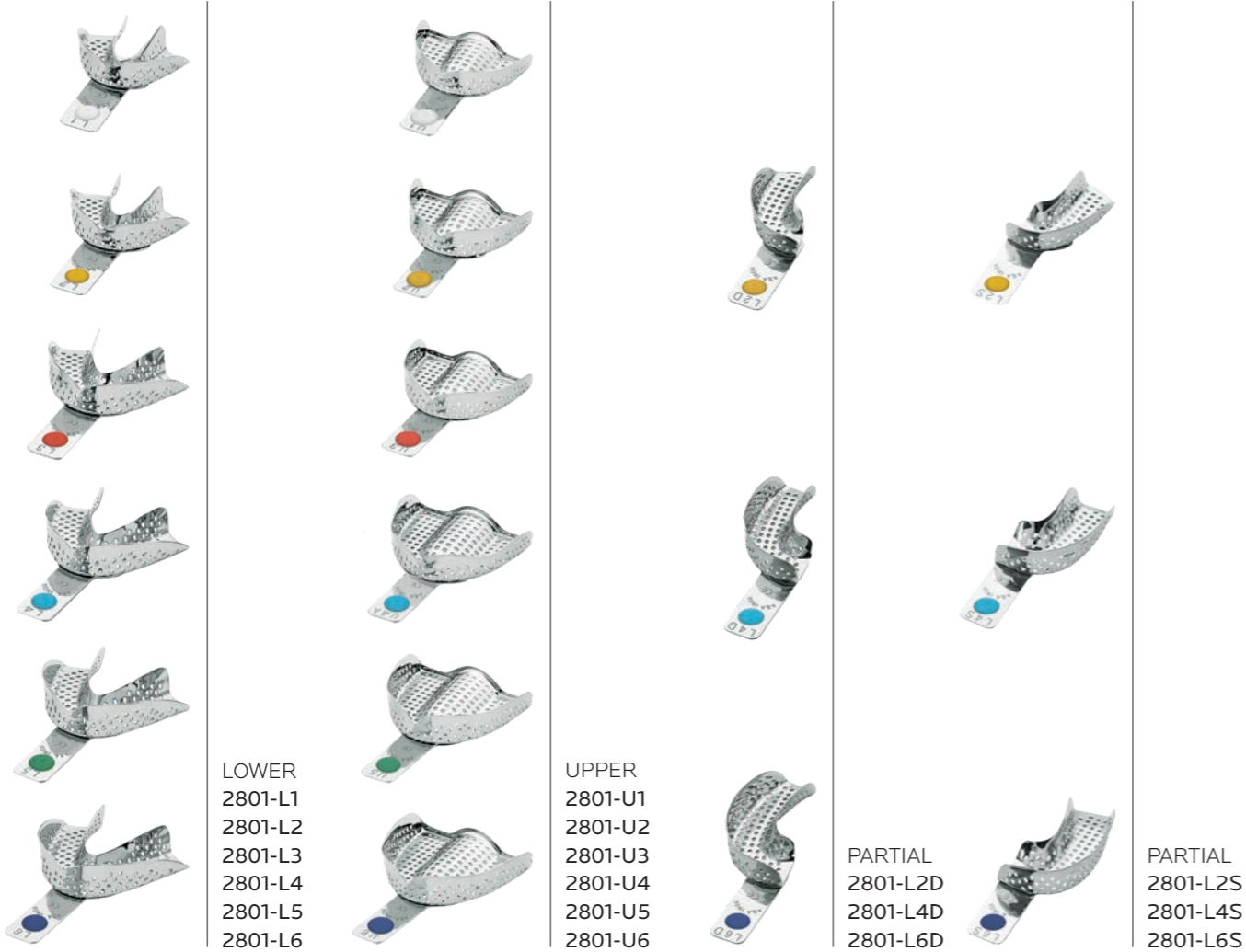
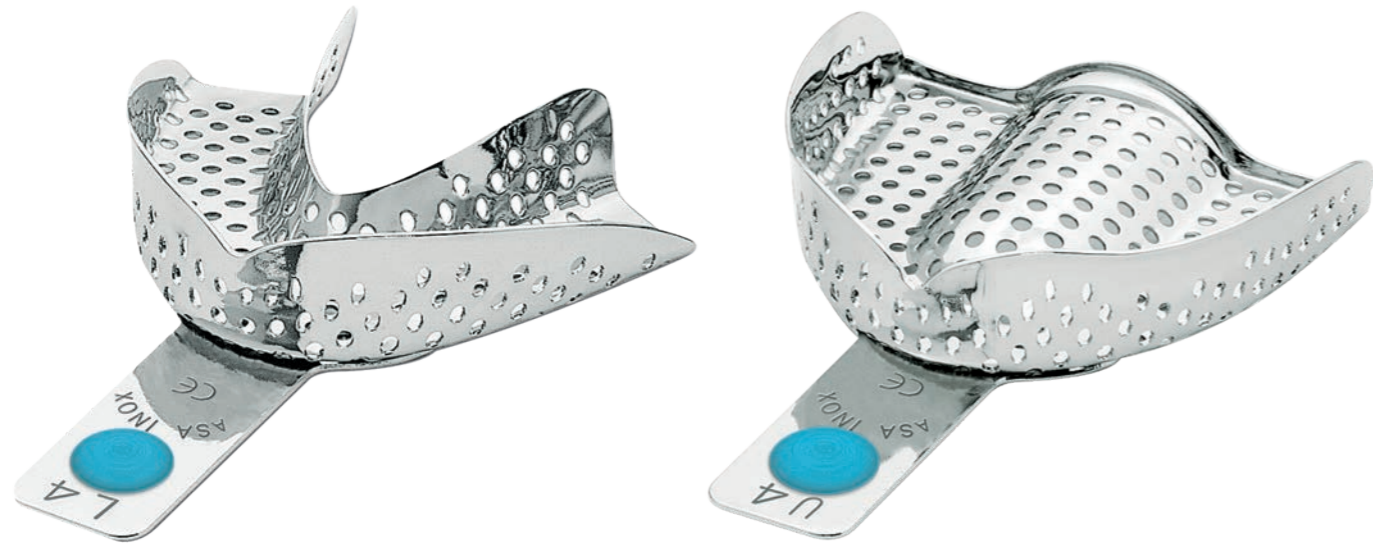

LOWER  
2801-L1  
2801-L2  
2801-L3  
2801-L4  
2801-L5  
2801-L6

UPPER  
2801-U1  
2801-U2  
2801-U3  
2801-U4  
2801-U5  
2801-U6

PARTIAL  
2801-L2D  
2801-L4D  
2801-L6D

PARTIAL  
2801-L2S  
2801-L4S  
2801-L6S

**Perforated stainless steel impression trays**

without retention rim

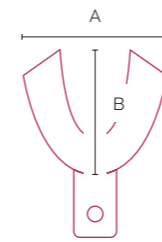

2801 LOWER		A (mm)	B (mm)
L1	XXS	55	47
L2	XS	60	49
L3	S	72	54
L4	M	74	57
L5	L	76	59
L6	XL	78	61

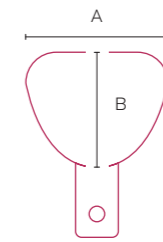

2801 UPPER		A (mm)	B (mm)
U1	XXS	61	47
U2	XS	64	51
U3	S	66	53
U4	M	69	57
U5	L	71	60
U6	XL	73	62



ASA Codicolor

- U1/L1  
XXS
- U2/L2  
XS
- U3/L3  
S
- U4/L4  
M
- U5/L5  
L
- U6/L6  
XL

**Perforated stainless steel impression trays - ANATOMIC**

without retention rim

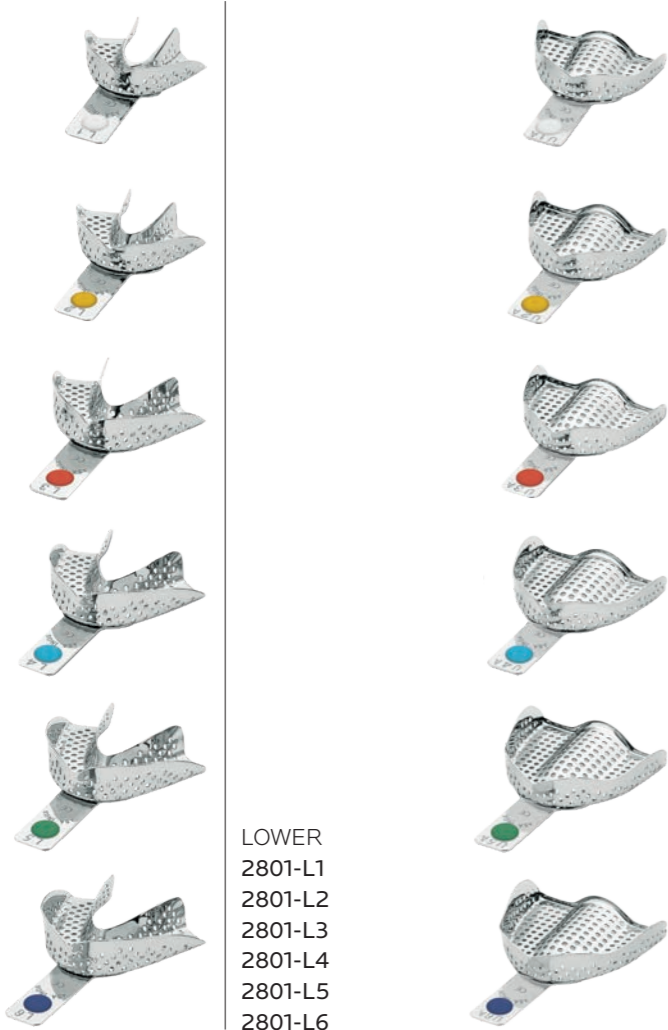
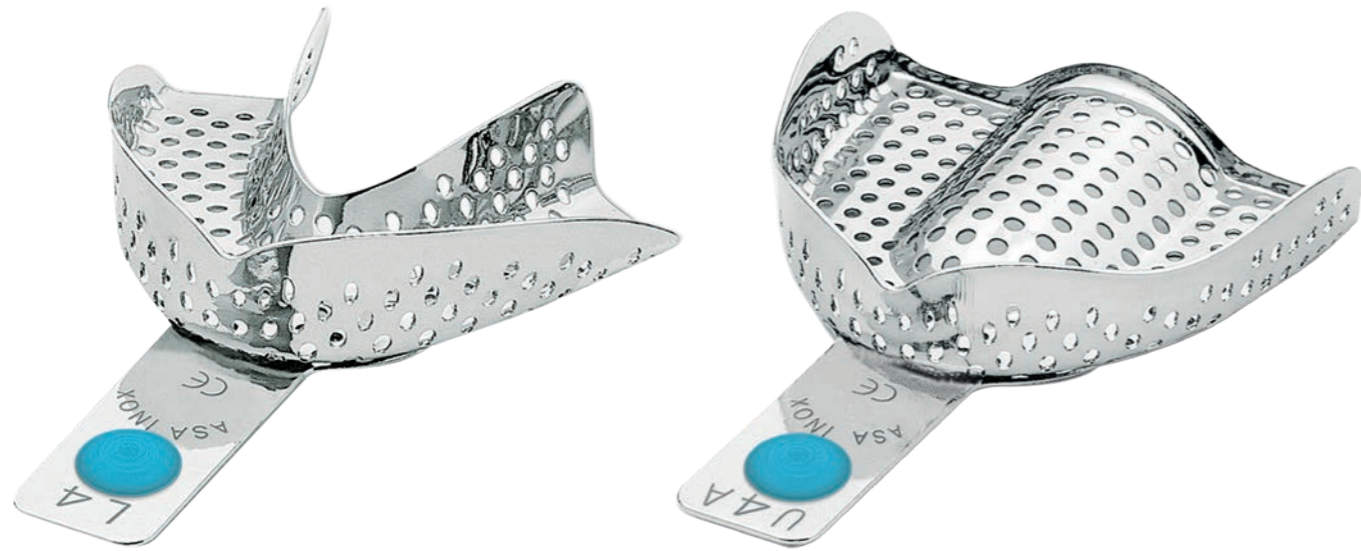

LOWER  
2801-L1  
2801-L2  
2801-L3  
2801-L4  
2801-L5  
2801-L6



UPPER  
2801-U1A  
2801-U2A  
2801-U3A  
2801-U4A  
2801-U5A  
2801-U6A

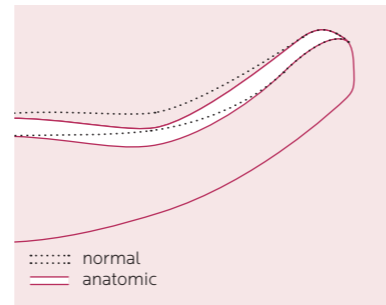

**Perforated stainless steel impression trays - ANATOMIC**

without retention rim

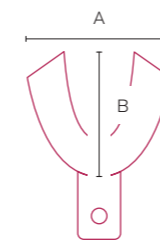

2801 LOWER		A (mm)	B (mm)
L1	XXS	55	47
L2	XS	60	49
L3	S	72	54
L4	M	74	57
L5	L	76	59
L6	XL	78	61

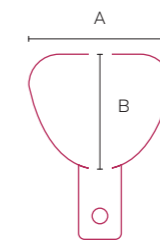

2801A UPPER		A (mm)	B (mm)
U1	XXS	61	47
U2	XS	64	51
U3	S	66	53
U4	M	69	57
U5	L	71	60
U6	XL	73	62



S2801A-12  
set of 12



S2801A-8  
set of 8



S2801A-6  
set of 6

ASA Codicolor

- U1/L1  
XXS
- U2/L2  
XS
- U3/L3  
S
- U4/L4  
M
- U5/L5  
L
- U6/L6  
XL

**Perforated stainless steel impression trays - Ehrlicke**

without retention rim

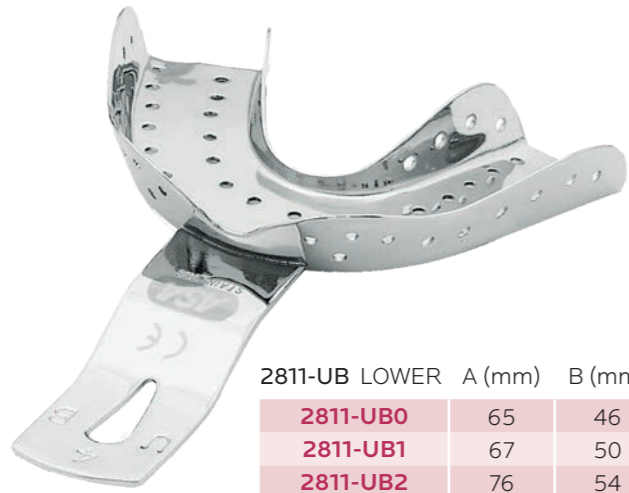
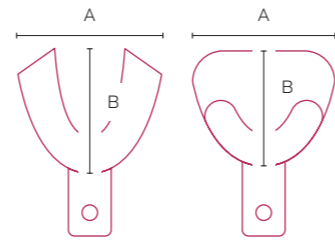

2811-UB LOWER	A (mm)	B (mm)
<b>2811-UB0</b>	65	46
<b>2811-UB1</b>	67	50
<b>2811-UB2</b>	76	54
<b>2811-UB3</b>	79	56
<b>2811-UB4</b>	79	61

for lower jaws, for children



2811-OB UPPER	A (mm)	B (mm)
<b>2811-OB0</b>	59	52
<b>2811-OB1</b>	66	52
<b>2811-OB2</b>	71	62
<b>2811-OB3</b>	71	64
<b>2811-OB4</b>	80	70

for upper jaws, for children



2811-BS UPPER	A (mm)	B (mm)
<b>2811-BS2</b>	70	54

for narrow upper jaws

**Perforated stainless steel impression trays - Ehrlicke**

without retention rim

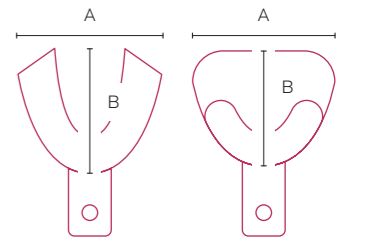

2811-UU LOWER	A (mm)	B (mm)
<b>2811-UU1</b>	70	48
<b>2811-UU2</b>	70	53
<b>2811-UU3</b>	72	57

for edentulous lower jaws



2811-OU UPPER	A (mm)	B (mm)
<b>2811-OU1</b>	64	46
<b>2811-OU2</b>	68	53
<b>2811-OU3</b>	79	61

for edentulous upper jaws



2811-UP LOWER	A (mm)	B (mm)
<b>2811-UP1</b>	70	55
<b>2811-UP2</b>	78	59

for partially toothed lower jaws



2811-OP LOWER	A (mm)	B (mm)
<b>2811-OP1</b>	62	50
<b>2811-OP2</b>	70	56

for partially toothed upper jaws



S2811-1  
set of 10

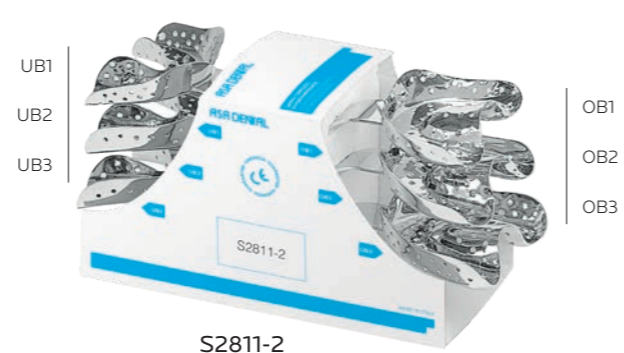

S2811-2  
set of 6



S2811-3  
set of 10

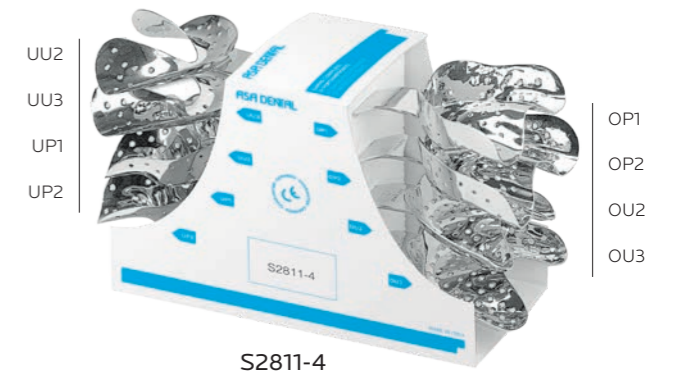

S2811-4  
set of 8

**Perforated stainless steel impression trays - edentulous**

without retention rim



**Perforated stainless steel impression trays - edentulous**

without retention rim

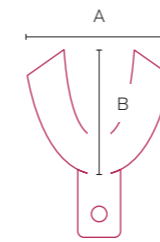

2813 LOWER		A (mm)	B (mm)
L1	XXS	60	54
L2	XS	67	55
L3	S	70	56
L4	M	74	58
L5	L	76	60
L6	XL	80	62

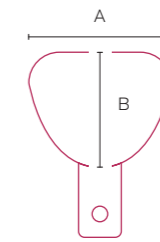

2813 UPPER		A (mm)	B (mm)
U1	XXS	60	50
U2	XS	64	54
U3	S	68	58
U4	M	70	60
U5	L	78	64



LOWER  
2813-L1  
2813-L2  
2813-L3  
2813-L4  
2813-L5  
2813-L6



UPPER  
2813-U1  
2813-U2  
2813-U3  
2813-U4  
2813-U5

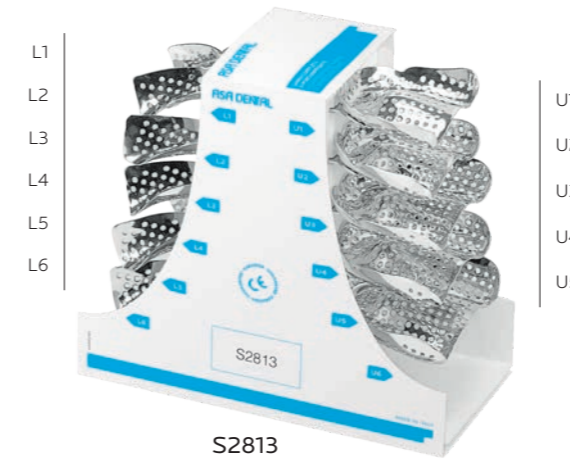

S2813  
set of 11 and compass  
for final impressions



MB026-1  
stainless steel compass

**Non-perforated stainless steel impression trays - NEW SUPER**

with retention rim



**Non-perforated stainless steel impression trays - NEW SUPER**

with retention rim

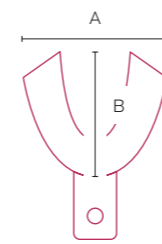



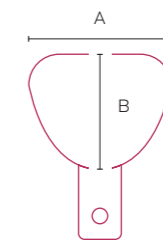

2803 LOWER		A (mm)	B (mm)
L5	XS	69	50
L4	S	72	57
L3	M	76	57
L2	L	78	59
L1	XL	80	63



2803 UPPER		A (mm)	B (mm)
U5	XS	65	51
U4	S	67	53
U3	M	71	55
U2	L	74	60
U1	XL	81	63

ASA Codicolor

-  U5/L5 XS
-  U4/L4 S
-  U3/L3 M
-  U2/L2 L
-  U1/L1 XL



- LOWER
- 2803-L5
- 2803-L4
- 2803-L3
- 2803-L2
- 2803-L1



- UPPER
- 2803-U5
- 2803-U4
- 2803-U3
- 2803-U2
- 2803-U1

**Non-perforated stainless steel impression trays - PERMA-LOCK**

with retention rim

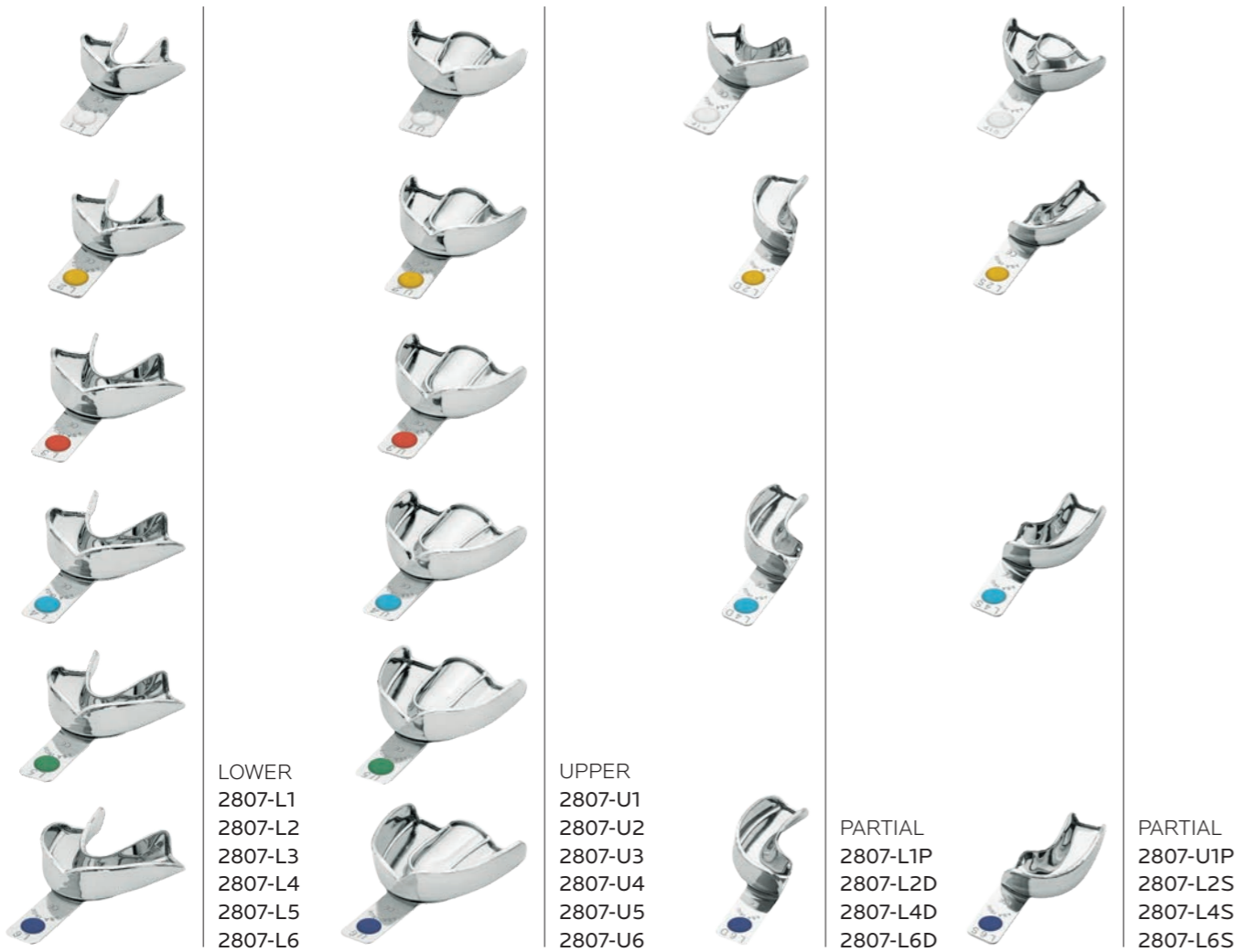

LOWER  
2807-L1  
2807-L2  
2807-L3  
2807-L4  
2807-L5  
2807-L6

UPPER  
2807-U1  
2807-U2  
2807-U3  
2807-U4  
2807-U5  
2807-U6

PARTIAL  
2807-L1P  
2807-L2D  
2807-L4D  
2807-L6D

PARTIAL  
2807-U1P  
2807-L2S  
2807-L4S  
2807-L6S

**Non-perforated stainless steel impression trays - PERMA-LOCK**

with retention rim

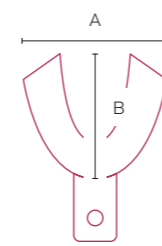

2807 LOWER		A (mm)	B (mm)
L1	XXS	55	47
L2	XS	60	49
L3	S	72	54
L4	M	74	57
L5	L	76	59
L6	XL	78	61

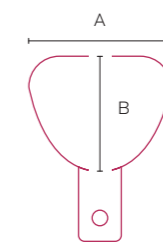

2807 UPPER		A (mm)	B (mm)
U1	XXS	61	47
U2	XS	64	51
U3	S	66	53
U4	M	69	57
U5	L	71	60
U6	XL	73	62



ASA Codicolor

- U1/L1  
XXS
- U2/L2  
XS
- U3/L3  
S
- U4/L4  
M
- U5/L5  
L
- U6/L6  
XL

**Non-perforated stainless steel impression trays - PERMA-LOCK ANATOMIC**

with retention rim

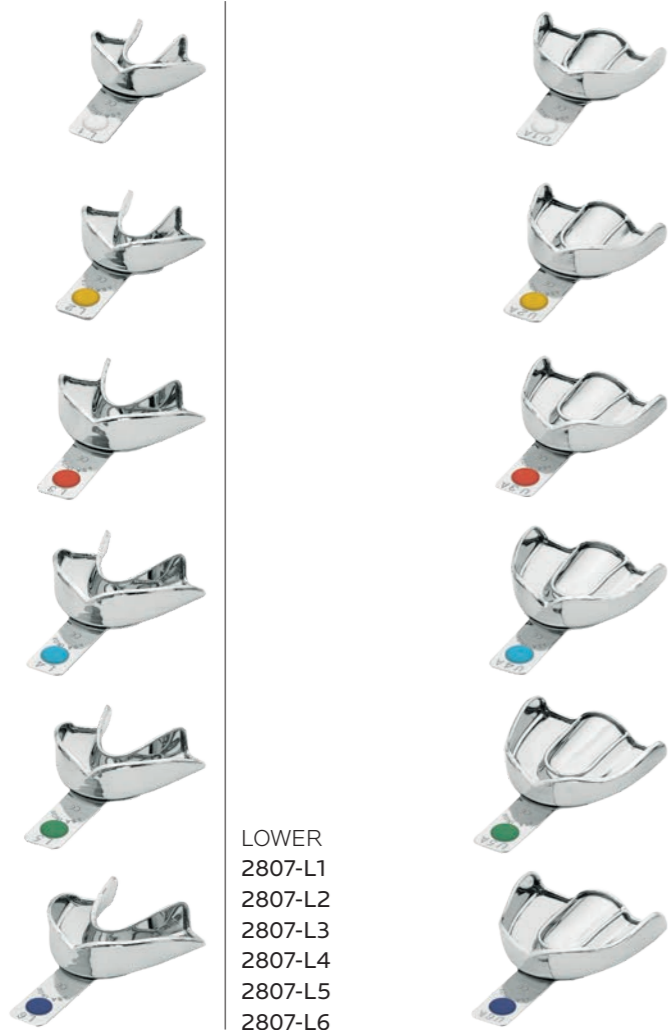

LOWER  
2807-L1  
2807-L2  
2807-L3  
2807-L4  
2807-L5  
2807-L6



UPPER  
2807-U1A  
2807-U2A  
2807-U3A  
2807-U4A  
2807-U5A  
2807-U6A

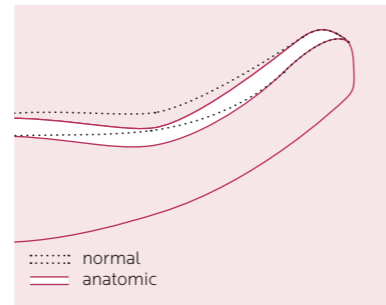

**Non-perforated stainless steel impression trays - PERMA-LOCK ANATOMIC**

with retention rim

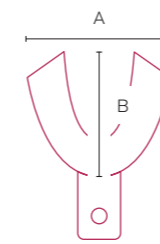

2807 LOWER		A (mm)	B (mm)
L1	XXS	55	47
L2	XS	60	49
L3	S	72	54
L4	M	74	57
L5	L	76	59
L6	XL	78	61

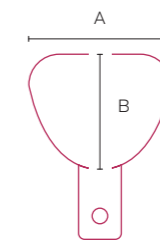

2807A UPPER		A (mm)	B (mm)
U1A	XXS	61	47
U2A	XS	64	51
U3A	S	66	53
U4A	M	69	57
U5A	L	71	60
U6A	XL	73	62



S2807A-12  
set of 12



S2807A-8  
set of 8



S2807A-6  
set of 6

ASA Codicolor

- U1/L1  
XXS
- U2/L2  
XS
- U3/L3  
S
- U4/L4  
M
- U5/L5  
L
- U6/L6  
XL

**Non-perforated stainless steel impression trays - PERMA-LOCK HIGH GRIP**

with increased retention rim and internal high grip satin finish

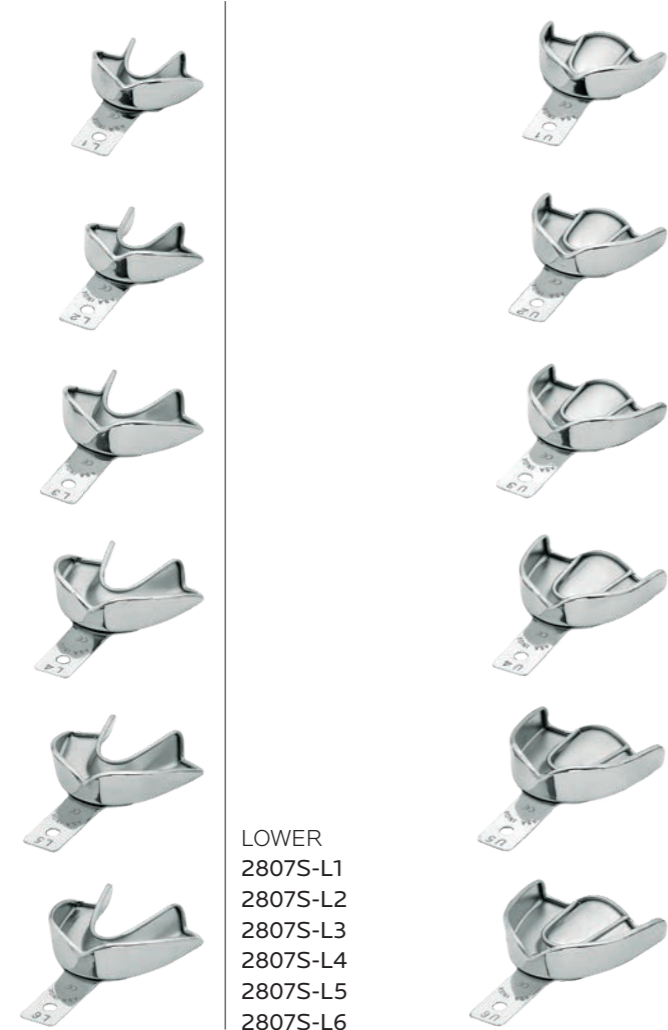

LOWER  
2807S-L1  
2807S-L2  
2807S-L3  
2807S-L4  
2807S-L5  
2807S-L6



UPPER  
2807S-U1  
2807S-U2  
2807S-U3  
2807S-U4  
2807S-U5  
2807S-U6

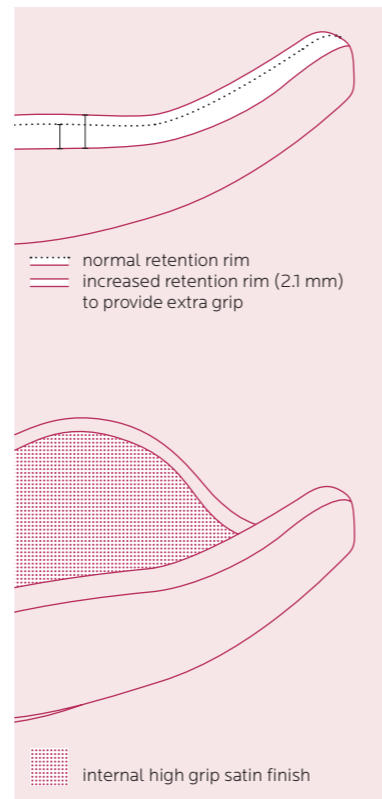

**Non-perforated stainless steel impression trays - PERMA-LOCK HIGH GRIP**

with increased retention rim and internal high grip satin finish

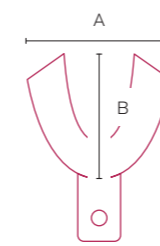

2807S LOWER		A (mm)	B (mm)
L1	XXS	55	47
L2	XS	60	49
L3	S	72	54
L4	M	75	57
L5	L	76	59
L6	XL	78	61

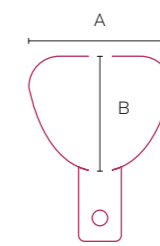

2807S UPPER		A (mm)	B (mm)
U1	XXS	61	47
U2	XS	64	51
U3	S	66	53
U4	M	69	57
U5	L	71	60
U6	XL	73	62



**Non-perforated stainless steel impression trays - anterior depressed**

with retention rim



LOWER  
2810-L22  
2810-L21  
2810-L20



UPPER  
2810-U7  
2810-U4  
2810-U1



S2810-6  
set of 6

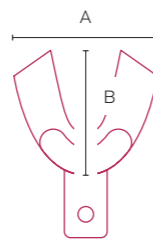

2810 LOWER		A (mm)	B (mm)
<b>L22</b>	S	76	54
<b>L21</b>	M	79	57
<b>L20</b>	L	81	60

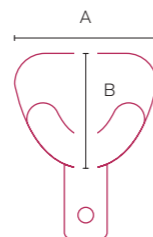

2810 UPPER		A (mm)	B (mm)
<b>U7</b>	S	70	57
<b>U4</b>	M	71	64
<b>U1</b>	L	81	67

**Non-perforated stainless steel impression trays - edentulous**

with retention rim



LOWER  
2808-L69  
2808-L68  
2808-L67  
2808-L66



UPPER  
2808-U64  
2808-U63  
2808-U62  
2808-U61



S2808-8  
set of 8

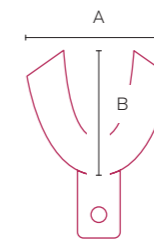

2808 LOWER		A (mm)	B (mm)
<b>L69</b>	S	70	57
<b>L68</b>	M	73	60
<b>L67</b>	NL	70	64
<b>L66</b>	L	86	64

NL: Narrow Large

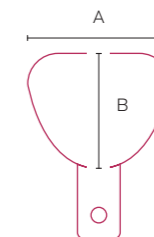

2808 UPPER		A (mm)	B (mm)
<b>U64</b>	S	73	60
<b>U63</b>	NM	70	64
<b>U62</b>	M	76	67
<b>U61</b>	L	79	70

NM: Narrow Medium

**Non-perforated stainless steel impression trays - NEW SUPER HIGH GRIP**

with increased retention rim and internal high grip satin finish



**Non-perforated stainless steel impression trays - NEW SUPER HIGH GRIP**

with increased retention rim and internal high grip satin finish

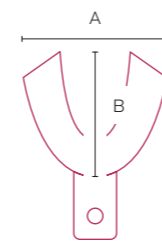

2803S LOWER		A (mm)	B (mm)
<b>L5</b>	XS	69	50
<b>L4</b>	S	72	57
<b>L3</b>	M	76	57
<b>L2</b>	L	78	59
<b>L1</b>	XL	80	63

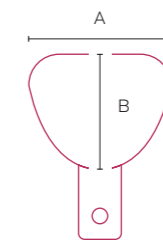

2803S UPPER		A (mm)	B (mm)
<b>U5</b>	XS	65	51
<b>U4</b>	S	67	53
<b>U3</b>	M	71	55
<b>U2</b>	L	74	60
<b>U1</b>	XL	81	63

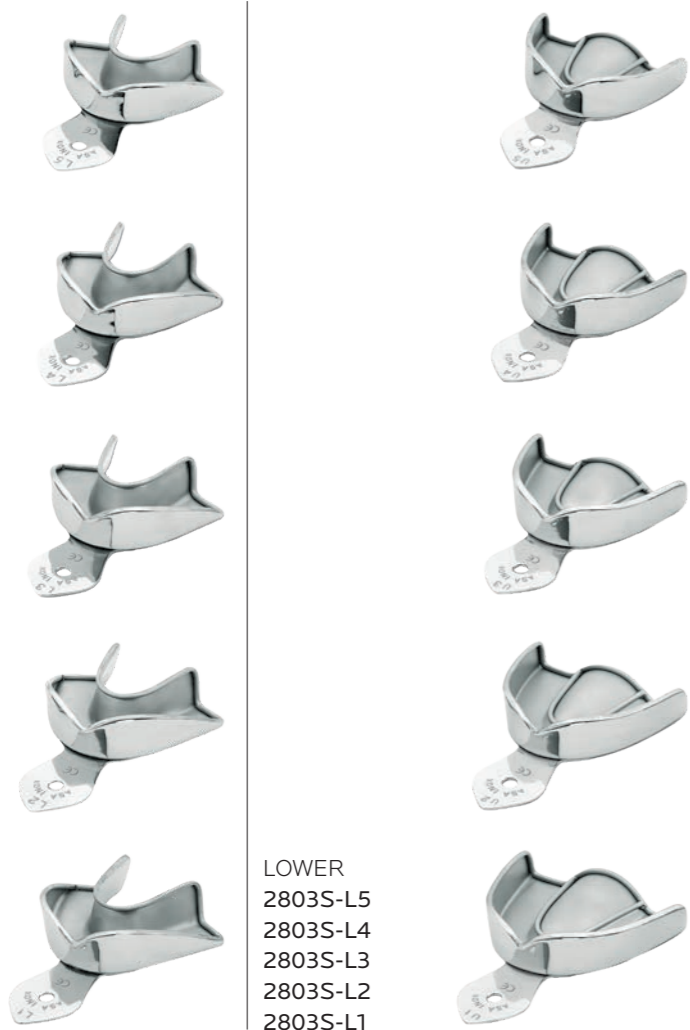

LOWER  
2803S-L5  
2803S-L4  
2803S-L3  
2803S-L2  
2803S-L1

UPPER  
2803S-U5  
2803S-U4  
2803S-U3  
2803S-U2  
2803S-U1

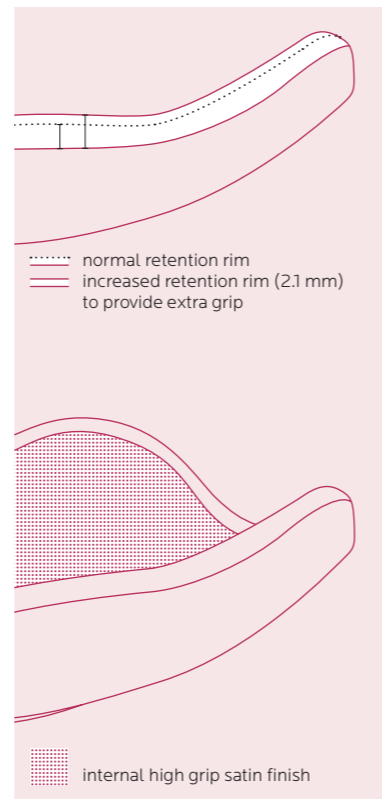

S2803S-10  
set of 10

**Non-perforated stainless steel impression trays**

without retention rim

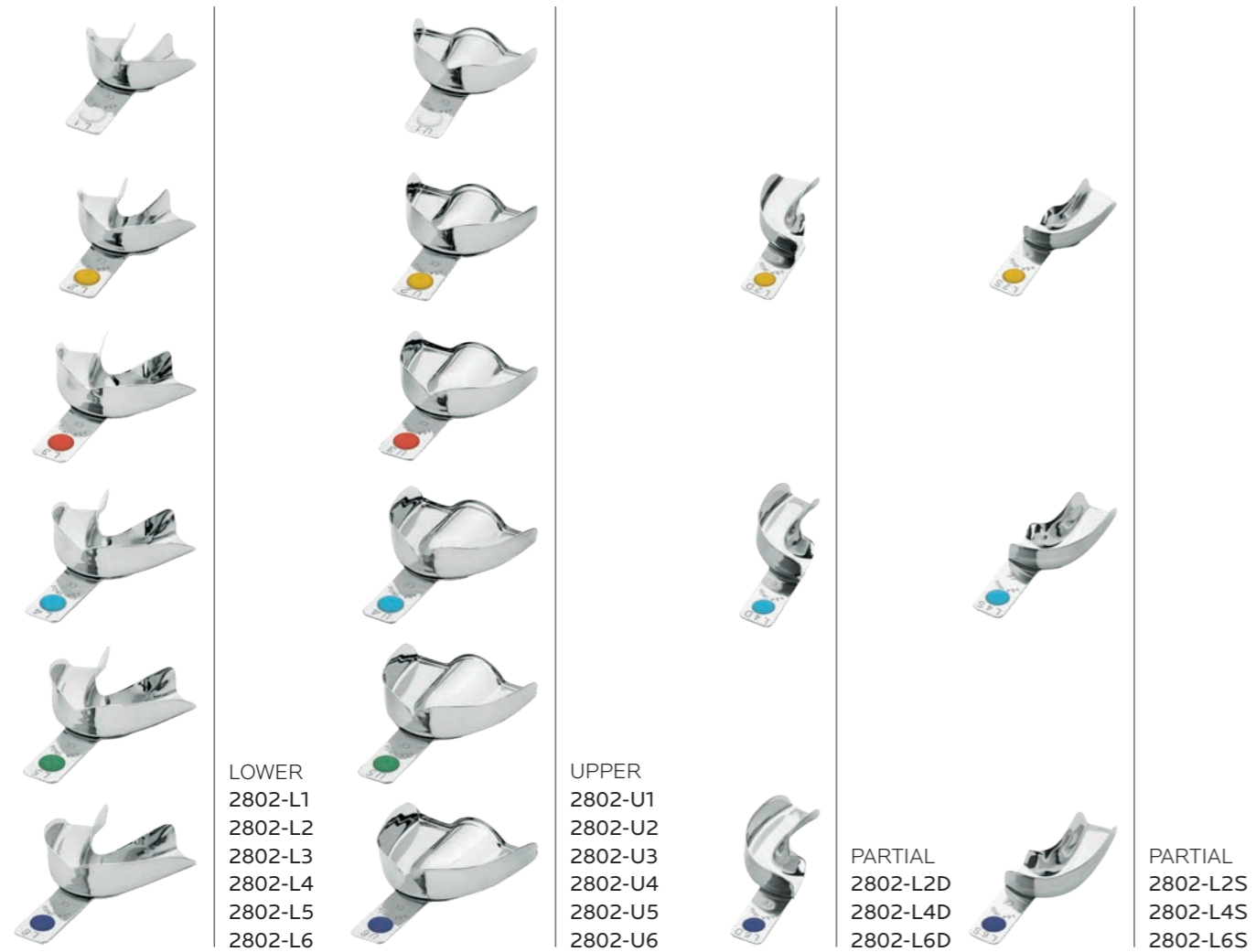

**Non-perforated stainless steel impression trays**

without retention rim

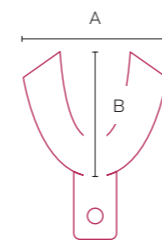

2802 LOWER		A (mm)	B (mm)
L1	XXS	55	47
L2	XS	60	49
L3	S	72	54
L4	M	74	57
L5	L	76	59
L6	XL	78	61

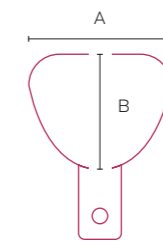

2802 UPPER		A (mm)	B (mm)
U1	XXS	61	47
U2	XS	64	51
U3	S	66	53
U4	M	69	57
U5	L	71	60
U6	XL	73	62



ASA Codicolor

- U1/L1  
XXS
- U2/L2  
XS
- U3/L3  
S
- U4/L4  
M
- U5/L5  
L
- U6/L6  
XL



**Non-perforated stainless steel impression trays - ANATOMIC**

without retention rim

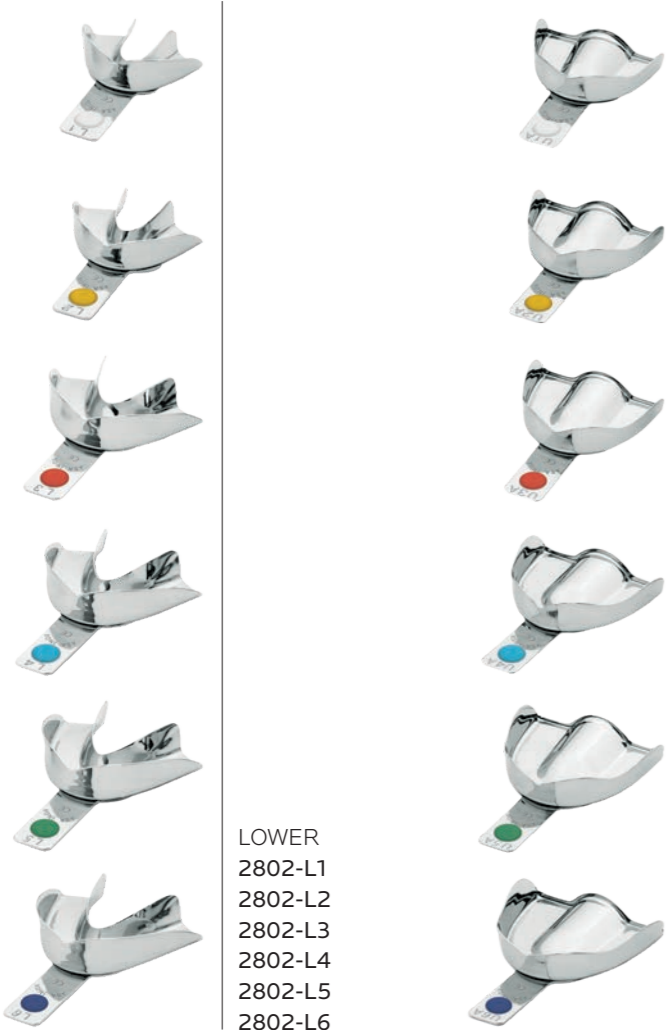

- LOWER
- 2802-L1
- 2802-L2
- 2802-L3
- 2802-L4
- 2802-L5
- 2802-L6



- UPPER
- 2802-U1A
- 2802-U2A
- 2802-U3A
- 2802-U4A
- 2802-U5A
- 2802-U6A

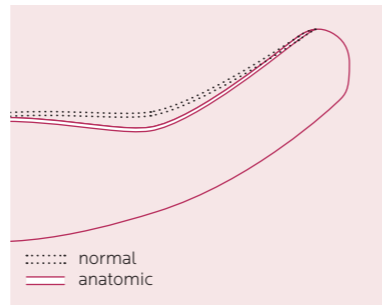

**Non-perforated stainless steel impression trays - ANATOMIC**

without retention rim

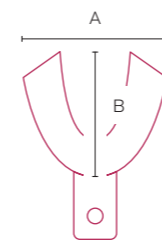

2802 LOWER		A (mm)	B (mm)
L1	XXS	55	47
L2	XS	60	49
L3	S	72	54
L4	M	74	57
L5	L	76	59
L6	XL	78	61

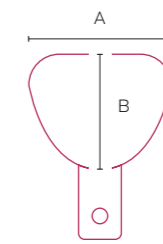

2802A UPPER		A (mm)	B (mm)
U1A	XXS	61	47
U2A	XS	64	51
U3A	S	66	53
U4A	M	69	57
U5A	L	71	60
U6A	XL	73	62



S2802A-12  
set of 12



S2802A-8  
set of 8



S2802A-6  
set of 6

ASA Codicolor

- U1/L1  
XXS
- U2/L2  
XS
- U3/L3  
S
- U4/L4  
M
- U5/L5  
L
- U6/L6  
XL

**Perforated aluminum impression trays**

without retention rim



**Perforated aluminum impression trays**

without retention rim

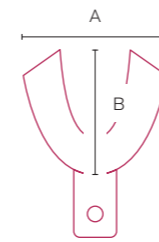

2800 LOWER		A (mm)	B (mm)
L1	XXS	56	48
L2	XS	59	50
L3	S	72	52
L4	M	76	57
L5	L	77	56
L6	XL	78	59

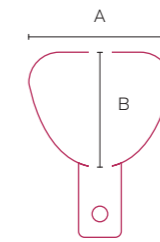

2800 UPPER		A (mm)	B (mm)
U1	XXS	63	48
U2	XS	66	51
U3	S	68	54
U4	M	71	58
U5	L	74	62
U6	XL	76	63

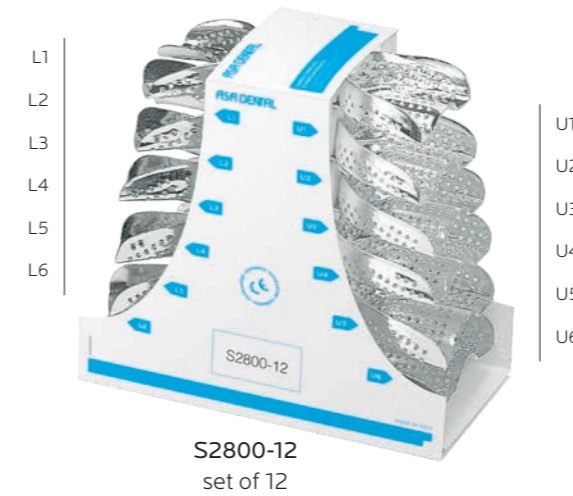
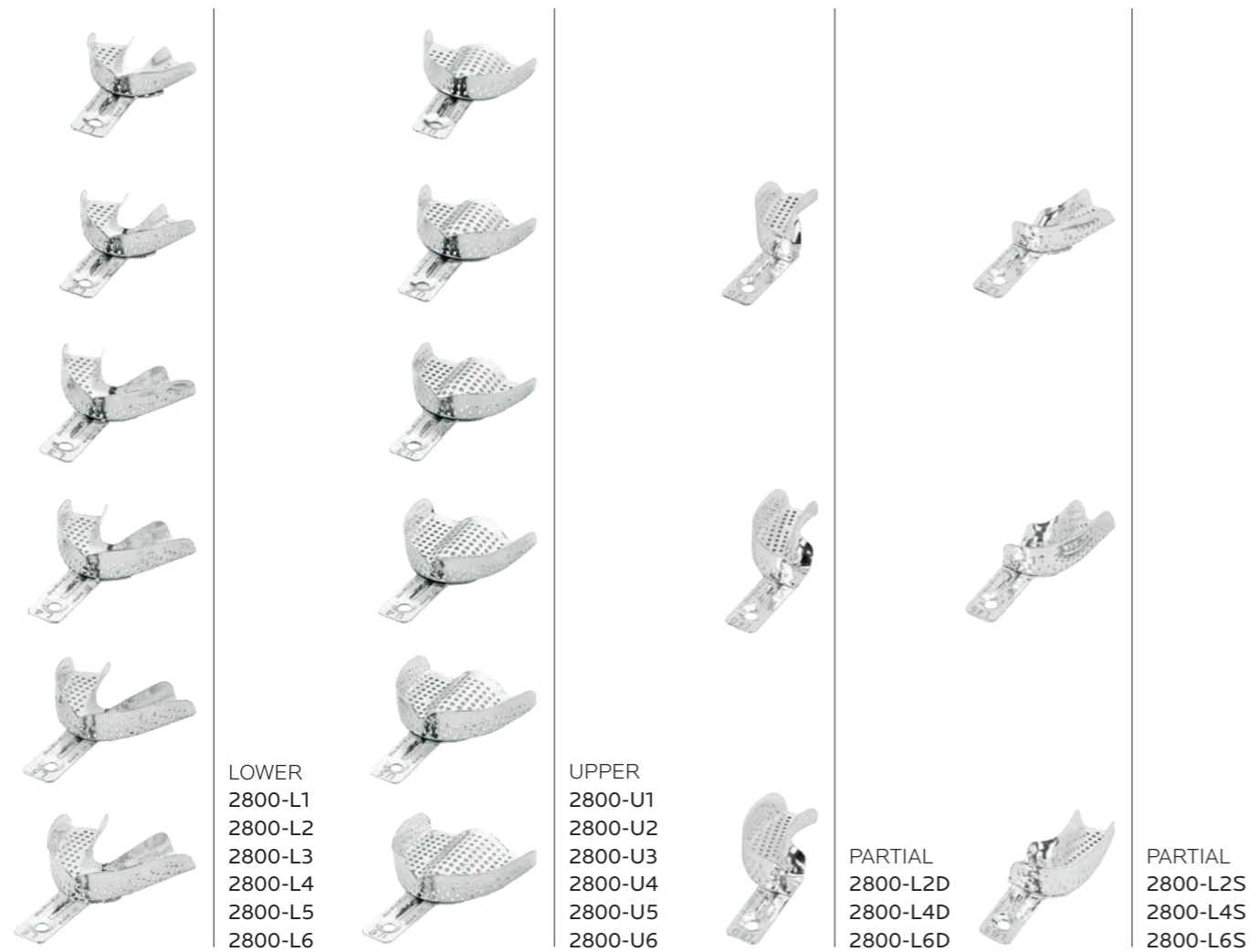

**Perforated aluminum impression trays for implantology**

without retention rim

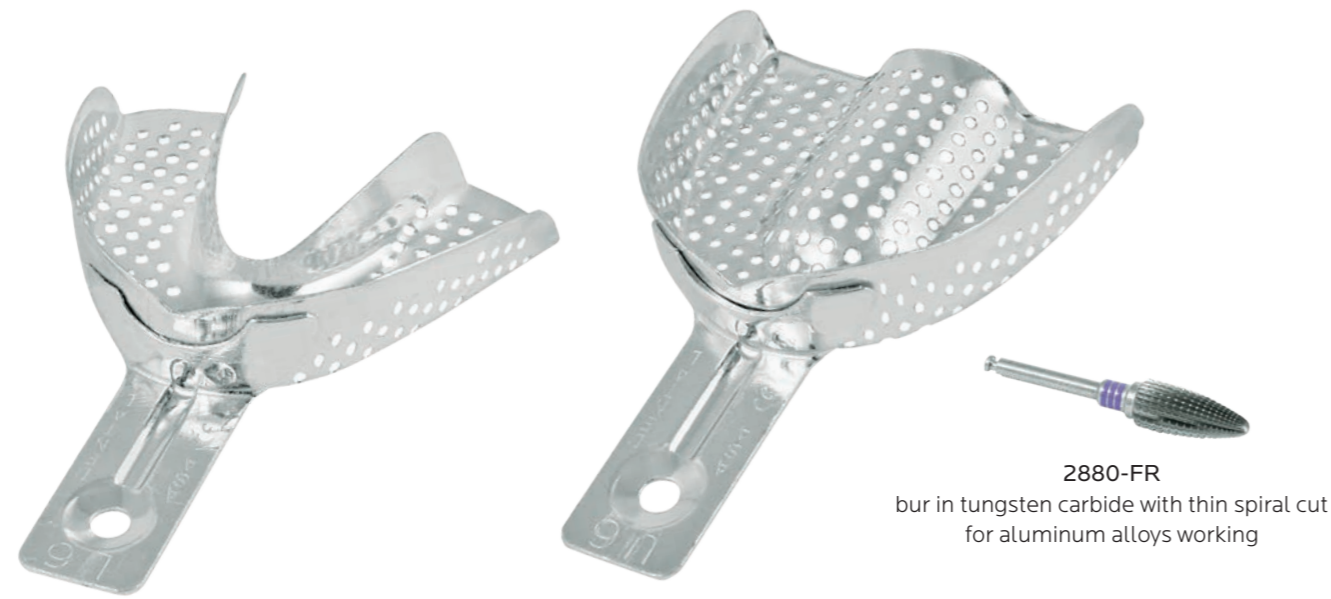

2880-FR

bur in tungsten carbide with thin spiral cut for aluminum alloys working



S2880-12 set of 12  
S2880-12FR set of 12 plus bur

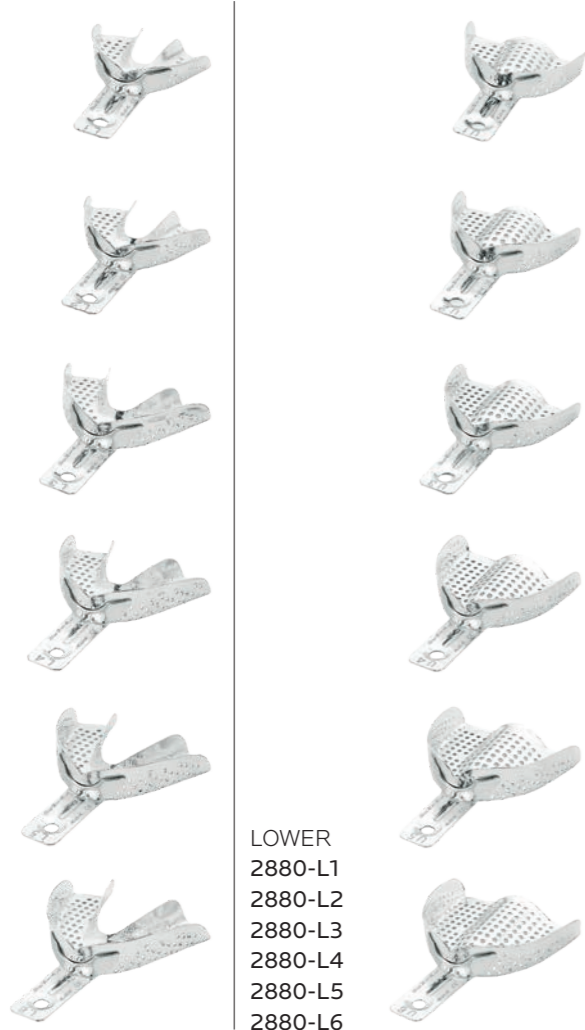

LOWER  
2880-L1  
2880-L2  
2880-L3  
2880-L4  
2880-L5  
2880-L6

UPPER  
2880-U1  
2880-U2  
2880-U3  
2880-U4  
2880-U5  
2880-U6

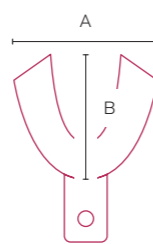

2880 LOWER		A (mm)	B (mm)
L1	XXS	56	48
L2	XS	59	50
L3	S	72	52
L4	M	76	57
L5	L	77	56
L6	XL	78	59

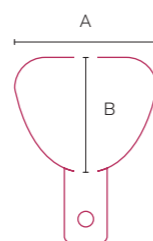

2880 UPPER		A (mm)	B (mm)
U1	XXS	63	48
U2	XS	66	51
U3	S	68	54
U4	M	71	58
U5	L	74	62
U6	XL	76	63

**Perforated aluminum impression trays - ORTHOBABY for children**

without retention rim

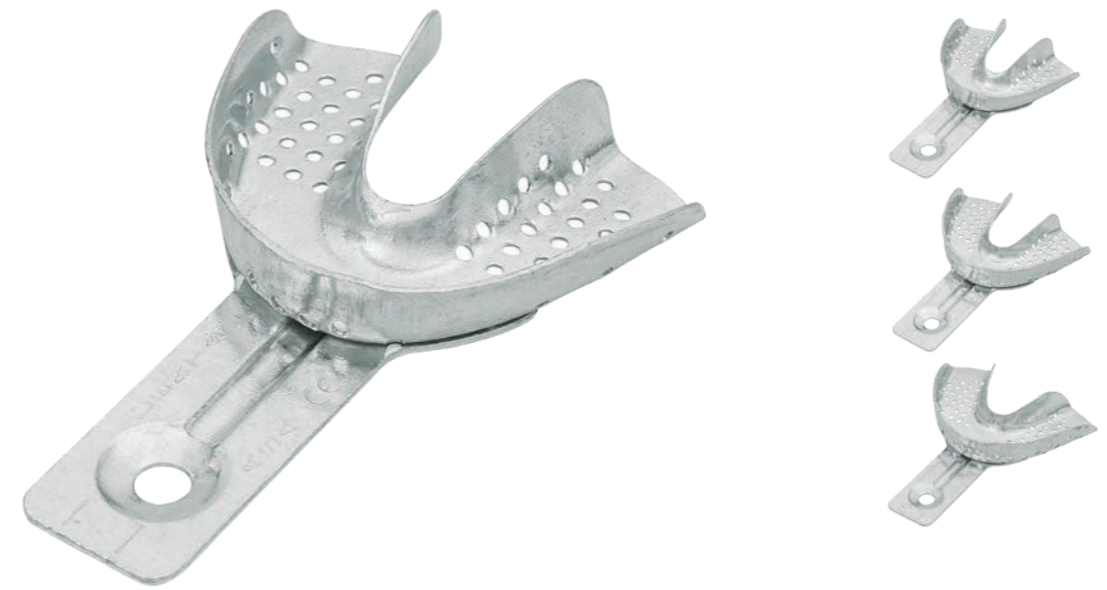

LOWER  
2816-L1  
2816-L2  
2816-L3



UPPER  
2816-U1  
2816-U2  
2816-U3



S2816-6 set of 6

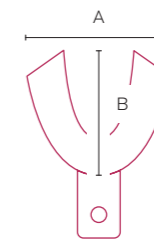

2816 LOWER		A (mm)	B (mm)
L1	S	55	45
L2	M	60	48
L3	L	69	48

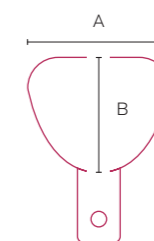

2816 UPPER		A (mm)	B (mm)
U1	S	57	38
U2	M	58	48
U3	L	63	50

**Partial occlusal stainless steel impression trays**

they allow you to take an impression of two semi-arches antagonistic



2819-OCC



2819-OCP

**AsaClean**

PH neutral solution to facilitate removal of alginate impression material from impression trays and instruments



8020  
content 1000 ml

**Perforated colour-coded aluminum impression trays for implantology**

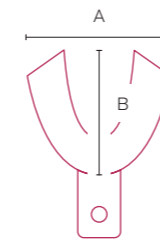

2814 LOWER		A (mm)	B (mm)
<b>L0</b>	XS	69	50
<b>L1</b>	S	72	57
<b>L2</b>	M	76	57
<b>L3</b>	L	78	59
<b>L4</b>	XL	80	63

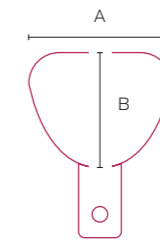

2814 UPPER		A (mm)	B (mm)
<b>U0</b>	XS	65	51
<b>U1</b>	S	67	53
<b>U2</b>	M	71	55
<b>U3</b>	L	74	60
<b>U4</b>	XL	81	63



LOWER  
2814-L0  
2814-L1  
2814-L2  
2814-L3  
2814-L4



UPPER  
2814-U0  
2814-U1  
2814-U2  
2814-U3  
2814-U4

**Polycarbonate impression trays**

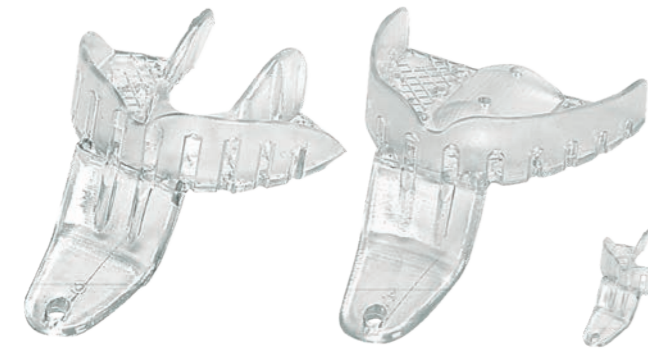

2852-12  
set of 12

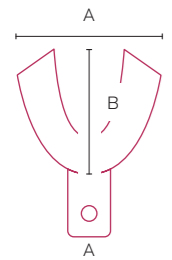

LOWER	A (mm)	B (mm)
L1	61	50
L2	67	52
L3	72	56
L4	74	58

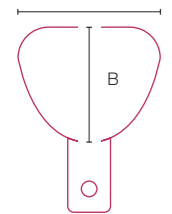

UPPER	A (mm)	B (mm)
U1	61	49
U2	65	53
U3	70	59
U4	73	6

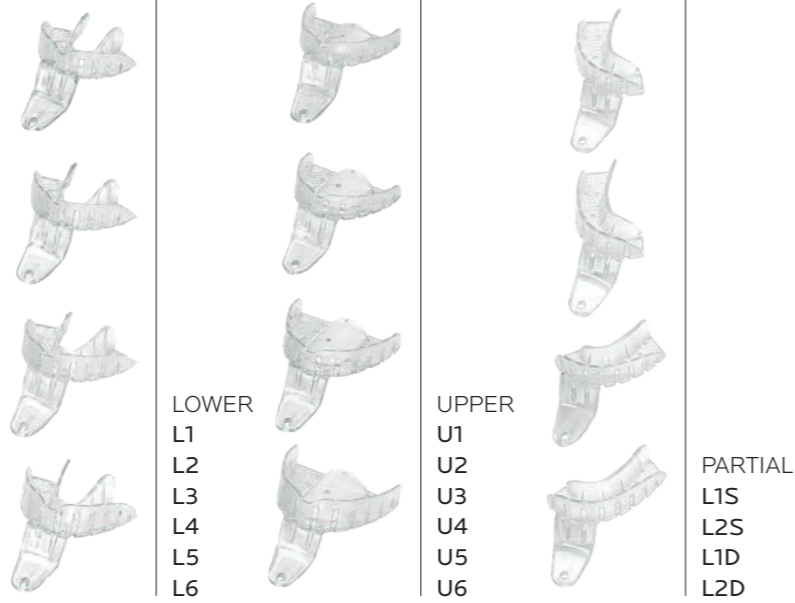

**Polycarbonate impression trays - edentulous**

autoclavable max. 130°C



S2851-24  
set of 24  
13x lower  
7x upper  
4x mixed  
compass

2851-13  
set of 13  
13x lower

2851-7  
set of 7  
7x upper

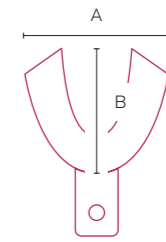

LOWER	A (mm)	B (mm)
L1	57	49
L2	58	53
L3	60	54
L4	61	55
L5	61	56
L6	61	57
L7	62	57
L8	64	55
L9	64	59
L10	66	57
L11	65	60
L12	67	58
L13	70	59

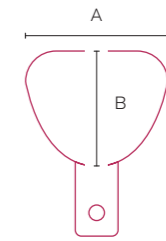

UPPER	A (mm)	B (mm)
U1	62	54
U2	63	58
U3	64	58
U4	66	60
U5	70	62
U6	75	63
U7	77	64

MIXED	A (mm)	B (mm)
U1P	64	63
U2P	67	57
L1C	75	49
L2C	76	53

**Orthodontic polycarbonate impression trays - ORTHOBABY for children**



2850-8  
set of 8

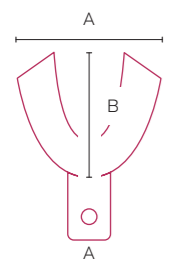

LOWER	A (mm)	B (mm)
L1	52	44
L2	58	49
L3	62	53
L4	66	56

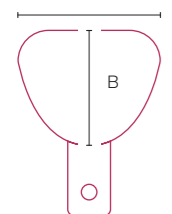

UPPER	A (mm)	B (mm)
U1	50	46
U2	56	51
U3	59	55
U4	63	59

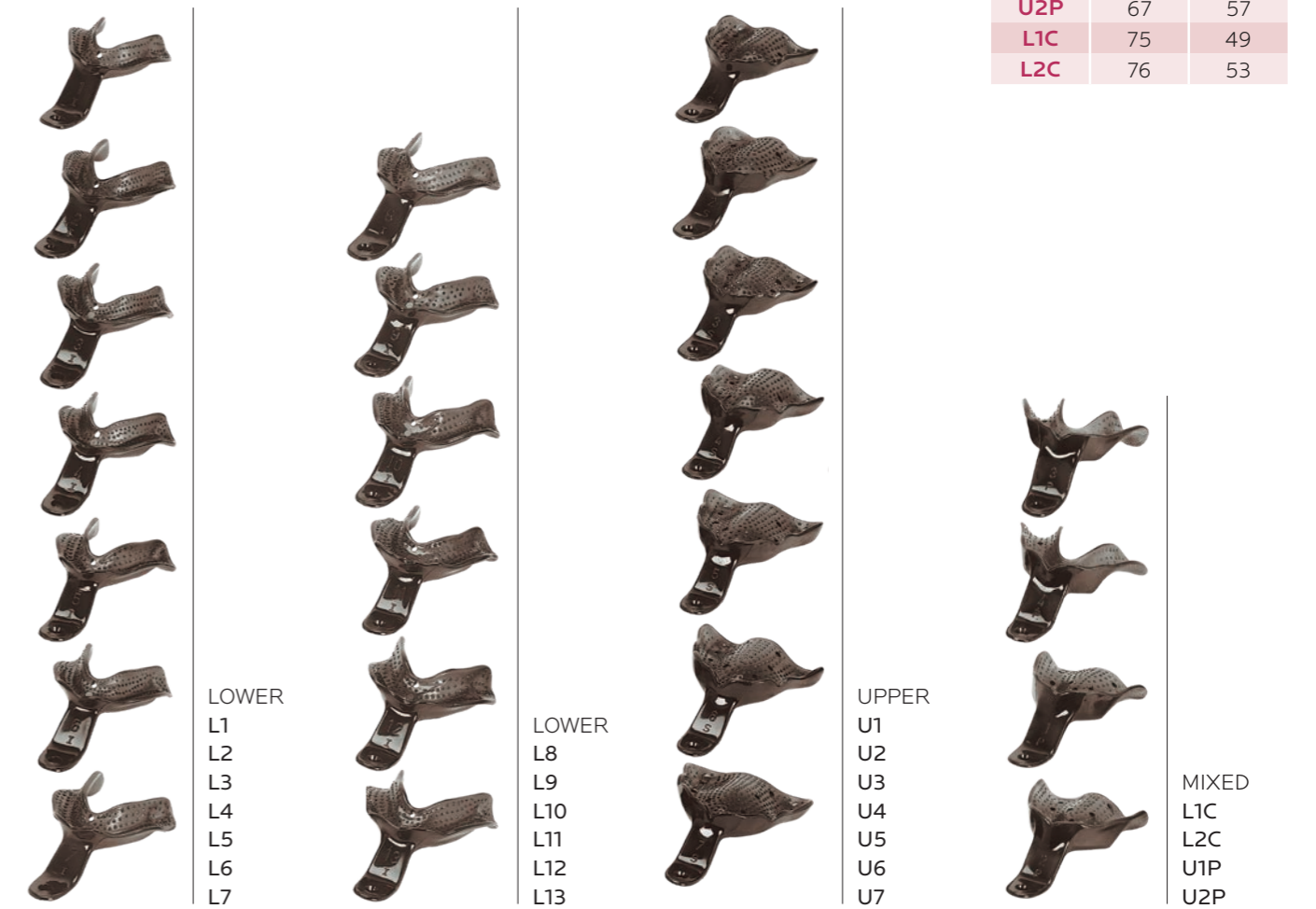
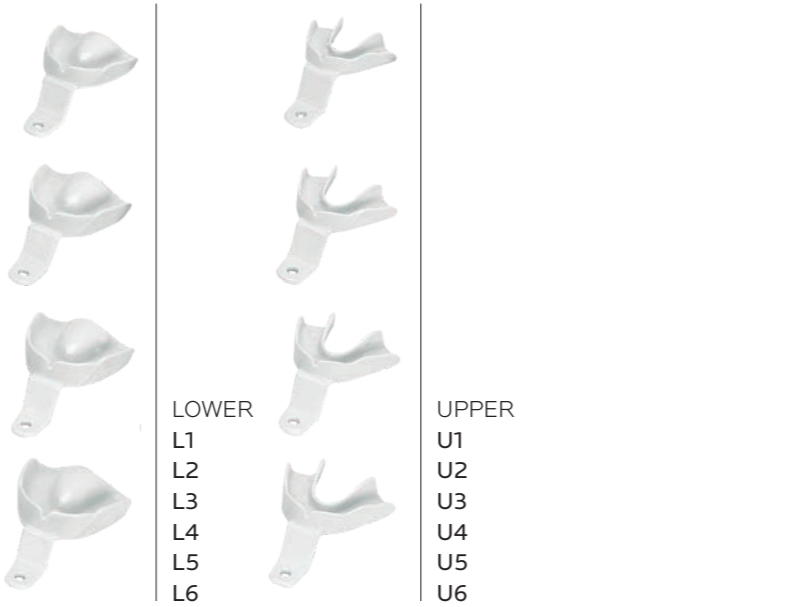

# 11 K

## LABORATORY INSTRUMENTS

MADE IN ITALY

### SKILLS AND TOOLS

No matter how good a dentist is, in order to work the magic and transform impressions into successful dental prostheses, a behind-the-scene activity from a qualified dental technician is fundamental.

Based on detailed prescriptions that include anatomical information, your job as a technician is to combine a mix of technological expertise, artistic skills, state-of-the-art materials and precise instruments to carefully create crowns, bridges, partial, removable and full dentures and more.

Asa Dental Laboratory instruments range from highly versatile articulators to precise carving instruments, through a wide range of accessories; all necessary to shape materials and make sure you can confidently help dentists restore both function and aesthetics of a patient's mouth.

- K2 Articulators
- K10 Easy Bow
- K13 Wax carvers
- K18 Waxing instruments
- K19 Tweezers
- K20 Ceramic sculpturing brushes
- K21 Ceramic sculpturing instruments
- K22 Knives
- K24 Spatulas and bowls
- K27 Prothesis boxes
- K28 Scissors
- K29 Crown instruments
- K30 Calipers
- K31 Mallets
- K32 Crucible tongs
- K33 Saws and Blades
- K34 Kits



## ARTICULATORS average values

5050 and 5050Plus are non-Arcon average value articulators designed to help dental technicians meet dentists' requests for high precision regardless of the prosthetic technique. A light, stable and ergonomic construction facilitates set-up and work on any models. Additional features guarantee an exact simulation of the condylar path with a high fitting accuracy, giving prosthesis and restorations the necessary occlusion and function throughout the full range of mandibular movements.

5050 can conveniently work with dentures of many different sizes and any electronic pressure polymerizers available on the market. Designed to obtain optimal ergonomics, it offers complete stability when the technician comfortably works at 60° or upside down, in case of class III edentulous patients. The anti-rotational system for the incisal rod ensures that positioning is always correct and accurate, while the back blocking systems allows removing the rod and conveniently working on incisors. When the technique requires starting from one of the upper arches, the mounting plate helps regardless the size of the arch with clear indication of elliptic references.

### FEATURES

- stable 60° operation for technician comfort
- ideal for class III patients
- compatible with any pressure polymerizers
- anti-rotation system for incisal rod
- template with 4 elliptic references for lower arch models
- occlusal table with 4 elliptic references for upper arch models
- bearing rod for 180° opening
- hinge rod with anti-shock protection system

### TECHNICAL DATA

intercondylar distance	110 mm
condylar inclination fixed at	30°
Bennett angle	0 - 7°
incisal table inclination	10°
distance between mounting plates	87 mm
opening	180°

### EQUIPMENT

4 mounting plates	5000-1
2 locking knobs	5011-6



5050

## ARTICULATORS average values

5050Plus is the most versatile articulator that complements Asa Dental laboratory instruments. 5050Plus is available as a standalone product or as an upgrade of 5050, with the addition of few accessories. Offering all the standard features of 5050, with a dedicated mounting plate the articulator becomes the ideal solution for all the techniques based on building the prosthetics on lower arches while a magnetic incisal rod safely prevents undesired alteration of the model during cast solidification. Simple, accurate and ergonomic, 5050Plus represents our best solution for dental technicians asking for a flexible and reliable average value, non-Arcon articulator.

### FEATURES

- stable 60° operation for technician comfort
- ideal for class III patients
- compatible with any pressure polymerizers
- anti-rotation system for incisal rod
- total stability when working without incisal rod
- template with 4 elliptic references for lower arch models
- occlusal table with 4 elliptic references for upper arch models
- magnetic incisal rod for total stability
- bearing rod for 180° opening
- hinge rod with anti-shock protection system

### TECHNICAL DATA

intercondylar distance	110 mm
condylar inclination fixed at	30°
Bennett angle	0 - 7°
incisal table inclination	0°
distance between mounting plates	87 mm
inclined contrast table	24°
opening	180°

### EQUIPMENT

4 mounting plates	5000-1
2 locking knobs	5011-6



5050Plus

## ARTICULATORS average values

lightweight anatomic articulator made of aluminum die-casting;  
it can be used following the geometrical laws of medium values (Bonwill triangle);  
fixing according to centric;  
automatic return to the hinge axis with springs;  
anti-shock hinge rod in case articulator falls accidentally;  
bigger size lock screws for mounting plates;  
anatomic back shoulders favour a practical and efficient holding of the articulator

### FEATURES

- increased height and width
- more space when using removable stumps systems
- more space for installation of mobile prosthesis with high chewing or big base
- more space when using magnetic plates
- better back entrance
- variable internal working distance
- incisal guide rod and bearing rod for 180° opening are in stainless steel
- stainless steel hinge rod
- anti-shock protection system

### TECHNICAL DATA

intercondylar distance	120 mm
condylar inclination fixed at	30°
Bennett angle fixed at	7°
incisal table inclination	10°
distance between mounting plates	90-110 mm
weight	700 gr
opening	180°

### EQUIPMENT

2 spacers	5030-29
4 mounting plates	5000-1
2 locking knobs for spacer	5030-6
2 locking knobs for plates	5011-6

### ACCESSORIES

face bow	5021
transfer table	5024
occlusal table	5030-2
fast caliper	5033



5030

## ARTICULATORS average values

features 5032 - same features as mod. 5030 plus:  
adjustable back rod by registration screw to work without incisal rod by keeping constant trajectories and inclinations during side and back/forward movements;  
pure translation movement (key and instructions included)

### FEATURES

- back rod on the upper side to unchanged back entrance and visibility and easy mechanisms regulation
- hinge rod with pure translation movement allowed

### TECHNICAL DATA

intercondylar distance	120 mm
condylar inclination fixed at	30°
Bennett angle fixed at	7°
incisal table inclination	10°
distance between mounting plates	90-110 mm
weight	700 gr
opening	180°

### EQUIPMENT

2 spacers	5030-29
2 magnetic mounting plates	5000-1M
2 locking knobs for spacer	5030-6
2 locking knobs for plates	5011-6

### ACCESSORIES

face bow	5021
transfer table	5024
occlusal table	5030-2
fast caliper	5033



5032

**ARTICULATORS**  
average values

EQUIPMENT

2 mounting plates	5000-1
2 locking knobs for plates	5011-6



5002

**occlusor**

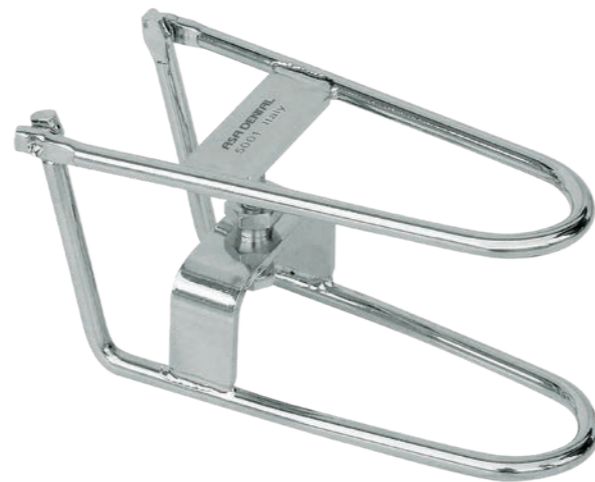

5001

**spare parts**

mounting plate  
die-casting aluminum mounting plate  
applicable to articulators

- 5050
- 5050Plus
- 5030
- 5032
- 5002
- 5000
- 5010
- 5011



5000-1

**ARTICULATORS**  
spare parts



5000-26  
magnet



5000-26

5000-30  
magnet holder



5000-30

5000-1M

- die-casting aluminum teflon covered mounting plate
- magnet holder (5000-30)
- magnet (5000-26)

applicable to articulators

- 5050
- 5050Plus
- 5030
- 5032
- 5002
- 5000
- 5010
- 5011

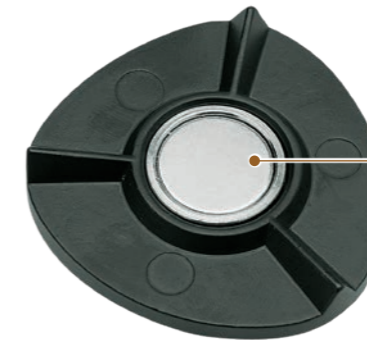

5000-1M



5000-30



5000-26

5000-25  
cast fastening washer  
for die-casting aluminum  
mounting plate  
10 pcs / pack



5000-25

5030-29

spacer  
applicable to articulators

- 5030
- 5032



5030-29

**ARTICULATORS**  
spare parts

**5050Plus**

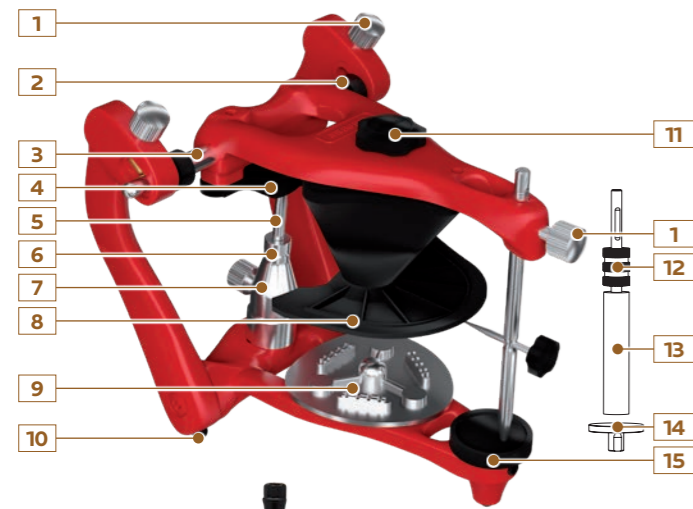

**5050**

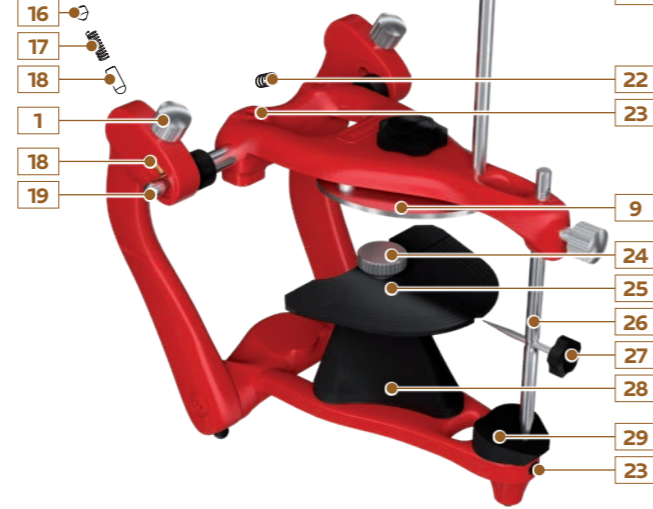

**5030/5032**

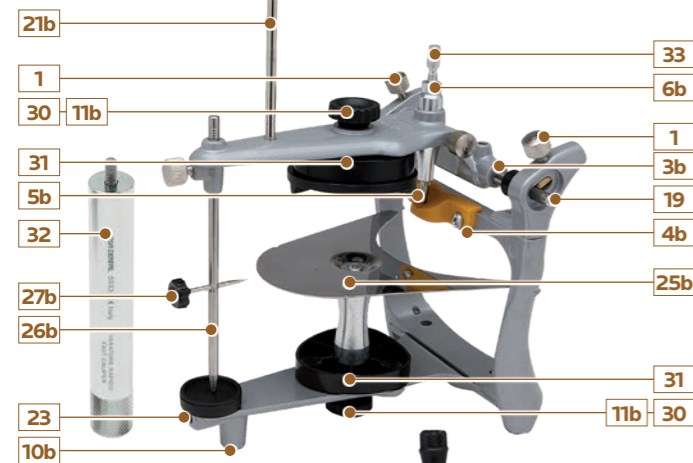

**5000/5010**

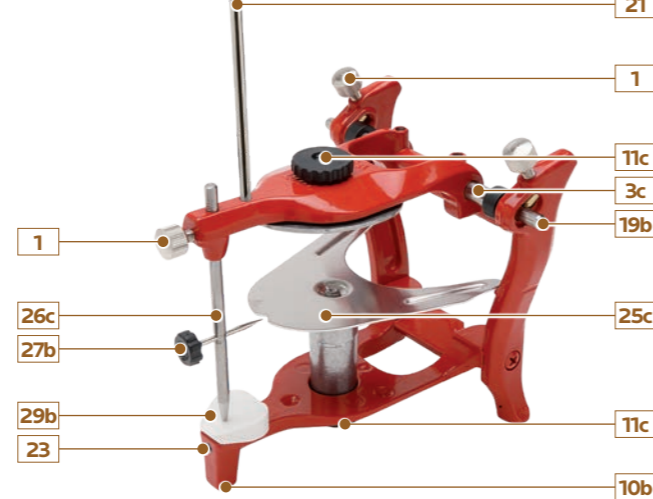

**5011**

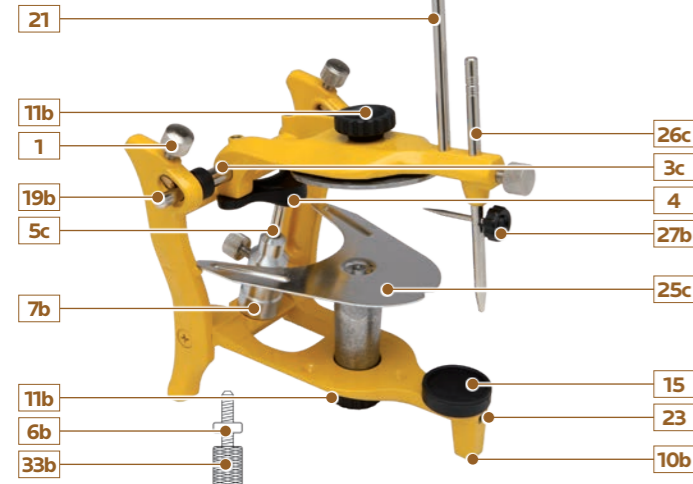

**ARTICULATORS**  
spare parts

		CURRENT MODELS					OLD MODELS		
		5050Plus	5050	5032	5030	5002	5011	5010	5000
1	metallic locking knob	5000-5	5000-5	5000-5	5000-5		5000-5	5000-5	5000-5
2	hinge rod washer	5011-18	5011-18	5011-18	5011-18		5011-18	5011-18	5011-18
3,3b,3c	hinge rod	5050-17	5050-17	5032-17	5032-17		5011-17	5011-17	5011-17
4,4b	inclined contrast table	5011-16		5032-16			5011-16		
5,5b,5c	back rod	5050-21		5032-21			5011-21		
6,6b	adjusting screw locknut	5011-23		5032-23			5011-23		
7,7b	back rod support	5050-20					5011-20		
8	template	5052	5052						
9	mounting plate	5000-1	5000-1	5000-1	5000-1	5000-1	5000-1	5000-1	5000-1
10,10b	rubber nubs (6 pcs/pack)	5050-24	5050-24	5000-24	5000-24		5000-24	5000-24	5000-24
11,11b,11c	locking knob	5050-6	5050-6	5011-6	5011-6	5000-6	5011-6	5000-6	5000-6
12	rod ferrule	5053-2							
13	magnetic rod	5053-1							
14	table for magnetic rod	5053-3							
12+13+14	magnetic rod kit	5053							
15	incisal guide table (0°)	5011-4		5011-4			5011-4		
16	adjusting screw - side shift	5000-7	5000-7	5000-7	5000-7		5000-7	5000-7	5000-7
17	side shift spring	5000-12	5000-12	5000-12	5000-12		5000-12	5000-12	5000-12
18	side shift cylinder	5000-13	5000-13	5000-13	5000-13		5000-13	5000-13	5000-13
19,19b	condylar guidance	5030-9	5030-9	5030-9	5030-9		5011-9	5011-9	5011-9
20	rubber cap	5011-11	5011-11	5011-11	5011-11		5011-11	5011-11	
21,21b	bearing rod	5010-10	5010-10	5030-10	5030-10		5010-10	5010-10	
22	hinge rod spring	5011-19	5011-19	5011-19	5011-19		5011-19	5011-19	5011-19
23	M5 screw - incisal table	5000-18	5000-18	5000-18	5000-18		5000-18	5000-18	5000-18
24	knurled knob for template and occlusal table	5050-4	5050-4						
25,25b,25c	occlusal table	5051	5051	5030-2	5030-2		5000-2	5000-2	5000-2
26,26b,26c	incisal guide rod	5050-3	5050-3	5030-3	5030-3		5000-3	5000-3	5000-3
27,27b	incisal pin	5050-8	5050-8	5000-8	5000-8		5000-8	5000-8	5000-8
28	support for occlusal table and template	5050-2	5050-2						
24+25+28	occlusal table assembly (5050-4 + 5051 + 5050-2)	5054	5054						
29,29b	incisal guide table (10°)		5000-4N		5000-4			5000-4	5000-4
30	locking knob for spacer			5030-6	5030-6				
31	spacer			5030-29	5030-29				
32	fast caliper			5033	5033				
33,33b	adjusting screw			5032-22			5011-22		
34	magnetic mounting plate - complete	5000-1M	5000-1M	5000-1M	5000-1M	5000-1M	5000-1M	5000-1M	5000-1M
35	magnet	5000-26	5000-26	5000-26	5000-26	5000-26	5000-26	5000-26	5000-26
36	cast fastening washers (10 pcs/pack)	5000-25	5000-25	5000-25	5000-25	5000-25	5000-25	5000-25	5000-25
37	magnet holder	5000-30	5000-30	5000-30	5000-30	5000-30	5000-30	5000-30	5000-30

### Easy Bow

5020

complete set including facebow with three forks and transfer table for articulator

face bow	5021
fork holder block	5022
transfer table	5024
fork	5023-1
fork	5023-2
fork	5023-3

set applicable to articulators

5030

5032



5021



5022

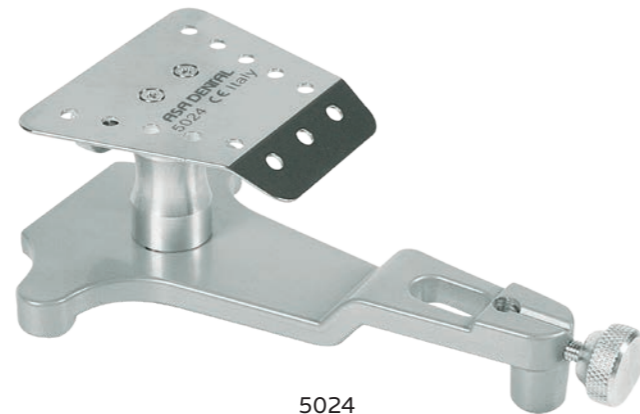

5024



5023-1



5023-2



5023-3

### Easy Bow

instructions

1. insert the fork holder block into the arch
2. insert the fork into the patient's mouth
3. pull the ear olives outwards and insert the facebow



### Easy Bow

instructions

4. regulate the Nasion position referring to the Frankfurt plan
5. connect the fork holder rod and lock all the knobs
6. face bow installed

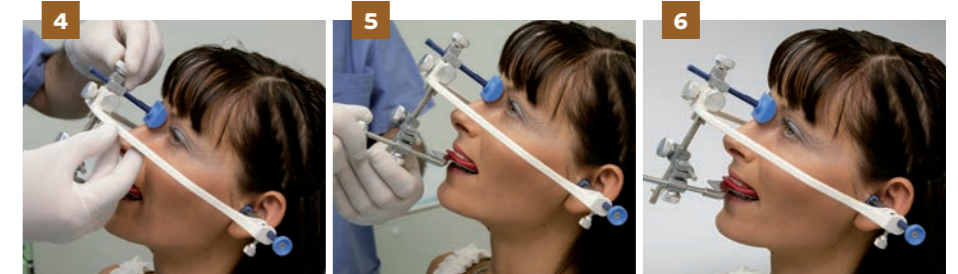

7. pull the ear olives outwards and extract the face bow
8. loosen the knob and take away the fork holder block
9. place the fork holder block into the transfer table...

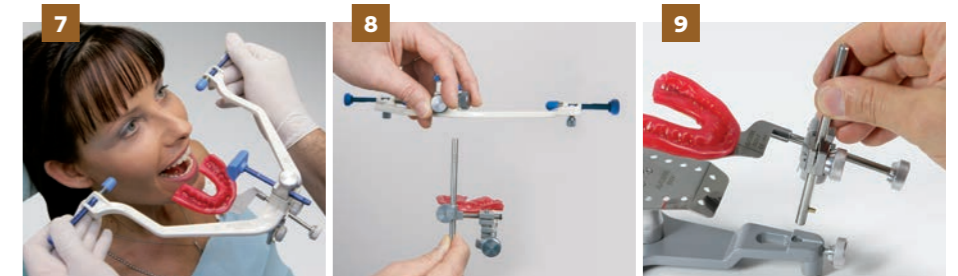

10. ...and fix the knob
11. if it is necessary regulate the little plate height; then remove the fork holder block
12. place the plaster on the plate and place again the fork holder block



13. after plaster hardening release the rod knob connected to the fork...
14. ...and extract the rod
15. release the knob and extract the fork holder block



16. place the table on the articulator...
17. ...inserting into the special lodges
18. fix the table on the articulator with the screw given with the articulator



19. place the model on the wax bite
20. put the plaster on the model...
21. ...end up the "articulator setting" as usual



Handle options

SINGLE END

● Alu80  
(aluminum, hollow)  
ø 8.0 mm



DOUBLE END

Asa60  
(stainless steel)  
ø 6.0 mm



Asa Light MV  
(stainless steel, hollow)  
ø 8.0 mm



● Alu80  
(aluminum, hollow)  
ø 8.0 mm



● Magic Color MC  
(aluminum core and  
non-slip plastic)  
ø 8.0 / 10.5 mm



Wax and modelling carvers

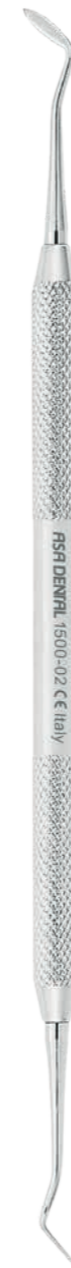

**1/2 Hollenback**  
1500-02  
Asa60  
MV1500-02  
Asa Light MV  
MC1500-02

● Magic Color MC

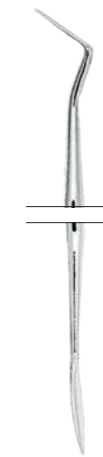

**1 Ward**  
1501-1  
Asa60  
MV1501-1  
Asa Light MV



**1S Ward**  
1501-1S  
Asa60  
MV1501-1S  
Asa Light MV

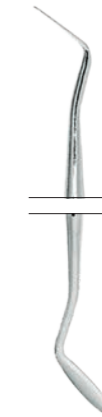

**2 Ward**  
1501-2  
Asa60  
MV1501-2  
Asa Light MV

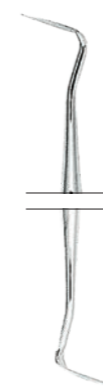

**3 Hollenback**  
1500-3  
Asa60  
MV1500-3  
Asa Light MV



**3S Hollenback**  
1500-3S  
Asa60  
MV1500-3S  
Asa Light MV



**1 Frahm**  
1502-1  
Asa60  
MV1502-1  
Asa Light MV



**2 USC**  
1503-2  
Asa60

Wax and modelling carvers

Wax and modelling carvers



Hylin  
graded handle  
in mm  
5100-1

Hylin  
5100

Hylin-Le Cron  
5101

Hylin-Ceramica  
5102

Hylin-ASA  
5103

ASA  
5104

Le Cron  
5105

Le Cron  
5106

Le Cron  
5107

Le Cron  
5108

Zahle  
5109

Zahle  
5110

Wax and modelling carvers

Wax and modelling carvers

sets of 5

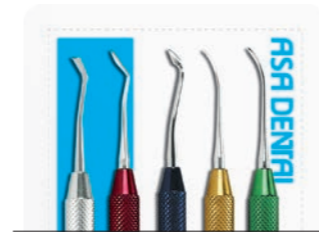

1 · 2 · 3 · 4 · 5  
S5112  
Asa60  
1AL · 2AL · 3AL · 4AL · 5AL  
S5112AL  
Alu80



Zahle  
5111



Gritman  
5113



Beale  
5114



Roach  
5115



Vehe  
5116



1 P.K. Thomas  
5112-1  
Asa60

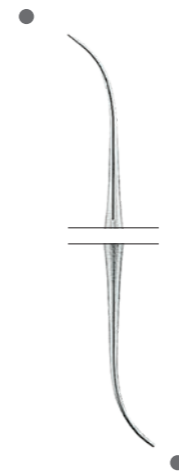

2 P.K. Thomas  
5112-2  
Asa60



3 P.K. Thomas  
5112-3  
Asa60

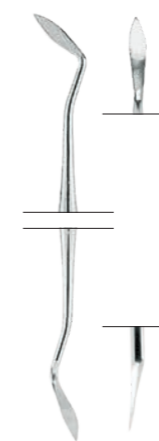

4 P.K. Thomas  
5112-4  
Asa60

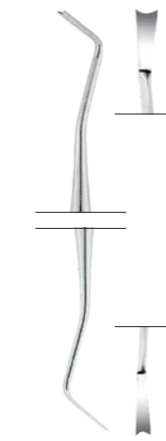

5 P.K. Thomas  
5112-5  
Asa60



1 P.K. Thomas  
5112-1AL  
Alu80



2 P.K. Thomas  
5112-2AL  
Alu80

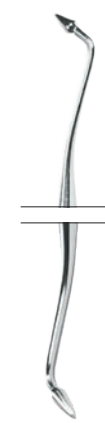

3 P.K. Thomas  
5112-3AL  
Alu80

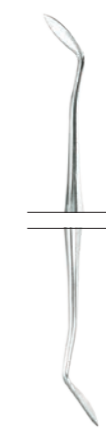

4 P.K. Thomas  
5112-4AL  
Alu80

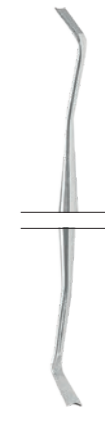

5 P.K. Thomas  
5112-5AL  
Alu80

Waxing instruments with replaceable tips

set of 3+3



1 · 2 · 3 · 1C · 2C · 3C  
S5160

Laboratory tweezers



1  
S5160-1C  
● Alu80



2  
S5160-2C  
● Alu80



3  
S5160-3C  
● Alu80



1  
5160-1



2  
5160-2



3  
5160-3



1  
16.5 cm  
6400-1



2  
16 cm  
6400-2



3 Meriam  
16 cm  
0601-3



2  
12 cm  
0645-2



3  
11.5 cm  
0645-3



3  
15 cm  
0635-3



4  
18 cm  
0635-4



6  
26 cm  
0635-6

Ceramic sculpturing brushes

set of 10



7000-6 · 7000-7 · 7000-8  
 7001-3 · 7001-1 · 7001-0 · 7001-00  
 7002-4 · 7002-6 · 7002-8  
 S7000-10



7000-6   7000-7   7000-8   7001-3   7001-1   7001-0   7001-00   7002-4   7002-6   7002-8

Ceramic sculpturing instruments

sets of 3 handles + 6 blades



5150-1 · 5150-2 · 5150-3  
 5156-1 · 5156-2 · 5156-3  
 5150

5151-1 · 5151-2 · 5151-3  
 5156-1 · 5156-2 · 5156-3  
 5151



1 5150-1   2 5150-2   3 5150-3  
 ● Alu80   ● Alu80   ● Alu80

1 Greenstein 2 Greenstein 3 Greenstein  
 5151-1   5151-2   5151-3  
 ● Alu80   ● Alu80   ● Alu80

FLEXIBLE BLADES   SUPERFLEXIBLE BLADES

1 5155-1   1 5156-1

2 5155-2   2 5156-2

3 5155-3   3 5156-3

Wax knives

Plaster knives



WITH SMALL SPOON WITH SMALL SPOON

1 Fahnenstock  
12.5 cm  
5200-1

2 Fahnenstock  
17 cm  
5200-2

1 Lessmann  
12.5 cm  
5201-1

2 Lessmann  
17 cm  
5201-2

1  
12.5 cm  
5202-1

2  
17 cm  
5202-2

1  
17 cm  
5300-1

2  
Gritman  
17 cm  
5300-2

3  
16 cm  
5300-3

4  
16 cm  
5300-4

the wooden handle may suffer color changes

the wooden handle may suffer color changes

**Rigid spatulas for plaster, alginate and elastomers**

alginate, plaster

alginate

elastomers

**Flexible spatulas for plaster, alginate and elastomers**

alginate, plaster

alginate

elastomers



the wooden handle may suffer color changes

the wooden handle may suffer color changes

**Spatulas for plaster and alginate**



19 cm 5401-B    19 cm 5401-C    19 cm 5401-F    19 cm 5401-G    19 cm 5401-R    19 cm 5401-V

**Mixing bowls for plaster and alginate**



Ø 160 mm    Ø 140 mm    Ø 120 mm    Ø 100 mm  
 2.2 L 5500-16    0.9 L 5500-14    0.5 L 5500-12    0.35 L 5500-10



Ø 160 mm    Ø 140 mm    Ø 120 mm    Ø 100 mm  
 2.2 L 5501-16    0.9 L 5501-14    0.5 L 5501-12    0.35 L 5501-10

**Ortho/prothesis boxes**

plastic box for removable retainers  
 10 pcs / pack



Blue 6900E-A



White 6900E-B



Light blue 6900E-C



Yellow 6900E-G



Pink 6900E-R



Green 6900E-V

**Scissors**

for gold foils



**1**  
straight  
12 cm  
0300-1



**2**  
curved  
12 cm  
0300-2



wire scissor  
one blade serrated

**Universal**  
12 cm  
5700

**Crown scissors**



**1**  
straight  
one blade serrated  
10.5 cm  
5600-1



**2**  
curved  
one blade serrated  
10.5 cm  
5600-2



**1**  
straight  
10.5 cm  
5601-1



**2**  
curved  
10.5 cm  
5601-2

**Crown instruments**



13 cm  
0545-1

telescope crown pliers

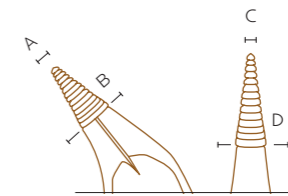

A	4.4 mm
B	5.0 mm

C	3.4 mm
D	3.8 mm

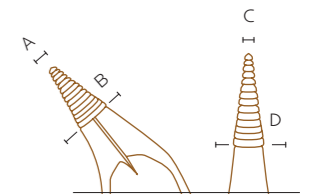

A	3.3 mm
B	4.0 mm

C	2.3 mm
D	3.0 mm



**Bohm**  
14.5 cm  
2500-2



**Bohm**  
11.5 cm  
2500-1

**Calipers**

spring calipers

measuring range: 0-10 mm



**Iwanson  
for wax  
2550-1**

measuring range: 0-10 mm



**Iwanson  
for metal  
2550-2**

measuring range: 0-15 mm



**18 cm  
2557-1**

decimal calipers

measuring range:  
0-200 mm / 0-7 in

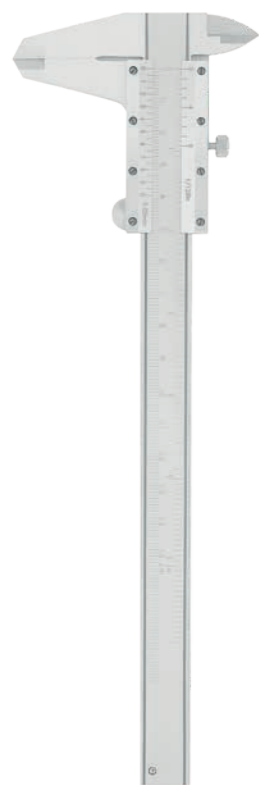

**aluminum  
graded in mm and in  
2556-1**

measuring range:  
0-100 mm / 0-4 in



**Townley  
graded in mm and in  
2556-2**

measuring range:  
0-100 mm / 0-4 in



**Jameson  
graded in mm and in  
2556-3**

measuring range:  
0-100 mm



**Boley  
14 cm  
2555**

indicative measures

**Plaster cutting pliers**



**Asa Special Inox  
19.5 cm  
5900**

**Mallets**

riveting mallets



**22 cm  
6000**



**22 cm  
6001**

horn mallet



**20 cm  
6002**

Crucible tongs



31 cm  
6600-5



40 cm  
6600-4



51 cm  
6600-2

Saws and Blades

fret saw



25 cm  
6200

fret saw blades  
12 pcs / pack

130 mm x Ø 1.3 mm  
for plaster  
6201-1

130 x 0.52 x 0.26 mm  
for metal  
6201-2

saw for models



18 cm  
6300

fret saw blades  
12 pcs / pack

75 x 3 x 0.25 mm  
6301-1

75 x 5 x 0.25 mm  
6301-2

75 x 3 x 0.12 mm  
6301-3

length x height x thickness

“Lab Set” for Laboratory

case with wax modelling and porcelain instruments



S6811-1

1	Greenstein ceramic sculpturing brush	5151-1
2	Greenstein ceramic sculpturing brush	5151-2
3	Greenstein ceramic sculpturing brush	5151-3
1	ceramic sculpturing blade	5156-1
2	ceramic sculpturing blade	5156-2
3	ceramic sculpturing blade	5156-3
1	P.K. Thomas modelling carver	5112-1AL
2	P.K. Thomas modelling carver	5112-2AL
3	P.K. Thomas modelling carver	5112-3AL
4	P.K. Thomas modelling carver	5112-4AL
5	P.K. Thomas modelling carver	5112-5AL
1	ceramic sculpturing instrument	S5160-1C
2	ceramic sculpturing instrument	S5160-2C
3	ceramic sculpturing instrument	S5160-3C
1	Lessman wax knife	5201-1
2	Lessman wax knife	5201-2
1	wax knife with spoon	5202-1
	porcelain sculpturing brushes	7000-7
	porcelain sculpturing brushes	7001-1
	porcelain sculpturing brushes	7002-8

case with wax modelling and porcelain instruments



S6811-2

	Hysin modelling carver	5100
	Hysin-Le Cron modelling carver	5101
	Hysin modelling carver	5105
	Zahle modelling carver	5111
1	P.K. Thomas modelling carver	5112-1
2	P.K. Thomas modelling carver	5112-2
3	P.K. Thomas modelling carver	5112-3
4	P.K. Thomas modelling carver	5112-4
5	P.K. Thomas modelling carver	5112-5
	Gritman modelling carver	5113
1	ceramic sculpturing instrument	S5160-1C
2	ceramic sculpturing instrument	S5160-2C
3	ceramic sculpturing instrument	S5160-3C
1	Fahnenstock wax knife	5200-1
2	Fahnenstock wax knife	5200-2
	caliper	2555

empty case for 17 instruments



8000

“Lab Set” for Laboratory

laboratory set with plastic case



S6810-1

2	laboratory tweezers	6400-2
	plaster cutting pliers	5900
	saw for models	6300
	mixing bowl - ø 120 mm	5500-12
2	crown scissors	5600-2
6	spatula for plaster and alginate	5400-6
2	Gritman plaster knife	5300-2
1	Fahnenstock wax knife	5200-1
2	Fahnenstock wax knife	5200-2
	wire forming pliers	5801-1
	Iwanson caliper	2550-2
	mallet	6001
	Hysin modelling carver	5100
	Hysin-Le Cron modelling carver	5101
	Hysin-Ceramica modelling carver	5102
	Hysin modelling carver	5105
	Le Cron modelling carver	5106
	Zahle modelling carver	5109
	Gritman modelling carver	5113
	Beale modelling carver	5114
1	P.K. Thomas modelling carver	5112-1
2	P.K. Thomas modelling carver	5112-2
3	P.K. Thomas modelling carver	5112-3
4	P.K. Thomas modelling carver	5112-4
5	P.K. Thomas modelling carver	5112-5

laboratory set with plastic case



S6810-2

2	laboratory tweezers	6400-2
	plaster cutting pliers	5900
	saw for models	6300
	mixing bowl - ø 120 mm	5500-12
2	crown scissors	5600-2
6	spatula for plaster and alginate	5400-6
2	Gritman plaster knife	5300-2
1	Fahnenstock wax knife	5200-1
2	Fahnenstock wax knife	5200-2
	Iwanson caliper	2550-2
	ceramic sculpturing instruments set	5150
	Hysin-Le Cron modelling carver	5101
	Le Cron modelling carver	5106
	Zahle modelling carver	5109
	Gritman modelling carver	5113
	Beale modelling carver	5114
1	P.K. Thomas modelling carver	5112-1
2	P.K. Thomas modelling carver	5112-2
3	P.K. Thomas modelling carver	5112-3
4	P.K. Thomas modelling carver	5112-4
5	P.K. Thomas modelling carver	5112-5

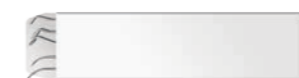

the wax and modelling carvers (5112-1-2-3-4-5) are included in the cases S6810-1 and S6810-2 into a carton package as per image

## REPROCESSING GUIDELINES

The purpose of this document is to provide detailed instructions to guarantee the correct management of Asa Dental reusable instruments, a set of guidelines commonly referred to as reprocessing.

Reprocessing procedures have two main objectives: 1) patient and operator safety and 2) instrument integrity for effective reuse.

Reprocessing in fact involves chemical, thermal and mechanical stress necessary to guarantee that instruments can be safely reused but also capable of altering instruments effectiveness.

Reprocessing applies to all non-disposable medical instruments designed to be reused over time on many different patients. The involved operations are subject to international guidelines for sterilization and to manufacturer's instructions for use regarding material, shape and application.

For this reason all Asa Dental instruments must be cleaned and sterilized before every use, including the first one.

The complete reprocessing procedure involves different steps including decontamination, cleaning, disinfection, sterilization and storage, all equally important for the final results. Different factors contribute to reprocessing effectiveness including operator's proficiency, equipment quality and maintenance, chemical products, physical environment and procedures compliance. Involved operators must guarantee that all the necessary reprocessing steps are correctly and safely implemented.

International or country regulations conflicting with this document have priority and Asa Dental recommends to follow them.

### PRELIMINARY NOTES

#### Staff training

Everyone involved with reprocessing procedures must be trained and qualified beforehand. Training must include cleaning, disinfection, sterilization, and infection prevention & control procedures.

#### Safe area

Reprocessing protocol demands for a dedicated space separate from patient treatment areas and from non medical staff.

Size of the area depends on the type of dental practice, but its characteristics are general:

- Large enough to run operations
- Separation between operations and storage
- Dedicated hand-washing area
- Surfaces, walls and floors easy to clean and disinfect
- Room controls (i.e. temperature, humidity, ventilation, etc)
- Limited personnel access

#### Equipment and chemicals

The practice should be equipped with instruments and chemicals necessary for cleaning, disinfection and sterilization of instruments, all compliant with international regulations and well maintained in accordance with manufacturer's instructions.

### RECOMMENDATIONS

#### For correct instrument handling

- All brand new hinged instruments (scissors, hemostats, pliers, extracting forceps, etc. ) must be articulated at least 20 times immediately after opening the package. Extra lubricating oil must then be removed
- Following the previous operation, if applicable, proceed with instrument sterilization before use
- Used/contaminated instruments must be moved from use area to reprocessing area with appropriate containers in order to avoid any contacts with the operator and with the environment
- We strongly recommend to always apply a preliminary disinfection/decontamination to prevent operator and environment contamination that may happen during cleaning, especially when washing instruments under running water
- We strongly recommend a very accurate rinsing after any steps where the instruments has been exposed to chemical agents for cleaning and disinfecting purposes in order to remove residuals

### WORKFLOW

<b>1</b>	<b>DECONTAMINATION</b>		
<b>2</b>	<b>CLEANING</b>	<b>2A</b> <b>Automatic cleaning</b>  <b>Drying</b>	<b>2B</b> <b>Manual cleaning   Ultrasonic cleaning</b>  <b>Disinfection</b>  <b>Drying</b>
<b>3</b>	<b>INSPECTION</b>	<b>Visual check</b>  <b>Maintenance</b>	
<b>4</b>	<b>PACKAGING</b>	<b>Packaging</b>  <b>Traceability</b>	
<b>5</b>	<b>STERILIZATION</b>		
<b>6</b>	<b>STORAGE</b>		

<b>1</b>	<b>DECONTAMINATION</b>
<b>Equipment</b>	Purified or sterile water: max 100 CFU/ml e 0.5 EU/ml, as residues of hard water or water with higher contamination (microorganism and endotoxins) can cause staining of the instruments or prevent effective decontamination. Disinfectant intended for manual disinfection, applied in according to the manufacturer's guidelines concerning time and concentrations. Cassette and decontamination bath.
<b>Procedure</b>	<ol style="list-style-type: none"> <li>1. If it applies, disassemble the instrument (i.e. mirrors)</li> <li>2. Immediately after proceed removing gross organic and material residuals using soft disposable wipes and immerse instruments in a decontamination bath with a cleaning/decontaminating agent to avoid solidification of composites, cements and glass ionomers</li> <li>3. Instruments should be immersed in the decontamination bath using a sterilization cassette, depending on availability and type of instruments</li> </ol>
<b>Notes</b>	We strongly recommend to carefully place the instruments to prevent 1) injuries to operators and/or damages to sharp instruments that may affect their effective use. The guidelines provided by the cleaning/decontaminating agent manufacturer regarding concentrations and time should be strictly followed.

<b>2A</b>	<b>CLEANING   Automatic cleaning + Drying</b>
<b>Equipment</b>	Washer-disinfector. One or more cassettes of appropriate size. Cleaning agent intended for use in a washer-disinfector, selected depending on the material of the instrument, and used following the manufacturer's guidelines concerning time and concentrations; avoid cleaning agents with high pH (>8.5) in order to prevent damages to polymers and aluminum instruments. Refer to SPECIAL PROCEDURES section of this document to verify compatibility with some Asa Dental instruments with specific requirements.
<b>Procedure</b>	<ol style="list-style-type: none"> <li>1. Place the instruments in the cassette avoiding contact to avoid damages during the procedure and ensure proper washing. Arrange instruments so that those with cannulations are not horizontal and the those with blind holes are downwards to assist cleaning and drainage</li> <li>2. Load the washer</li> <li>3. Connect cannulations to the rinsing ports</li> <li>4. Activate an approved thermal disinfection program (time, temperature, rinsing steps)</li> <li>5. Wait for the program to finish and unload the device</li> <li>6. Visually inspect the instruments immediately after the cleaning for residuals and, if necessary, repeat the program</li> <li>7. Dry using filtered, compressed air device or clean, lint-free wipes</li> <li>8. In case additional drying is required proceed arranging instrument on a clean surface or heat in oven (max temperature 110°C)</li> </ol>
<b>Notes</b>	<ul style="list-style-type: none"> <li>• Ensure that the washer-disinfector is valid for the purpose (CE mark, FDA approval in accordance to ISO15883), properly installed and regularly maintained and tested</li> <li>• We do not recommend chemical disinfection programs as they may result in residuals that interfere with the sterilization phase</li> </ul>

<b>2B</b>	<b>CLEANING   Manual cleaning</b>	<b>CLEANING   Ultrasonic cleaning</b>
<b>Equipment</b>	Purified or sterile water: max 100 CFU/ml e 0.5 EU/ml, and the use of a syringe in case of instruments with hollow parts and cannulations to ensure that the cleaning solution reaches all parts. Cleaning agents: depending on the material of the instrument, follow the manufacturer's guidelines concerning time and concentrations; avoid cleaning agents with high pH (>8.5). Refer to SPECIAL PROCEDURES section of this document to verify compatibility with some Asa Dental instruments with specific requirements. Bath large enough to allow complete immersion of instruments.	<b>Equipment</b> Cleaning agent: choose the detergent depending on the instrument material and follow manufacturer's guidelines concerning time and concentration of the cleaning agent. Ultrasonic bath: must be large enough to allow complete immersion of the instrument and work in a 25 - 50 kHz frequency range, without exceeding temperatures stated by the detergent manufacturer's instructions.
<b>Procedure</b>	<ol style="list-style-type: none"> <li>1. Prepare the bath and completely immerse the instrument and all its parts</li> <li>2. In case of hollow parts and cannulations use a syringe (up to 50ml) and tilt the instrument to make sure that the cleaning agent reaches all its parts especially blind holes, hinges and joints</li> <li>3. Keep the instrument in the solution for at least the time specified by the detergent manufacturer's instructions</li> <li>4. Rinse the instrument at least 1 minute in running water and ensure that all traces of detergent solution are removed</li> <li>5. Inspect instrument, especially in case of blind holes, cavities and cannulations and, if necessary, repeat the cleaning procedure from the beginning</li> </ol>	<b>Procedure</b> <ol style="list-style-type: none"> <li>1. completely immerse the instrument and all its parts</li> <li>2. In case of hollow parts and cannulations use a syringe (up to 50ml) and tilt the instrument to make sure that the cleaning agent reaches all its parts especially blind holes, hinges and joints</li> <li>3. Activate the bath for minimum of 15 minutes or the time recommended by the detergent's manufacturer</li> <li>4. Rinse the instrument at least 1 minute in running water and ensure that all traces of detergent solution are removed</li> <li>5. Inspect instrument, especially in case of blind holes, cavities and cannulations and, if necessary, repeat the cleaning procedure from the beginning</li> </ol>
<b>Notes</b>	WARNING: automatic cleaning is always to be preferred to manual cleaning, even in case of manual cleaning with an ultrasonic device. Manual cleaning should be used only when the instrument properties are not compatible with automatic cleaning. Never use metal brushes or other tools that may damage the instrument.	<b>Notes</b> WARNING: automatic cleaning is always to be preferred to manual cleaning, even in case of manual cleaning with an ultrasonic device. Manual cleaning should be used only when the instrument properties are not compatible with automatic cleaning. Never use metal brushes or other tools that may damage the instrument.

	<b>CLEANING   Disinfection + Drying</b>
<b>Equipment</b>	Bath: large enough to allow complete immersion of the instrument. Purified or sterile water: max 100CFU/ml e 0.5EU/ml, and the use of a syringe in case of instruments with hollow parts and cannulations to ensure that the leaning solution reaches all parts. Disinfectant intended for manual disinfection, applied in according to the manufacturer's guidelines concerning time and concentrations. A filtered, compressed air device or clean, lint-free wipes are valid options for the drying.
<b>Procedure</b>	<ol style="list-style-type: none"> <li>1. Prepare a bath large enough to accommodate the instrument</li> <li>2. Keep the instrument in the solution for at least the time specified by the disinfectant manufacturer's instructions</li> <li>3. In case of hollow instruments, blind holes, cannulations and hinges or joints use a syringe to reach all parts at least 3 times</li> <li>4. Rinse the instrument at least 1 minute in running water until and ensure that all traces of disinfectant solution are removed from all parts especially blind holes, cavities and cannulations</li> <li>5. Dry using filtered, compressed air device or clean, lint-free wipes</li> <li>6. Inspect instrument, especially in case of blind holes, cavities and cannulations and, if necessary, repeat the cleaning procedure from the beginning</li> </ol>

<b>3</b>	<b>INSPECTION   Visual check</b>
<b>Equipment</b>	Magnifying tool and proper lighting conditions.
<b>Procedure</b>	<ol style="list-style-type: none"> <li>1. Visually inspect all the instruments</li> <li>2. Carefully check cavities, cannulations, blind holes, hinges, joints and textured surfaces (i.e. extracting forceps handles)</li> <li>3. Repeat the cleaning procedure in case of impurities, chemical residuals or other materials discovered on the instrument</li> <li>4. In case of corrosion, alteration, wear or any other modifications that may compromise or limit instrument functionality, it is mandatory to proceed with maintenance procedures</li> </ol>
<b>Notes</b>	All instruments should be inspected before proceeding with sterilization.

	<b>INSPECTION   Maintenance</b>
<b>Equipment</b>	Magnifying tool and proper lighting conditions. Anticorrosion oil and lubricating oil for stainless steel and for aluminum to protect joints and hinges. Sharpening accessories for blades and tips.
<b>Procedure</b>	<ol style="list-style-type: none"> <li>1. Visually inspect instruments to identify parts showing evidence of corrosion, wear, alteration or other defects that may alter instrument functionality</li> <li>2. In case of corrosion apply a small quantity of anticorrosion oil</li> <li>3. In case of hinged instruments like pliers, scissors and forceps, apply a small quantity of lubricating oil</li> <li>4. In case of damaged cutting edges, proceed with sharpening</li> <li>5. Always check the effectiveness of the maintenance intervention and if necessary (negative or non acceptable results) proceed with instrument scrapping and replacement</li> <li>6. After any of the above action, repeat cleaning/disinfecting procedures to remove residuals of maintenance</li> </ol>
<b>Notes</b>	Maintenance operations are strongly recommended as they have serious consequences on operators and patient safety.

**4 PACKAGING**

**Equipment** Pouches or crepe paper: certified for medical use and steam sterilization, in order to ensure steam permeability, thermal and mechanical protection throughout the sterilization process.  
A suitable cassette according to instruments size.

- Procedure**
1. In case of crepe paper, use 2 sheets of paper for each cassette
  2. Wrap cassette

Envelope wrapping method example

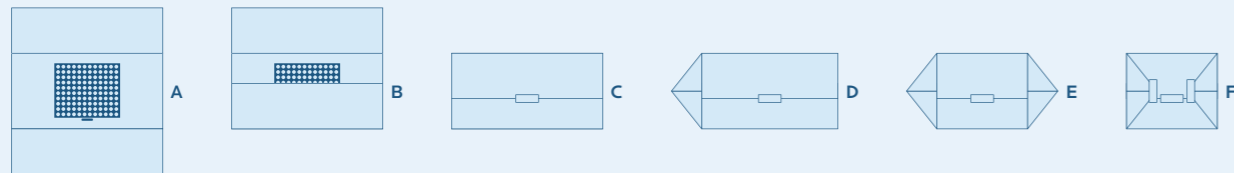

**Notes** Wrapping paper and wrapping techniques must comply with the most common standards (AAMI ST79, ISO 11607, CE mark, FDA).

**PACKAGING | Traceability**

**Equipment** Chemical indicators: compliant with ISO11138-3 and ISO11140.  
Marking pen and labels.

- Procedure**
1. Depending on type, insert or apply the chemical indicator
  2. Visibly apply the label on each cassette with the at least the following information:
    - Autoclave identifier/number
    - Packaging and sterilization date
    - Signature or operator identifier
    - Expiration date
    - Sterilization sequential number

**Notes** Six different chemical indicator types are available:  
 • Type 1, only indicate if they have been exposed to sterilization process  
 • Type 2, are for use in specific test procedures (i.e. Bowie-Dick test for air removal)  
 • Type 3, show evidence of exposure to a predetermined sterilization process variable (i.e. 134°C)  
 • Type 4, are intended to indicate exposure to 2 or more process variables (i.e. time and temperature)  
 • Type 5, react to all sterilization variables  
 • Type 6, are intended to match critical variables of specified sterilization cycles

**5 STERILIZATION**

**Equipment** Asa Dental suggests class B steam sterilizer: dimensions and features compatible with dental studio requirements, equipped with vacuum pump to remove air from the chamber and ensure sterilization of porous materials, wrapped items and instruments with cavities. The device must be compliant with the following regulations : EN285, EN13060, EN ISO17665 e ANSI/AAMI ST79. The same regulations describe also maintenance procedures and sterilization protocols regarding time and temperature. Check SPECIAL PROCEDURES section of this document for more information about care instruction of some Asa Dental products.

- Procedure**
1. Place wrapped cassettes in the sterilizer
  2. Select the sterilization program according to the protocols described below making sure to select the pre-vacuum option and wait for entire program duration:

Method (US)	Moist heat sterilization according to ANSI/AAMI ST79	Method (EU)	Moist heat sterilization according to ISO 17665
Cycle	Pre-vacuum (dynamic air removal)	Cycle	Pre-vacuum (dynamic air removal)
Temperature	132°C (270°F)	Temperature	134° - 137°C (273° - 279°F)
Duration <sup>(1)</sup>	4 minutes	Duration <sup>(1)</sup>	3 minutes
Drying time <sup>(2)</sup>	30 minutes (in chamber)	Drying time <sup>(2)</sup>	30 minutes (in chamber)

<sup>(1)</sup> Period for which the load and entire chamber is maintained at the sterilization temperature  
<sup>(2)</sup> Period during which steam is removed from the chamber and the chamber pressure is reduced to permit the evaporation of condensate from the load either by prolonged evacuation or by the injection and extraction of hot air or other gases. The drying time varies due to load configuration, wrapping method, and material

**Notes** Do not use flash or chemical sterilization with substances like formaldehyde and ethylenoxide.  
 Longer exposure time and higher temperature can be used with a potentially negative impact on instrument lifetime. We strongly recommend the use of purified or deionized water.  
 Depending on construction materials, sterilization temperatures can vary: i.e. Magic Color instruments should not be exposed to temperatures above 130°C/260°F. In order to ensure the correct working conditions for the sterilizers we recommend to refer to manufacturer's instruction manual.  
 Follow above mentioned regulation guidelines for periodic care and maintenance.

**6 STORAGE**

**Equipment** After sterilization, reusable instruments should be stored in the sterilization wrap or rigid container in a dry and dust-free place. The shelf life is dependent on the sterile barrier employed, storage manner, environmental conditions, and handling.

- Procedure**
1. Store sterilized material in the dedicated storage area
  2. Ensure the necessary separation between sterile and non-sterile packages
  3. Make sure that storage area meets humidity, temperature and hygienic storage conditions
  4. Follow the protocol that implements a sterile barrier between the storage area and other areas
  5. Always check labels, indicators and packaging integrity before using stored instruments

**Notes** Asa Dental recommends storage conditions in accordance with international guidelines: EP (European Pharmacopoeia), USP (United States Pharmacopoeia) and JP (Japanese Pharmacopoeia).  
 Sterile conditions are guaranteed only when the certified medical wrapping paper is used and the packaging is preserved unopened and undamaged.

**SPECIAL PROCEDURES**

**Aluminum instruments**  
Such as:  
 • Matrix retainers  
 • Aluminum trays  
 • Aluminum impression trays  
 • Aluminum handles

**Nylon instruments**  
Such as:  
 • Magic Color handles

**Polycarbonate instruments**  
Such as:  
 • Parts of some aspirators  
 • Some impression trays  
 • Codicolor tabs (impression trays)  
 • Some accessories for orthodontics

**Special materials**  
Some instruments have parts or coating made of special materials, such as PTFE, Teflon, Xlayer. These materials enhance performances and resistance against mechanical stress but they require a special care. The following products belong to this category:  
 • Mallets (parts)  
 • Clamps (Vision)

**WARNING:** use only automatic or manual cleaning, avoiding ultrasound cleaning. Use chemical agents following manufacturer's instructions. Chemical interaction between aluminum and stainless steel instruments processed concurrently should be carefully monitored.

**WARNING:** for these instruments sterilization temperature should not exceed 130°C/260°F, and sterilization cycles should be as short as possible.

**WARNING:** polycarbonate is a material extremely versatile for dental care applications. Anyway its mechanical structure suffers from temperatures above 130°C (266°F), hence reprocessing procedure should not exceed this threshold. The same applies to chemical agents that must be carefully selected for compatibility to prevent any damages.

**WARNING:** avoid brushing and scratching with abrasive object that may damage coating.

**INTERNATIONAL REGULATION AND REFERENCES**

AAMI TIR 12:	Design, testing and labeling reusable medical devices for reprocessing in healthcare facilities: A guide for medical device manufacturers
AAMI TIR 30:	A compendium of processes, materials, test methods, and acceptance criteria for cleaning reusable medical devices
AAMI TIR 34:	Water for reprocessing of medical devices
AAMI TIR 55:	Human factors engineering for processing medical devices
ANSI/AAMI ST 77:	Containment devices for reusable medical device sterilization
ANSI/AAMI ST 79:	Comprehensive guide to steam sterilization and sterility assurance in healthcare facilities
EN 285:	Sterilization - Steam sterilizers - Large sterilizers
EN 13060:	Small steam sterilizers
ISO 11138-3:	Sterilization of health care products - Biological indicators - Part 3: Biological indicators for moist heat sterilization processes
ISO 11140-1:	Sterilization of healthcare products - Chemical indicators - Part 1: General requirements
ISO 1607-1:	Packaging for terminally sterilized medical devices
	Part 1: Requirements for materials, sterile barrier systems and packaging systems
ISO 15883-1:	Washer-disinfectors - Part 1: General requirements, terms and definitions and tests
ISO 17664:	Sterilization of re-usable instruments - Information to be provided by the manufacturer for the processing of re-usable instruments
ISO 17665-1:	Sterilization of healthcare products, moist heat - Part 1: Requirements for the development, validation and routine control of a sterilization process for medical devices
ISO 17665-2:	Sterilization of health care products, moist heat - Part 2: Guidance on the application of ISO 17665-1
	United States Pharmacopoeia(USP)
	European Pharmacopoeia (EP)
	Japanese Pharmacopoeia (JP)
HTM-01-01:	Decontamination of surgical instruments

# CODE INDEX

code	description	handle	page
0100-1	Extracting forceps		D4
0100-2	Extracting forceps		D4
0100-3	Extracting forceps		D4
0100-4	Extracting forceps		D4
0100-7	Extracting forceps		D4
0100-8	Extracting forceps		D4
0100-13	Extracting forceps		D5
0100-17	Extracting forceps		D5
0100-18	Extracting forceps		D5
0100-18A	Extracting forceps		D5
0100-19	Extracting forceps		D6
0100-20	Extracting forceps		D5
0100-21	Extracting forceps		D5
0100-22	Extracting forceps		D6
0100-22L	Extracting forceps · Roururier		D6
0100-22R	Extracting forceps · Roururier		D7
0100-23	Extracting forceps		D7
0100-24	Extracting forceps		D7
0100-29	Extracting forceps		D7
0100-29N	Extracting forceps		D7
0100-30	Extracting forceps		D8
0100-31	Extracting forceps		D8
0100-33	Extracting forceps		D8
0100-33A	Extracting forceps		D8
0100-33L	Extracting forceps		D8
0100-38A	Extracting forceps		D8
0100-41	Extracting forceps		D8
0100-43A	Extracting forceps		D9
0100-44	Extracting forceps		D9
0100-45	Extracting forceps		D9
0100-46	Extracting forceps		D9
0100-46L	Extracting forceps		D9
0100-48	Extracting forceps		D10
0100-49	Extracting forceps		D10
0100-51	Extracting forceps		D10
0100-51A	Extracting forceps		D10
0100-51L	Extracting forceps		D10
0100-51LX	Extracting forceps		D11
0100-52	Extracting forceps		D11
0100-54	Extracting forceps		D11
0100-55	Extracting forceps		D11
0100-56	Extracting forceps		D11
0100-59	Extracting forceps		D11
0100-59L	Extracting forceps		D11
0100-60	Extracting forceps		D12
0100-65L	Extracting forceps		D12
0100-65R	Extracting forceps		D12
0100-66L	Extracting forceps		D12
0100-66R	Extracting forceps		D13
0100-67	Extracting forceps		D13
0100-67/L	Extracting forceps		D13
0100-67/R	Extracting forceps		D13
0100-67A	Extracting forceps		D13
0100-68	Extracting forceps		D14

code	description	handle	page
0100-73	Extracting forceps		D14
0100-74	Extracting forceps		D14
0100-74M	Extracting forceps		D14
0100-74N	Extracting forceps		D14
0100-75	Extracting forceps		D15
0100-79	Extracting forceps		D15
0100-79A	Extracting forceps		D15
0100-79C	Extracting forceps		D15
0100-86/L	Extracting forceps · Roururier		D16
0100-86/R	Extracting forceps · Roururier		D16
0100-86C	Extracting forceps		D16
0100-86W	Extracting forceps · White		D17
0100-87	Extracting forceps		D17
0100-89	Extracting forceps		D18
0100-90	Extracting forceps		D18
0100-99	Extracting forceps		D18
0100-107	Extracting forceps		D19
0100-121	Extracting forceps · Ogden-Felsch		D19
0100-145	Extracting forceps		D19
0100-151/	Extracting forceps		D19
0100-166	Extracting forceps · Trotter		D17
0100-167	Extracting forceps · Trotter		D20
0100-168	Extracting forceps · Trotter		D19
0100-169	Extracting forceps · Trotter		D20
0100-346	Extracting forceps		D19
0100-349	Extracting forceps		D20
0100-359	Extracting forceps		D20
0101-1	Extracting forceps for roots · Witzel		D40
0101-2	Extracting forceps for roots · Witzel		D40
0102-1	Extracting forceps for root splinters and silver cones · Stieglitz		B16 D41
0102-2	Extracting forceps for root splinters and silver cones · Stieglitz		B16 D41
0103-10	Bone rongeurs · Luer		D42 E30
0103-20	Bone rongeurs · Friedman		D42
0103-25	Bone rongeurs · Mini Friedman		D42 E30 G30
0103-30	Bone rongeurs · Blumenthal		D43 E30
0103-31	Bone rongeurs · Blumenthal		D43 E30
0103-32	Bone rongeurs · Blumenthal		D43
0103-40	Bone rongeurs · Cleveland		D42
0103-45	Bone rongeurs · Cleveland-Gardner		D42
0103-50	Bone rongeurs · Mead		D43
0103-60	Bone/soft tissue nippers · Goldman-Fox		D44 E29 G30
0103-70	Bone rongeurs · Mini-Ruskin		D44
0103-71	Bone rongeurs · Beyer		D44
0103-78	Gum guillotine forceps · Tomati		G30
0104-1	Extracting forceps · Mead		D24

code	description	handle	page
0104-2	Extracting forceps · Mead		D24
0104-3	Extracting forceps · Mead		D24
0104-4	Extracting forceps · Mead		D24
0110-13S	Extracting forceps for children		D37
0110-22S	Extracting forceps for children		D37
0110-30S	Extracting forceps for children		D37
0110-33S	Extracting forceps for children		D37
0110-37	Extracting forceps for children		D37
0110-38	Extracting forceps for children		D38
0110-39	Extracting forceps for children		D38
0110-39L	Extracting forceps for children		D38
0110-39R	Extracting forceps for children		D38
0110-51S	Extracting forceps for children		D38
0112-1	Extracting forceps for children · Klein		D39
0112-2	Extracting forceps for children · Klein		D39
0112-3	Extracting forceps for children · Klein		D39
0112-4	Extracting forceps for children · Klein		D39
0112-5	Extracting forceps for children · Klein		D39
0112-6	Extracting forceps for children · Klein		D39
0112-7	Extracting forceps for children · Klein		D39
0120-5	Extracting forceps - American pattern · Physick		D25
0120-6	Extracting forceps - American pattern		D25
0120-10S	Extracting forceps - American pattern		D25
0120-16	Extracting forceps - American pattern		D25
0120-17	Extracting forceps - American pattern		D25
0120-18L	Extracting forceps - American pattern · Harris		D26
0120-18R	Extracting forceps - American pattern · Harris		D26
0120-23	Extracting forceps - American pattern		D26
0120-53L	Extracting forceps - American pattern		D26
0120-53R	Extracting forceps - American pattern		D26
0120-65	Extracting forceps - American pattern		D27
0120-69	Extracting forceps - American pattern · Tomes		D27
0120-88L	Extracting forceps - American pattern · Nevius		D27
0120-88R	Extracting forceps - American pattern · Nevius		D27
0120-101	Extracting forceps - American pattern · Hull		D27
0120-150	Extracting forceps - American pattern · Cryer		D28
0120-150S	Extracting forceps - American pattern · Cryer		D28
0120-151	Extracting forceps - American pattern · Cryer		D28

code	description	handle	page
0120-151S	Extracting forceps - American pattern · Cryer		D28
0120-222	Extracting forceps - American pattern		D28
0130-1	Extracting forceps · anatomic handle		D33
0130-2	Extracting forceps · anatomic handle		D33
0130-4	Extracting forceps · anatomic handle		D33
0130-7	Extracting forceps · anatomic handle		D33
0130-13	Extracting forceps · anatomic handle		D33
0130-17	Extracting forceps · anatomic handle		D34
0130-18	Extracting forceps · anatomic handle		D34
0130-21	Extracting forceps · anatomic handle		D34
0130-22	Extracting forceps · anatomic handle		D34
0130-33	Extracting forceps · anatomic handle		D34
0130-45	Extracting forceps · anatomic handle		D34
0130-51A	Extracting forceps · anatomic handle		D34
0130-67A	Extracting forceps · anatomic handle		D35
0130-74	Extracting forceps · anatomic handle		D35
0130-79	Extracting forceps · anatomic handle		D35
0130-86C	Extracting forceps · anatomic handle		D35
0130-89	Extracting forceps · anatomic handle		D36
0130-90	Extracting forceps · anatomic handle		D36
0130-145	Extracting forceps · anatomic handle		D36
0130-151/	Extracting forceps · anatomic handle		D36
0130-349	Extracting forceps · anatomic handle		D36
0130-359	Extracting forceps · anatomic handle		D36
0200-1	Root elevators · Bein		D47
0200-2	Root elevators · Bein		D47
0200-3	Root elevators · Bein		D47
0200-4	Root elevators · Bein		D47
0200-5	Root elevators · Bein		D47
0200-6	Root elevators · Bein		D47
0201-1	Root elevators · Flohr		D49
0201-2	Root elevators · Flohr		D49
0201-3	Root elevators · Flohr		D49
0202-320	Root elevators · Walter F. Barry		D61
0202-321	Root elevators · Walter F. Barry		D61
0202-322	Root elevators · Walter F. Barry		D61
0202-323	Root elevators · Walter F. Barry		D61
0202-350	Root elevators · Walter F. Barry		D61
0202-351	Root elevators · Walter F. Barry		D61
0202-370	Root elevators · Walter F. Barry		D61

code	description	handle	page	code	description	handle	page	code	description	handle	page	code	description	handle	page
0202-371	Root elevators · Walter F. Barry		D61	0221-A3C	Root elevators · Coupland		D56	0270-26	Root elevators · Cryer		D60	0305-1	Gum scissors · straight · Iris		C4
0203-1	Root elevators · Lecluse		D63	0222-190	Root elevators		D56	0270-44	Root elevators · Cryer		D60	0305-1TC	Gum scissors · straight · Iris		C4
0203-24	Root elevators · Pott		D63	0222-191	Root elevators		D56	0270-45	Root elevators · Cryer		D60	0305-2	Gum scissors · curved · Iris		C4
0203-25	Root elevators · Pott		D63	0223-15	Root elevators · Woodward		D56	0290-1	Root-tip picks · Heidbrink		D64	0305-2TC	Gum scissors · straight · Iris		C4
0204-11L	Root elevators · Winter		D62	0223-16	Root elevators · Woodward		D56	0290-2	Root-tip picks · Heidbrink		D64	0305-3	Gum scissors · curved · Iris		C5
0204-11R	Root elevators · Winter		D62	0228-31F	Root elevators · Friedman		D57	0290-3	Root-tip picks · Heidbrink		D64	0306-1	Gum scissors · curved, one blade serrated · Dean		C7
0204-12L	Root elevators · Winter		D62	0228-32F	Root elevators · Friedman		D57	0291-1	Root elevators · Heidbrink		D49	0306-1TC	Gum scissors · curved · Goldman-Fox		C4
0204-12R	Root elevators · Winter		D62	0229-1C	Root elevators · Coupland		D58	0291-1F	Root elevators · Mini Friedman		D57	0307-1	Gum scissors · curved, one blade serrated · La Grange		C7
0204-14L	Root elevators · Winter		D62	0229-1F	Root elevators · Friedman		D57	0291-2	Root elevators · Heidbrink		D49	0308-1	Gum scissors · straight · Quinby		C5
0204-14R	Root elevators · Winter		D62	0229-2C	Root elevators · Coupland		D58	0291-2F	Root elevators · Mini Friedman		D57	0308-2	Gum scissors · curved · Quinby		C5
0204-1L	Root elevators · Winter		D62	0229-2F	Root elevators · Friedman		D57	0291-3	Root elevators · Heidbrink		D49	0309-1	Gum scissors · straight · Kelly		C5
0204-1R	Root elevators · Winter		D62	0229-3C	Root elevators · Coupland		D58	0294-1	Root-tip picks · Warwick-James		D64	0309-1TC	Gum scissors · straight · Kelly		C5
0205-4	Root elevators · Schmeckebier-Apexo		D49	0230-11M	Root elevators · Mac Millan		D56	0294-2	Root-tip picks · Warwick-James		D64	0309-2	Gum scissors · curved · Kelly		C5
0205-4B	Root elevators · Schmeckebier-Apexo		D49	0230-12M	Root elevators · Mac Millan		D56	0294-3	Root-tip picks · Warwick-James		D64	0309-2TC	Gum scissors · curved · Kelly		C5
0205-5	Root elevators · Schmeckebier-Apexo		D49	0230-13M	Root elevators · Mac Millan		D56	0295-1	Syndesmotomes · Chompret		D65	0310-1	Gum scissors · angular, one blade serrated · Locklin		C6
0205-5B	Root elevators · Schmeckebier-Apexo		D49	0231-2	Root elevators · London Hospital		D46	0295-2	Syndesmotomes · Chompret		D65	0310-1TC	Gum scissors · angular · Locklin		C6
0206-71	Root elevators · Miller-Apexo		D52	0231-3	Root elevators · London Hospital		D46	0295-3	Syndesmotomes · Chompret		D65	0310-2	Gum scissors · angular, one blade serrated · Locklin		C6
0206-72	Root elevators · Miller-Apexo		D52	0232-1	Root elevators · Coleman		D46	0295-4	Syndesmotomes · Chompret		D65	0310-2TC	Gum scissors · angular · Locklin		C6
0206-73	Root elevators · Miller-Apexo		D52	0233-2	Root elevators		D46	0296-0	Syndesmotomes · tip		D66	0311-1	Gum scissors · straight, one blade serrated · Sullivan		C6
0206-74	Root elevators · Miller-Apexo		D52	0234-1	Root elevators · Hylin		D45	0296-1	Syndesmotomes · tip		D66	0311-2	Gum scissors · curved, one blade serrated · Sullivan		C6
0207-19	Root elevators		D52	0234-2	Root elevators · Hylin		D45	0296-2	Syndesmotomes · tip		D66	0312-1	Gum scissors · curved, sharp beaks · Westcott		C7
0207-20	Root elevators		D52	0234-3	Root elevators · Hylin		D45	0296-3	Syndesmotomes · tip		D66	0312-2	Gum scissors · curved, blunt beaks · Westcott		C7
0208-25	Root elevators · Seldin		D52	0234-4	Root elevators · Hylin		D45	0296-4	Syndesmotomes · tip		D66	0313-1	Gum scissors · curved, very thin beaks		C7
0208-35	Root elevators · Seldin		D52	0240-1	Root elevators · Bein		D48	0296-5	Syndesmotomes · tip		D66	0320-1	Gum scissors · suture · Spencer		C8
0208-34	Root elevators · Seldin		D52	0240-2	Root elevators · Bein		D48	0296-6	Syndesmotomes · tip		D66	0320-2	Gum scissors · suture · Spencer		C8
0208-34S	Root elevators · Seldin		D52	0240-3	Root elevators · Bein		D48	0296-7	Syndesmotomes · tip		D66	0321-1	Gum scissors · dissecting · straight · Metzenbaum		C8
0209-1L	Root elevators · Seldin		D53	0240-4	Root elevators · Bein		D48	0296-8	Syndesmotomes · tip		D66	0321-2	Gum scissors · dissecting · curved · Metzenbaum		C8
0209-1R	Root elevators · Seldin		D53	0240-5	Root elevators · Bein		D48	0296-9	Syndesmotomes · tip		D66	0322-1	Gum scissors · dissecting · straight · Metzenbaum-Delikat		C8
0209-4L	Root elevators · Seldin		D53	0240-6	Root elevators · Bein		D48	0296-11	Syndesmotomes · tip		D66	0322-2	Gum scissors · dissecting · curved · Metzenbaum-Delikat		C8
0209-4R	Root elevators · Seldin		D53	0241-2	Root elevators · Flohr		D58	0296-21	Syndesmotomes · tip		D66	0325-1	Gum scissors · suture · straight · Mayo		C8
0210-51	Root elevators · Curtis		D53	0241-3	Root elevators · Flohr		D58	0296-22	Syndesmotomes · tip		D67	0325-2	Gum scissors · suture · curved · Mayo		C8
0210-52	Root elevators · Curtis		D53	0242-1	Root elevators		D58	0296-23	Syndesmotomes · tip		D67	0328-1	Gum scissors · dissecting · straight · Stevens		C9
0211-11	Root elevators · Stout		D53	0242-2	Root elevators		D58	0296-24	Syndesmotomes · tip		D67	0328-2	Gum scissors · dissecting · curved · Stevens		C9
0211-11A	Root elevators · Stout		D53	0243-7	Root elevators · Cryer		D55	0296-25	Syndesmotomes · tip		D67	0329-1	Gum scissors · dissecting · rounded straight beaks · Stevens		C9
0213-12	Root elevators		D53	0243-8	Root elevators · Cryer		D55	0296-26	Syndesmotomes · tip		D67	0329-2	Gum scissors · dissecting · rounded curved beaks · Stevens		C9
0214-A	Root elevators · Cogswell		D54	0244-1	Root elevators · Kopp		D50	0296-27	Syndesmotomes · tip		D67	0330-1	Gum scissors · dissecting · straight · Stevens		C9
0215-301	Root elevators · Apexo		D54	0244-2	Root elevators · Kopp		D50	0296-28	Syndesmotomes · tip		D67	0330-2	Gum scissors · dissecting · curved · Stevens		C9
0215-302	Root elevators · Apexo		D54	0244-3	Root elevators · Kopp		D50	0296-29	Syndesmotomes · tip		D67	0335-1	Scalpel handles · orientable blade		C24
0215-303	Root elevators · Apexo		D54	0244-4	Root elevators · Kopp		D50	0296-M	Syndesmotomes · handle		D66				E9
0216-01W	Root elevators · Seldin		D54	0244-5	Root elevators · Kopp		D50	0297-1	Syndesmotomes instruments kit		D69				
0216-04W	Root elevators · Seldin		D54	0244-6	Root elevators · Kopp		D50	0300-1	Gum scissors · straight		C3				
0217-1	Root elevators · Heidbrink		D54	0250-1	Root elevators · Bein		D59	0300-2	Gum scissors · curved		F45				
0217-2	Root elevators · Heidbrink		D54	0250-2	Root elevators · Bein		D59				K28				
0217-40	Root elevators · Heidbrink		D54	0250-3	Root elevators · Bein		D59	0301-1	Gum scissors · angular		C3				
0217-41	Root elevators · Heidbrink		D54	0250-4	Root elevators · Bein		D59	0301-2	Gum scissors · angular, one blade serrated		C3				
0218-1	Root elevators		D51	0250-5	Root elevators · Bein		D59	0302-1	Gum scissors · curved · Neumann		C7				
0218-2	Root elevators		D51	0250-6	Root elevators · Bein		D59	0303-1	Gum scissors · curved, very thin beaks · Noyes (Castroviejo)		C7				
0218-3	Root elevators		D51	0251-1	Root elevators · Flohr		D59	0304-1	Gum scissors · straight, one blade serrated · Goldman-Fox		C3				
0218-4	Root elevators		D51	0251-2	Root elevators · Flohr		D59	0304-1TC	Gum scissors · straight · Goldman-Fox		C4				
0218-81A	Root elevators		D56	0251-3	Root elevators · Flohr		D59	0304-2	Gum scissors · curved, one blade serrated · Goldman-Fox		C3				
0219-1	Root elevators		D51	0255-4	Root elevators · Schmeckebier-Apexo		D59	0304-2TC	Gum scissors · curved · Goldman-Fox		E4				
0219-2	Root elevators		D51	0255-5	Root elevators · Schmeckebier-Apexo		D59	0304-3	Gum scissors · curved, one blade serrated · Goldman-Fox (special)		C4				
0220-25	Root elevators · Cryer		D55	0256-71	Root elevators · Miller-Apexo		D60								
0220-26	Root elevators · Cryer		D55	0256-72	Root elevators · Miller-Apexo		D60								
0220-31	Root elevators · Cryer		D55	0259-4L	Root elevators · Seldin		D60								
0220-32	Root elevators · Cryer		D55	0259-4R	Root elevators · Seldin		D60								
0220-44	Root elevators · Cryer		D55	0265-301	Root elevators · Apexo		D60								
0220-45	Root elevators · Cryer		D55	0266-01W	Root elevators · Seldin		D60								
0221-A1C	Root elevators · Coupland		D56	0267-1	Root elevators · Heidbrink		D60								
0221-A2C	Root elevators · Coupland		D56	0267-2	Root elevators · Heidbrink		D60								
				0267-41	Root elevators · Heidbrink		D60								
				0270-25	Root elevators · Cryer		D60								

code	description	handle	page	code	description	handle	page	code	description	handle	page	code	description	handle	page
0350-3	Scalpel handles · double cutting edge		C26 E7	0416-15TC	Needle holders · Mini-Ryder		C13	0480-4	Syringes · cork screw tip, metric thread		C29	0498-2C5	Osteotomes		E18
0350-3G	Scalpel handles		C26 E7	0416-18TC	Needle holders · Mini-Ryder		C13	0480-4W	Syringes · cork screw tip, imperial thread (Withworth)		C29	0498-30B3	Osteotomes		E18
0350-5	Scalpel handles		C26 E8	0417-15TC	Needle holders · Fine Swedish		C14	0480-5	Syringes · self-aspirating, metric thread		C28	0498-30B33	Osteotomes		E18
0350-5A	Scalpel handles		C26 E8	0418-15TC	Needle holders · Micro-Vascular		C14	0480-6	Syringes · self-aspirating, metric thread		C28	0498-30B4	Osteotomes		E18
0350-7	Scalpel handles		C26 E7	0419-16TC	Needle holders · scissors combined · Gillies		C14	0480-P1	Syringes · spare caps for syringe, metric thread		C29	0498-30B5	Osteotomes		E18
0350-8	Scalpel handles		C26 E7	0420-16	Needle holders · Mayo-Hegar		C12	0480-P2	Syringes · spare caps for syringe, imperial thread (Withworth)		C29	0498-PF3	Osteotomes		E18
0351-10	Scalpel blades		C26 E8	0420-18	Needle holders · Mayo-Hegar		C12	0481-7	Syringes · intra-ligamental, metric thread		C30	0498-PF33	Osteotomes		E18
0351-11	Scalpel blades		C26 E8	0421-18	Needle holders · light pattern · Toennis		C14	0481-8	Syringes · intra-ligamental, metric thread		C30	0498-PF4	Osteotomes		E18
0351-12	Scalpel blades		C26 E8	0422-19	Needle holders · Eiselberg-Mathieu		C15	0481-T1	Syringes · autoclavable plastic protection sleeve		C30	0498-PF5	Osteotomes		E18
0351-12D	Scalpel blades · double cutting edge		C26 E8	0425-16TC	Needle holders · Mayo-Hegar		C12	0482-1	Syringes · syringes stand		C30	0500-1	Hemostats · straight · Halstead-Mosquito		C21 F44
0351-13	Scalpel blades		C26 E8	0425-18TC	Needle holders · Mayo-Hegar		C12	0482-3W	Syringes · non self-aspirating, imperial thread (Withworth)		C28	0500-2	Hemostats · curved · Halstead-Mosquito		C21
0351-15	Scalpel blades		C26 E8	0426-18TC	Needle holders · light pattern · Toennis		C14	0482-4W	Syringes · non self-aspirating, imperial thread (Withworth)		C28	0501-1	Hemostats · straight · Micro-Mosquito		C22 F44
0351-15C	Scalpel blades		C26 E8	0430-14	Needle holders · Mathieu		C16	0482-6W	Syringes · self-aspirating, imperial thread (Withworth)		C28	0501-2	Hemostats · curved · Micro-Mosquito		C22
0352	Scalpel blade remover		C24 E9	0430-17	Needle holders · Mathieu		C16	0482-7W	Syringes · intra-ligamental, imperial thread (Withworth)		C30	0505-1	Hemostats · straight · Halstead-Mosquito 1x2		C21
0360-4	Scalpel handles		C27	0431-14	Needle holders · Mathieu		C16	0483-1	Syringes · self-aspirating, metric thread		C28	0505-2	Hemostats · curved · Halstead-Mosquito 1x2		C21
0361-20	Scalpel blades		C27	0432-14	Needle holders · scissors combined · Mathieu		C16	0483-2	Syringes · non self-aspirating, metric thread		C28	0506-1	Hemostats · straight · Micro-Mosquito 1x2		C22
0361-21	Scalpel blades		C27	0432-14TC	Needle holders · Mathieu		C16	0483-3	Syringes · non self-aspirating, metric thread		C28	0506-2	Hemostats · curved · Micro-Mosquito 1x2		C22
0361-22	Scalpel blades		C27	0432-17	Needle holders · smooth action · Lichtenberg		C15	0490-1	Bone injector		E27	0507-1	Elastic forceps · straight · Halstead-Mosquito		H36
0361-23	Scalpel blades		C27	0433-16	Needle holders · Arruga		C15	0490-2	Bone injector		E27	0507-2	Elastic forceps · curved · Halstead-Mosquito		H36
0361-24	Scalpel blades		C27	0435-14TC	Needle holders · Mathieu		C17 E5	0491-1	Bone thickness gauge		E31	0510-1	Hemostats · straight · Kelly		C23 F44
0365-1	Micro-blades		C27	0435-17TC	Needle holders · Mathieu		C17 E5	0491-2	Bone thickness gauge		E31	0510-2	Hemostats · curved · Kelly		C23
0366-4	Micro-blades		C27 E9	0436-14TC	Needle holders · Mathieu		C17	0493-1	Aspirators		E33	0515-1	Hemostats · straight · Hartmann		C23
0366-7	Micro-blades		C27 E9	0436-17TC	Needle holders · Mathieu		C17 C15	0493-2	Filter for aspirators		E33	0515-2	Hemostats · curved · Hartmann		C23
0371-10	Disposable scalpels		C25 E10	0437-17TC	Needle holders · Lichtenberg		E5	0493-5	Aspirators		E33	0520-1	Hemostats · straight · Crile		C20
0371-11	Disposable scalpels		C25 E10	0438-16TC	Needle holders · Arruga		C15	0494-1	Bone scraper · straight		E28	0520-2	Hemostats · curved · Crile		C20
0371-12	Disposable scalpels		C25 E10	0440-14	Needle holders · Castroviejo		C18	0494-2R	Bone scraper · straight		E28	0530-1	Hemostats · straight · Kocher 1x2		C20
0371-15	Disposable scalpels		C25 E10	0440-18	Needle holders · Castroviejo		C19	0495-1	Osteotomes		E19	0530-2	Hemostats · curved · Kocher 1x2		C20
0400-14	Needle holders · scissors combined · Olsen-Hegar		C10	0441-14	Needle holders · with curved jaws · Castroviejo		C18	0495-2	Osteotomes		E19	0540-1	Hemostats · straight · Pean		C20
0401-12	Needle holders · Derf		C13	0441-18	Needle holders · with curved jaws · Castroviejo		C19	0495-3	Osteotomes		E19	0540-2	Hemostats · curved · Pean		C20
0403-17	Needle holders · Adson		C10	0442-13	Needle holders · Castroviejo		C19	0495-4	Osteotomes		E19	0545-1	Crown instruments		K29
0404-14	Needle holders · Baumgartner		C11	0442-13L	Needle holders · smooth jaws · Castroviejo		C19	0495-5	Osteotomes		E19	0550-1	Towel clamps · Backhaus		C31
0405-14TC	Needle holders · Olsen-Hegar		C10	0443-14	Needle holders · Castroviejo		C18	0495-6	Osteotomes		E19	0550-2	Towel clamps · Backhaus		C31
0406-12TC	Needle holders · Derf		C13	0444-12L	Needle holders · smooth jaws · Castroviejo-Barraquer		C18	0496-1P	Osteotomes		E20	0550-3	Towel clamps · Backhaus		C31
0407-13TC	Needle holders · smooth jaws · Halsey-Smooth		C13	0445-14TC	Needle holders · Castroviejo		E5	0496-2P	Osteotomes		E20	0555-1	Dressing forceps · straight · Gross-Maier		C32
0408-13TC	Needle holders · Halsey		C13	0445-18TC	Needle holders · Castroviejo		C19	0496-3P	Osteotomes		E20	0555-2	Dressing forceps · curved · Gross-Maier		C32
0409-14TC	Needle holders · Hegar-Baumgartner		C11	0446-14TC	Needle holders · Castroviejo		E5	0496-4P	Osteotomes		E20	0557-1	Dressing forceps · straight · Gross-Maier		C32
0410-15	Needle holders · Crile-Wood		C10	0446-18TC	Needle holders · Castroviejo		C19	0497-1T	Osteotomes		E20	0557-2	Dressing forceps · curved · Gross-Maier		C32
0414-16	Needle holders · scissors combined · Gillies		C14	0447-13TC	Needle holders · Castroviejo		C19	0497-2T	Osteotomes		E20	0561-R	Tongue forceps		C33
0415-15TC	Needle holders · Crile-Wood		C10	0448-14TC	Needle holders · Castroviejo		C18	0497-3T	Osteotomes		E20	0565-1	Sterilizing forceps		I13
				0450-18TC	Needle holders · Micro-Barraquer		C17 E6	0498-1B3	Osteotomes		E18	0565-2	Sterilizing forceps		I13
				0451-18TC	Needle holders · with curved jaws · Micro-Barraquer		C17 E6	0498-1B4	Osteotomes		E18	0560	Tongue forceps · Collin		C33
				0480-1	Syringes · cork screw tip, metric thread		C29	0498-1B5	Osteotomes		E18	0561	Tongue forceps · Young		C33
				0480-2	Syringes · cork screw tip, metric thread		C29	0498-2C3	Osteotomes		E18	0600-17	Cotton and dressing pliers		B5
				0480-3	Syringes · cork screw tip, metric thread		C29	0498-2C33	Osteotomes		E18	0600-18	Cotton and dressing pliers		B5
								0498-2C4	Osteotomes		E18	0600-18L	Cotton and dressing pliers · Locking		B3
												0600-19	Cotton and dressing pliers		B5
												0600-2	Cotton and dressing pliers · London-College		B4
												0600-3	Cotton and dressing pliers		B5

code	description	handle	page	code	description	handle	page	code	description	handle	page	code	description	handle	page
0600-4	Cotton and dressing pliers · Perry		B4	0691	Ultralight Retractors		B21	0705L-17W	Combination Explorers - Probes · Williams	Asa60	B11	1015-3	Amalgam carriers · medium/jumbo		F20
0601-1	Cotton and dressing pliers · Flagg		B4	0700-10	Single-ended Explorers	Asa60	B6	0705L-23GF	Combination Explorers - Probes · Goldman-Fox	Asa60	B10	1020-1	Amalgam carriers · straight		F21
0601-2	Cotton and dressing pliers · London-College		B4	0700-11	Single-ended Explorers	Asa60	B6	0705L-23UM	Combination Explorers - Probes · University of Michigan	Asa60	B10	1020-2	Amalgam carriers · 45°		F21
0601-3	Cotton and dressing pliers · Meriam		B4 K19	0700-12	Single-ended Explorers	Asa60	B6	0705L-23W	Combination Explorers - Probes · Williams	Asa60	B10	1020-2P	Amalgam carriers		F21
0601-4	Cotton and dressing pliers · Perry		B4	0700-16	Single-ended Explorers	Asa60	B6	0705L-3GF	Root-canal Explorers · Goldman-Fox	Asa60	B10	1020-3	Amalgam carriers · 90°		F21
0601-5	Cotton and dressing pliers · Perry		B4	0700-17	Single-ended Explorers	Asa60	B6	0706L-2311	Combination Explorers - Probes	Asa60	B10	1021-1	Amalgam carriers · straight, autoclavable plastic		F21
0602-1	Cotton and dressing pliers		B3	0700-17A	Single-ended Explorers	Asa60	B6	0706L-2312	Combination Explorers - Probes	Asa60	B11	1021-1P	Amalgam carriers · straight spare tip, autoclavable plastic		F21
0602-2	Cotton and dressing pliers		B3	0700-2	Single-ended Explorers	Asa60	B5	0707L-GFW	Combination Explorers - Probes · Goldman-Fox Williams	Asa60	B11	1021-2	Amalgam carriers · 45°, autoclavable plastic		F21
0620-1	Tissue pliers · Adson		C38 E36	0700-23	Single-ended Explorers	Asa60	B6	0708-1N	Double ended Explorers · Nabers	Asa60	B11	1021-2P	Amalgam carriers · 45° spare tip, autoclavable plastic		F21
0621-1	Tissue pliers · Adson 1x2		C38 E36	0700-3	Single-ended Explorers	Asa60	B6	0708-2N	Double ended Explorers · Nabers	Asa60	B11	1021-3	Amalgam carriers · 90°, autoclavable plastic		F21
0622-1	Tissue pliers · Micro-Adson 1x2		C38	0700-3A	Single-ended Explorers	Asa60	B6	0708L-2N	Double ended Explorers · Nabers	Asa60	B11	1021-3P	Amalgam carriers · 90° spare tip, autoclavable plastic		F21
0622-2	Tissue pliers · Micro-Adson 1x2		C39	0700-3R	Single-ended Explorers · Rhein	Asa60	B6	0709-2	Double ended Explorers	Asa60	B8	1030-1	Amalgam wells		F20
0623-1	Tissue pliers		C39	0700-5	Single-ended Explorers	Asa60	B6	0709-2A	Double ended Explorers	Asa60	B8	1030-2	Amalgam wells		F20
0624-1	Tissue pliers · Micro-Adson		C39	0700-6	Single-ended Explorers	Asa60	B6	0709-3	Double ended Explorers	Asa60	B9	1030-3	Amalgam wells		F20
0624-2	Tissue pliers · Micro-Adson		C39	0700-8	Single-ended Explorers	Asa60	B6	0710-6D1	Root-canal Explorers	Asa60	B9	1030-4	Bone well		E32
0625-1	Suture pliers		C40	0700-9	Single-ended Explorers	Asa60	B6	0710-6D2	Root-canal Explorers	Asa60	B9	1100-1	Separating spatulas · Heidemann	Octagonal	F23
0626-1	Tissue pliers · non traumatic · Adson Brown		C41	0701-10	Single-ended Explorers	Asa60M	B6	0710-6D3	Root-canal Explorers	Asa60	B9	1100-2	Separating spatulas · Heidemann	Octagonal	F23
0630-1	Tissue pliers · Semken-Taylor		C41 E36	0701-11	Single-ended Explorers	Asa60M	B6	0800	Ruler for endodontic		B15	1100-3	Separating spatulas · Heidemann	Octagonal	F23
0630-2	Tissue pliers · Semken-Taylor		C41 E36	0701-12	Single-ended Explorers	Asa60M	B6	0800-1	Root-canal Spreaders	Asa60	B12	1101-1	Separating spatulas · Heidemann	Asa60	F23
0631-1	Tissue pliers · Semken-Taylor 1x2		C41	0701-16	Single-ended Explorers	Asa60M	B6	0800-2	Root-canal Spreaders	Asa60	B12	1101-2	Separating spatulas · Heidemann	Asa60	F23
0631-2	Tissue pliers · Semken-Taylor 1x2		C41	0701-17	Single-ended Explorers	Asa60M	B6	0800-3	Root-canal Spreaders	Asa60	B12	1101-3	Separating spatulas · Heidemann	Asa60	F23
0635-1	Tissue pliers		C43	0701-17A	Single-ended Explorers	Asa60M	B6	0800-4	Root-canal Spreaders	Asa60	B12	1102-1	Separating spatulas · Heidemann	Asa60	F24
0635-2	Tissue pliers		C43	0701-2	Single-ended Explorers	Asa60M	B6	0800-5	Root-canal Spreaders	Asa60	B12	1102-2	Separating spatulas · Heidemann	Asa60	F24
0635-3	Tissue pliers		C43 K19	0701-23	Single-ended Explorers	Asa60M	B6	0800-6	Root-canal Spreaders	Asa60	B12	1102-3	Separating spatulas · Heidemann	Asa60	F24
0635-4	Tissue pliers		C43 K19	0701-3	Single-ended Explorers	Asa60M	B6	0800-7	Root-canal Spreaders	Asa60	B12	1102T-1	Separating spatulas · Titanium nitride coating · Heidemann	Asa60	F24
0635-5	Tissue pliers		C43	0701-3A	Single-ended Explorers	Asa60M	B6	0801-1	Root-canal Pluggers · Luks	Asa60	B13	1102T-2	Separating spatulas · Titanium nitride coating · Heidemann	Asa60	F24
0635-6	Laboratory tweezers		K19	0701-5	Single-ended Explorers	Asa60M	B6	0801-2	Root-canal Pluggers	Asa60	B13	1102T-3	Separating spatulas · Titanium nitride coating · Heidemann	Asa60	F24
0645-1	Tissue pliers		C42	0701-6	Single-ended Explorers	Asa60M	B6	0801-3	Root-canal Pluggers · Luks	Asa60	B13	1200-1	Filling instruments - amalgam	Asa60	F26
0645-2	Tissue pliers		C42 K19	0701-8	Single-ended Explorers	Asa60M	B6	0801-4	Root-canal Pluggers · Luks	Asa60	B13	1200-2	Filling instruments - amalgam	Asa60	F26
0645-3	Tissue pliers		C42 K19	0701-9	Single-ended Explorers	Asa60M	B6	0802L-1	Vertical condensers	Asa60	B15	1200-3	Filling instruments - amalgam	Asa60	F26
0645-4	Tissue pliers		C42	0702-C	Periodontal pocket Probes	Asa35	G3	0802L-2	Vertical condensers	Asa60	B15	1200-4	Filling instruments - amalgam	Asa60	F26
0645-5	Tissue pliers		C42	0702L-11	Periodontal pocket Probes	Asa60	E32 G3	0802L-3	Vertical condensers	Asa60	B15	1200-5	Filling instruments - amalgam	Asa60	F26
0650-1	Periodontal pocket markers · Goldman-Fox (Crane-Kaplan)		B3 E35 G31	0702L-12	Periodontal pocket Probes	Asa60	E32 G3	0802L-4	Vertical condensers	Asa60	B15	1200T-1	Filling instruments - amalgam · Titanium nitride coating	Asa60	F25
0650-2	Periodontal pocket markers · Goldman-Fox (Crane-Kaplan)		B3 E35 G31	0702L-12S	Periodontal pocket Probes	Asa60	E32 G3	0870-1	Pliers for removing broken broaches		B16	1200T-2	Filling instruments - amalgam · Titanium nitride coating	Asa60	F25
0660-1	Membrane holding tweezers		E37	0702L-15	Periodontal pocket Probes	Asa60	G3	0870-2	Pliers for removing broken broaches		B16	1200T-3	Filling instruments - amalgam · Titanium nitride coating	Asa60	F25
0660-2	Membrane holding tweezers · with delicate ring tips		E37	0703L-1	Periodontal pocket Probes · Williams	Asa60	G3	0900-1	Cement spatulas		F22	1201-1	Filling instruments - amalgam	Asa60	F26
0661-1	Implant holding tweezers		E37	0703L-2	Periodontal pocket Probes · Merrit A	Asa60	G3	0900-2	Cement spatulas		F22	1201-1L	Filling instruments - amalgam · Asa Com 9/9B	Asa60	F49
0661-2	Implant holding tweezers		E37	0703L-3	Periodontal pocket Probes · Merrit B	Asa60	G3	0903-0	Cement spatulas		F22	1201-2	Filling instruments - amalgam	Asa60	F26
0661-3	Implant holding tweezers		E37	0703L-4	Periodontal pocket Probes · Goldman-Fox	Asa60	G3	0903-00	Cement spatulas		F22	1201-2L	Filling instruments - amalgam · Asa Com 10/10B	Asa60	F49
0670	Articulating paper forceps · Miller		F42	0703L-5	Periodontal pocket Probes · University of Michigan	Asa60	G3	0903-1	Cement spatulas		F22	1201-3	Filling instruments - amalgam	Asa60	F26
0671	Articulating paper forceps		F42	0703L-6	Periodontal pocket Probes	Asa60	G3	0903-2	Cement spatulas		F22	1201-3L	Filling instruments - amalgam	Asa60	F26
0680	Towel clamps · Schaedle		C31	0704-11/12AF	Double ended Explorers	Asa60	B8	0903-3	Cement spatulas		F22	1202-1	Filling instruments - amalgam	Asa60	F27
0681	Towel clamps · Jones		C31	0704-16D1	Double ended Explorers	Asa60	B8	0903-4	Cement spatulas		F22	1202-1L	Filling instruments - amalgam	Asa60	F27
0690	Ultralight Mirrors		B21	0704-16D2	Double ended Explorers · Asa Com 2/2B	Asa60	B8 F48	0999-1	Glass plate		F22	1202-2	Filling instruments - amalgam	Asa60	F27
0690-G	Ultralight Mirrors		B21	0704-23D1	Double ended Explorers	Asa60	B8	1009-1	Amalgam carriers · straight for retrograds		F21	1202-2L	Filling instruments - amalgam	Asa60	F27
0690-L	Ultralight Mirrors		B21	0704-23D2	Double ended Explorers	Asa60	B8	1009-2	Amalgam carriers · curved for retrograds		F21	1202-3	Filling instruments - amalgam	Asa60	F27
0690-M	Ultralight Mirrors		B21	0704-6D9	Double ended Explorers	Asa60	B8	1009-3	Amalgam carriers · straight for retrograds		F21	1202-3L	Filling instruments - amalgam	Asa60	F27
0690-T	Ultralight Mirrors		B21	0704-UT1	Double ended Explorers · Cattoni	Asa60	B8	1009-4	Amalgam carriers · curved for retrograds		F21	1202-4	Filling instruments - amalgam	Asa60	F27
				0705L-16GF	Combination Explorers - Probes · Goldman-Fox	Asa60	B10	1011-1	Amalgam carriers · small		F20	1202-4L	Filling instruments - amalgam	Asa60	F27
				0705L-16W	Combination Explorers - Probes · Williams	Asa60	B10	1011-2	Amalgam carriers · medium		F20				
				0705L-17GF	Combination Explorers - Probes · Goldman-Fox	Asa60	B10	1011-3	Amalgam carriers · large		F20				
				0705L-17UM	Combination Explorers - Probes · University of Michigan	Asa60	B10	1011-4	Amalgam carriers · jumbo		F20				
								1015-1	Amalgam carriers · medium/small		F20				
								1015-2	Amalgam carriers · medium/large		F20				

code	description	handle	page	code	description	handle	page	code	description	handle	page	code	description	handle	page
1202T-1	Filling instruments - amalgam · Titanium nitride coating	Asa60	F25	1214-3	Filling instruments - Burnishers · Ladmore	Asa60	F31	1401-2	Filling instruments - amalgam · Foc	Asa60	F30	1705-18	Excavators - spoons	Asa60	F14
1202T-2	Filling instruments - amalgam · Titanium nitride coating	Asa60	F25	1214-A	Filling instruments - Burnishers	Asa60	F31	1401-2S	Filling instruments - amalgam · Foc	Asa60	F30	1705-18W	Excavators - oval spoons	Asa60	F15
1203-1	Filling instruments - amalgam · Asa Com 3/3B	Asa60	F27 F48	1215-18	Filling instruments - Burnishers · Ball	Asa60	F31	1500-02	Amalgam/wax carvers · Hollenback	Asa60	F36 K13	1706-19	Excavators - spoons	Asa60	F14
1203-2	Filling instruments - amalgam	Asa60	F27	1215-27S	Filling instruments - Burnishers · Ball	Asa60	F31	1500-3	Amalgam/wax carvers · Hollenback	Asa60	F36 K13	1706-19W	Excavators - oval spoons	Asa60	F15
1203-3	Filling instruments - amalgam · Asa Com 4/4B	Asa60	F27 F48	1215-29	Filling instruments - Burnishers · Ball	Asa60	F31	1500-3S	Amalgam/wax carvers · Hollenback	Asa60	F36 K13	1707-39	Excavators - spoons	Asa60	F14
1204-1	Filling instruments - Burnishers · Westcott	Asa60	F31	1215-W3	Filling instruments - Burnishers	Asa60	F31	1501-1	Amalgam/wax carvers · Ward	Asa60	F36 K13	1709-31L	Root-canal Excavators	Asa60	B15 F14
1204-2	Filling instruments - Burnishers · Westcott	Asa60	F31	1216-1	Filling instruments - plastic · Woodson	Asa60	F35	1501-1S	Amalgam/wax carvers · Ward	Asa60	F36 K13	1709-32L	Root-canal Excavators	Asa60	B15 F14
1204T-1	Filling instruments - amalgam · Titanium nitride coating · Westcott	Asa60	F25	1216-2	Filling instruments - plastic · Woodson	Asa60	F35	1501-2	Amalgam/wax carvers · Ward	Asa60	F36 K13	1710-14	Excavators · SS. White	Asa60	F16
1205-1	Filling instruments - amalgam · Ward	Asa60	F28	1216-3	Filling instruments - plastic · Woodson	Asa60	F35	1502-1	Amalgam/wax carvers · Frahm	Asa60	F37 K13	1710-17	Excavators · SS. White	Asa60	F16
1205-2	Filling instruments - amalgam · Ward	Asa60	F28	1217-11	Filling instruments - plastic	Asa60	F35	1503-2	Amalgam/wax carvers · USC	Asa60	F37 K13	1710-18	Excavators · SS. White	Asa60	F16
1206-1	Filling instruments - plastic	Asa60	F34	1218-6	Filling instruments - plastic	Asa60	F35	1504-1	Amalgam carvers · Interproximal	Asa60	F37	1710-19	Excavators · SS. White	Asa60	F16
1206-2	Filling instruments - plastic	Asa60	F34	1219-179	Filling instruments - plastic · Asa Com 5/5B	Asa60	F48	1504-2	Amalgam carvers · Interproximal Off-angle · Asa Com 6/6B	Asa60	F48	1710-20	Excavators · SS. White	Asa60	F16
1207-1	Filling instruments - plastic	Asa60	F34	1220-1	Composite instruments · Felt	Alu60	F32	1505-3	Amalgam carvers	Asa60	F37	1710-5	Excavators · SS. White	Asa60	F16
1207-2	Filling instruments - plastic	Asa60	F34	1220-2	Composite instruments · Felt	Alu60	F32	1505-A	Amalgam carvers	Asa60	F37	1711-1	Excavators · Darby-Perry	Asa60	F17
1208-1	Filling instruments - plastic	Asa60	F34	1220-3	Composite instruments · Felt	Alu60	F32	1506-104	Amalgam carvers	Asa60	F37	1711-11	Excavators · Darby-Perry	Asa60	F17
1208-2	Filling instruments - plastic	Asa60	F34	1220-4	Composite instruments · Felt	Alu60	F32	1507-8	Amalgam carvers · Wiland	Asa60	F37	1711-12	Excavators · Darby-Perry	Asa60	F17
1208-3	Filling instruments - plastic	Asa60	F34	1220-5	Composite instruments · Felt	Alu60	F32	1600-1	Amalgam carvers · cleoid-discoid	Asa60	F38	1711-2	Excavators · Darby-Perry	Asa60	F17
1208T-1	Filling instruments - plastic · Titanium nitride coating	Asa60	F33	1220-6	Composite instruments · Felt	Alu60	F32	1600-2	Amalgam carvers · cleoid-discoid	Asa60	F38	1711-21	Excavators · Darby-Perry	Asa60	F17
1208T-2	Filling instruments - plastic · Titanium nitride coating	Asa60	F33	1220-B2	Filling instruments - Burnishers · Asa Com 8/8B · New York Univeristy	Asa60	F49	1600-3	Amalgam carvers · cleoid-discoid	Asa60	F38	1711-22	Excavators · Darby-Perry	Asa60	F17
1208T-3	Filling instruments - plastic · Titanium nitride coating	Asa60	F33	1221-31	Filling instruments - Burnishers	Asa60	F31	1600-4	Amalgam carvers · cleoid-discoid	Asa60	F38	1711-243	Excavators - ASH	Asa60	F15
1209-1	Filling instruments - plastic	Asa60	F34	1300	Placement instruments	Asa35	F39	1601-1	Cavity preparation instruments - margin trimmers · distal · Black/26	Asa60	F18	1711-31	Excavators · Darby-Perry	Asa60	F17
1209-2	Filling instruments - plastic	Asa60	F34	1301	Placement instruments	Asa60	F39	1601-2	Cavity preparation instruments - margin trimmers · mesial · Black/27	Asa60	F19	1711-32	Excavators · Darby-Perry	Asa60	F17
1209-3	Filling instruments - plastic	Asa60	F34	1302	Placement instruments	Asa60	F39	1601-3	Cavity preparation instruments - margin trimmers · distal · Black/28	Asa60	F19	1711-41	Excavators · Darby-Perry	Asa60	F17
1209T-2	Filling instruments - plastic · Titanium nitride coating	Asa60	F33	1303	Medication instruments · Orban Loop	Octagonal	F39	1601-4	Cavity preparation instruments - margin trimmers · mesial · Black/29	Asa60	F19	1711-42	Excavators · Darby-Perry	Asa60	F17
1210-1	Composite instruments · Asa Com 14/14B	Asa60	F35 F50	1310-1	Instruments for retractor wire	Asa60	F38	1602-1	Cavity preparation instruments - margin trimmers · distal · Black/77-78	Asa60	F19	1711-G2	Excavators · ASH	Asa60	F15
1210-2	Filling instruments - plastic	Asa60	F35	1310-2	Instruments for retractor wire	Asa60	F38	1602-2	Cavity preparation instruments - margin trimmers · mesial · Black/79-80	Asa60	F19	1800-1	Bone chisels and gouges · Ochsenbein		G27
1210-3	Filling instruments - plastic · Asa Com 15/15B	Asa60	F35 F50	1350-1	Ligature Instruments · band seating and removing instrument		H35	1603-1	Cavity preparation instruments - hatchets · Black/53-54	Asa60	F18	1800-2	Bone chisels and gouges · Ochsenbein		G27
1210T-2	Filling instruments - plastic · Titanium nitride coating	Asa60	F33	1350-2	Ligature Instruments · band seating and removing instrument		H35	1603-2	Cavity preparation instruments - hatchets · Black/51-52	Asa60	F18	1801-1	Chisels · TG	Asa60	G26
1211-0T	Filling instruments - amalgam · Tanner	Asa60	F28	1351-1	Ligature Instruments · band seating and removing instrument		H35	1603-2	Cavity preparation instruments - hatchets · Black/51-52	Asa60	F18	1801-2	Chisels · TG	Asa60	G26
1211-1T	Filling instruments - amalgam · Tanner	Asa60	F28	1352-1	Elastic instruments		H35	1604-02	Cavity preparation instruments - chisels · Wedelstaet	Asa60	F18	1801-D	Chisels · TG	Asa60	G26
1211-2T	Filling instruments - amalgam · Tanner	Asa60	F28	1355-1	Gauze packers · ligature and archwire tucker · Luniatschek	Octagonal	F39	1604-04	Cavity preparation instruments - chisels · Wedelstaet	Asa60	F18	1802-3	Chisels · Ochsenbein	Asa60	G26
1211-3T	Filling instruments - amalgam · Tanner	Asa60	F28	1355-2	Gauze packers · ligature and archwire tucker · Luniatschek	Octagonal	F39	1604-06	Cavity preparation instruments - chisels · Wedelstaet	Asa60	F18	1802-4	Chisels · Ochsenbein	Asa60	G26
1212-01	Filling instruments - amalgam · Marquette	Asa60	F28	1400-1	Filling instruments - amalgam · Markley	Asa60	F29	1700-0	Excavators - spoons	Asa60	F13	1803-1	Gingivectomy knives · Kirkland	Asa60	G24
1213-H1	Filling instruments - amalgam · Hollenback	Asa60	F28	1400-2	Filling instruments - amalgam · Markley	Asa60	F29	1700-1	Excavators - spoons	Asa60	F13	1803-2	Gingivectomy knives · Kirkland	Asa60	G24
1213-H2	Filling instruments - amalgam · Hollenback	Asa60	F28	1400-3	Filling instruments - amalgam · Markley	Asa60	F29	1700-2	Excavators - spoons	Asa60	F13	1803-D	Gingivectomy knives · Kirkland	Asa60	G24
1213-H3	Filling instruments - amalgam · Asa Com 12/12B · Hollenback	Asa60	F28 F49	1400-4	Filling instruments - amalgam · Markley	Asa60	F29	1700-3	Excavators - spoons	Asa60	F13	1804-1	Gingivectomy knives · Orban	Asa60	G24
1213-H4	Filling instruments - amalgam · Hollenback	Asa60	F28	1400-5	Filling instruments - amalgam · Markley	Asa60	F29	1700-4	Excavators - spoons	Asa60	F13	1804-2	Gingivectomy knives · Orban	Asa60	G24
1214-2	Filling instruments - Burnishers · Ladmore	Asa60	F31	1400-6	Filling instruments - amalgam · Markley	Asa60	F29	1701-1	Excavators - spoons	Asa60	F13	1804-D	Gingivectomy knives · Orban	Asa60	G24
				1401-0	Filling instruments - amalgam · Foc	Asa60	F30	1701-2	Excavators - spoons	Asa60	F13	1805-02	Curettes and Scalers · Langer	Asa60	G5
				1401-0S	Filling instruments - amalgam · Foc	Asa60	F30	1702-6	Excavators - spoons	Asa60	F14	1805-04	Curettes and Scalers · Langer	Asa60	G5
				1401-1	Filling instruments - amalgam · Asa Com 11/11B · Foc	Asa60	F49	1703-14	Excavators - spoons	Asa60	F14	1806-02	Curettes and Scalers	Asa60	G4
				1401-1S	Filling instruments - amalgam · Foc	Asa60	F30	1704-17	Excavators - spoons	Asa60	F14	1806-14	Curettes and Scalers · Columbia	Asa60	G4
								1704-17W	Excavators - oval spoons	Asa60	F15	1806-2RL	Curettes and Scalers · Columbia	Asa60	G4
												1806-412	Curettes and Scalers · Columbia	Asa60	G4
												1806-414	Curettes and Scalers · Columbia	Asa60	G4
												1806-4RL	Curettes and Scalers · Columbia	Asa60	G4
												1807-02	Gracey curettes · Gracey	Asa60	G11
												1807-02AF	Gracey curettes - AF · Gracey	Asa60	G12
												1807-02MF	Gracey curettes - MF · Gracey	Asa60	G13
												1807-04	Gracey curettes · Gracey	Asa60	G11
												1807-04AF	Gracey curettes - AF · Gracey	Asa60	G12
												1807-04MF	Gracey curettes - MF · Gracey	Asa60	G13
												1807-06	Gracey curettes · Gracey	Asa60	G11
												1807-06AF	Gracey curettes - AF · Gracey	Asa60	G12
												1807-06MF	Gracey curettes - MF · Gracey	Asa60	G13
												1807-08	Gracey curettes · Gracey	Asa60	G11
												1807-08AF	Gracey curettes - AF · Gracey	Asa60	G12
												1807-08MF	Gracey curettes - MF · Gracey	Asa60	G13

code	description	handle	page	code	description	handle	page	code	description	handle	page	code	description	handle	page
1807-10	Gracey curettes · Gracey	Asa60	G11	1831-32	Curettes and Scalars · Jacquette	Asa60	G9	1858-1	Periosteals and Elevators · König		E25	2013-2L	Bone curettes · U.S.A. model		G21
1807-11MD	Gracey curettes · Mesial-Distal · Gracey	Asa60	G11	1831-33	Curettes and Scalars · Jacquette	Asa60	G9	G18			G18	2013-2R	Bone curettes · U.S.A. model		G21
1807-12	Gracey curettes · Gracey	Asa60	G11	1831-35	Curettes and Scalars · Jacquette	Asa60	G9	1870-1	Mouth gags · Molt		C33	2014-3	Bone curettes		C45
1807-12AF	Gracey curettes · AF · Gracey	Asa60	G12	1831-38	Curettes and Scalars · Jacquette	Asa60	G9	1870-2	Mouth gags · Molt		C33				E21
1807-12MF	Gracey curettes · MF · Gracey	Asa60	G13	1832-1	Bone chisels and gouges · Gardner		G27	1871-1	Mouth gags · Roser-Koenig		C33	2015-0	Bone curettes · Williger		G21
1807-13MD	Gracey curettes · Mesial-Distal · Gracey	Asa60	G11	1832-2	Bone chisels and gouges · Gardner		G27	1871-2	Mouth gags · Roser-Koenig		C33	2015-00	Bone curettes · Williger		G21
1807-14	Gracey curettes · Gracey	Asa60	G11	1832-5	Bone chisels and gouges · Gardner		G27	1880	Mallets · Partsch		E16	2015-1	Bone curettes · Williger		G21
1807-14AF	Gracey curettes · AF · Gracey	Asa60	G12	1832-5R	Bone chisels and gouges · Gardner		G27	1881	Mallets · Mead		E16	2016-0	Bone curettes		G21
1807-14MF	Gracey curettes · MF · Gracey	Asa60	G13	1832-6	Bone chisels and gouges · Gardner		G27	1881-R	Inserts for mallets · Teflon		E16	2016-00	Bone curettes		G21
1807-16	Gracey curettes · Gracey	Asa60	G11	1833-1W	Bone chisels and gouges · Wakefield		G27				G29	2016-1	Bone curettes		G21
1807-16AF	Gracey curettes · AF · Gracey	Asa60	G12	1833-2W	Bone chisels and gouges · Wakefield		G27	1882	Mallets · Mead		G29	2100-CS	Cone-socket Mouth Mirrors - Handles	Octagonal	B20
1807-16MF	Gracey curettes · MF · Gracey	Asa60	G13					1884	Mallets · Vickers		G29	2101-CS	Cone-socket Mouth Mirrors - Handles	Asa60	B20
1807-18	Gracey curettes · Gracey	Asa60	G11	1834-3	Bone chisels and gouges · Buckley		G27	1885	Mallets · Herbert		G29	2102-CS	Cone-socket Mouth Mirrors - Handles	Exagonal	B20
1808-1	Curettes and Scalars · De Marco	Asa60	G5	1835-3	Bone chisels and gouges · Partsch		G28	1890-1F	Grinding stones · fine grain		G32	2104-B	Simple stem Mouth Mirrors - Handles	Alu80	B19
1808-2	Curettes and Scalars · De Marco	Asa60	G5	1835-4	Bone chisels and gouges · Partsch		G28	1890-1M	Grinding stones · medium grain		G32	2104-C	Simple stem Mouth Mirrors - Handles	Alu80	B19
1809-1	Curettes and Scalars · Goldman-Fox	Asa60	G6	1835-5	Bone chisels and gouges · Partsch		G28	1890-2	Grinding stones		G32	2104-G	Simple stem Mouth Mirrors - Handles	Alu80	B19
1809-2	Curettes and Scalars · Goldman-Fox	Asa60	G6	1835-6	Bone chisels and gouges · Partsch		G28	1890-3	Grinding stones		G32	2104-R	Simple stem Mouth Mirrors - Handles	Alu80	B19
1809-21	Curettes and Scalars · Goldman-Fox	Asa60	G6	1836-3	Bone chisels and gouges · Partsch		G28	1890-4	Grinding stones		G32	2104-V	Simple stem Mouth Mirrors - Handles	Alu80	B19
1809-3	Curettes and Scalars · Goldman-Fox	Asa60	G6	1836-4	Bone chisels and gouges · Partsch		G28	1890-5	Grinding stones		G32	2200E-4	Simple stem Mouth Mirrors		B18
1809-4	Curettes and Scalars · Goldman-Fox	Asa60	G6	1836-5	Bone chisels and gouges · Partsch		G28	1890-6	Grinding stones		G33	2200E-5	Simple stem Mouth Mirrors		B18
1809-5	Curettes and Scalars · Goldman-Fox	Asa60	G6	1836-6	Bone chisels and gouges · Partsch		G28	1890-7	Grinding stones		G33	2200E-6	Simple stem Mouth Mirrors		B18
1809-6	Curettes and Scalars · Goldman-Fox	Asa60	G6	1837-3	Bone chisels and gouges · Partsch		G28	1891-1	Grinding stones		G33	2201E-4	Simple stem Mouth Mirrors		B18
1810-07	Files · Hirschfeld	Asa60	G22	1837-4	Bone chisels and gouges · Partsch		G28	1900-1L	Scalers · left	Asa60	G15	2201E-5	Simple stem Mouth Mirrors		B18
1811-37	Chisels · back-action · Rhodes	Asa60	G26	1837-5	Bone chisels and gouges · Partsch		G28	1900-1R	Scalers · right	Asa60	G15	2210E-4	Cone-socket Mouth Mirrors		B20
1812-02S	Files · Sugarman	Asa60	G22	1837-6	Bone chisels and gouges · Partsch		G28	1900-2L	Scalers · left	Asa60	G15	2210E-5	Cone-socket Mouth Mirrors		B20
1812-04S	Files · Sugarman	Asa60	G22	1838-3	Bone chisels and gouges · Partsch		G28	1900-2R	Scalers · right	Asa60	G15	2211E-4	Cone-socket Mouth Mirrors - Handles		B20
1813-10	Files · Schluger	Asa60	G22	1838-4	Bone chisels and gouges · Partsch		G28	1900-M23	Scalers · universal scaler	Asa60	G14	2211E-5	Cone-socket Mouth Mirrors - Handles		B20
1815-11	Gingivectomy knives · Goldman-Fox	Asa60	G25	1838-5	Bone chisels and gouges · Partsch		G28	1901-1	Scalers	Asa60	G15	2220E-4	Simple stem Mouth Mirrors · Rhodium		B18
1815-7	Gingivectomy knives · Goldman-Fox	Asa60	G25	1838-6	Bone chisels and gouges · Partsch		G28	1902-1	Scalers · Towner Jacquette	Asa60	G14	2220E-5	Simple stem Mouth Mirrors · Rhodium		B18
1815-8	Gingivectomy knives · Goldman-Fox	Asa60	G25	1839-1	Freer single cut chisels · Freer		E16	1902-2	Scalers · Towner Jacquette	Asa60	G14	2221-4	Simple stem Mouth Mirrors · Titanium		B18
1815-9	Gingivectomy knives · Goldman-Fox	Asa60	G25	1839-2	Freer single cut chisels · Freer		E16	1903	Scalers · Towner	Asa60	G14	2221-5	Simple stem Mouth Mirrors · Titanium		B18
1816-04	Gingivectomy knives · Buck	Asa60	G25	1839-3	Freer single cut chisels · Freer		E16	1904-H5	Scalers	Asa60	G14	2230-5	Simple stem Mouth Mirrors		B18
1816-06	Gingivectomy knives · Buck	Asa60	G24	1840-1	Graduated chisels · straight		E17	1904-H6	Scalers	Asa60	G14	2231-5CS	Cone-socket Mouth Mirrors		B20
1817-02	Gingivectomy knives · Sanders	Asa60	G25	1840-2	Graduated chisels · curved		E17	1905-02	Scalers	Asa60	G14	2240-1	Simple stem Mouth Mirrors - Handles		B19
1817-05	Gingivectomy knives · Sanders	Asa60	G25	1840-3	Graduated chisels · straight		E17	1906-33	Scalers	Asa60	G15	2240-2	Simple stem Mouth Mirrors - Handles		B19
1818-20	Gingivectomy knives · USC Towner (University of South California)	Asa60	G25	1840-4	Graduated chisels · curved		E17	1909-H5	Scalers	Asa60	G15	2240-3	Simple stem Mouth Mirrors - Handles		B19
1819-CK3	Gingivectomy knives · Crane-Kaplan	Asa60	G25	1841-1	Trephine graduated burs		E34	1909-H6	Scalers	Asa60	G15	2240-4	Simple stem Mouth Mirrors - Handles		B19
1820-Z	Curettes and Scalars · Zerfing-Chisel	Asa60	G4	1841-2	Trephine graduated burs		E34	1909-H7	Scalers · Hygienist	Asa60	G15	2250-1	Photographic Mirrors · occlusal surfaces		B17
1821-02	Curettes and Scalars · Barnhart	Asa60	G5	1841-3	Trephine graduated burs		E34	2000-1	Bone curettes · Hemingway	Asa60	C45	2250-2	Photographic Mirrors · occlusal surfaces		B17
1821-06	Curettes and Scalars · Barnhart	Asa60	G5	1841-4	Trephine graduated burs		E34				E21	2250-3	Photographic Mirrors · buccal surfaces		B17
1822-ME1	Curettes and Scalars	Asa60	G5	1844-3	Mucotomes · straight		E26	2000-2	Bone curettes · Hemingway	Asa60	C45	2250-4	Photographic Mirrors · lingual surfaces		B17
1823-R04	Curettes and Scalars · Rule	Asa60	G5	1844-3C	Mucotomes · curved		E26				E21				
1824-14	Curettes and Scalars · anterior · Indiana University	Asa60	G5	1844-4	Mucotomes · straight		E26	2000-3	Bone curettes · Hemingway	Asa60	C45				
1824-18	Curettes and Scalars · posterior · Indiana University	Asa60	G5	1844-4C	Mucotomes · curved		E26				E21				
1825-12	Curettes and Scalars · Mc Call	Asa60	G7	1844-5	Mucotomes · straight		E26	2000-4	Bone curettes · Hemingway	Asa60	G20				
1825-12A	Curettes and Scalars · Mc Call	Asa60	G7	1844-5C	Mucotomes · curved		E26	2001-85	Bone curettes · Lucas	Asa60	G20				
1825-14	Curettes and Scalars · Mc Call	Asa60	G7	1844-6	Mucotomes · straight		E26	2001-86	Bone curettes · Lucas	Asa60	G20				
1825-14S	Curettes and Scalars · Mc Call	Asa60	G7	1844-6C	Mucotomes · curved		E26	2001-87	Bone curettes · Lucas	Asa60	G20				
1825-18S	Curettes and Scalars · Mc Call	Asa60	G7	1846	Bone mill		E27	2001-88	Bone curettes · Lucas	Asa60	G20				
1825-20	Curettes and Scalars · Mc Call	Asa60	G7	1849-1	Periosteals and Elevators · Partsch	Asa60	E24	2002-6	Mirrors (mouth) parallelometer		B19				
1826-T03	Curettes and Scalars · Taylor	Asa60	G8				G17	2003-1	Bone files · Polokoff		G23				
1827-204	Curettes and Scalars	Asa60	G8	1855-22	Periosteals and Elevators · retractor · Seldin		E25	2004-33	Bone files		G23				
1827-204S	Curettes and Scalars	Asa60	G8	1855-23	Periosteals and Elevators · retractor · Seldin		E25	2005-45	Bone files · Miller		G23				
1829-CK6	Curettes and Scalars · Crane-Kaplan	Asa60	G8	1856-1	Periosteals and Elevators · Williger		E25	2005-64	Bone files · Miller		E21				
1829-CK6S	Curettes and Scalars · Mini Crane-Kaplan	Asa60	G8				G19				G23				
1830-YG08	Curettes and Scalars · Younger-Good	Asa60	G8	1856-2	Periosteals and Elevators · Williger		E25	2006-10	Bone files		E21				
							G19	2007-12A	Bone files		G23				
				1857-1	Periosteals and Elevators · Williger		E25	2007-12CA	Bone files		G23				
				1857-2	Periosteals and Elevators · Williger		E25	2008-12	Bone files		G23				
							G19	2013-2	Bone curettes · U.S.A. model		G21				

code	description	handle	page	code	description	handle	page	code	description	handle	page	code	description	handle	page
2250-5	Photographic Mirrors · lingual surfaces		B17	2617-2	Retractors · left, sharp · Williger		C35	2730-2	Stainless steel instrument trays · insert frame for 23 instruments		I5	2771-2R	Stainless steel instrument cassettes · medium - for 5 instruments - Red		I2
2300-D	Crown removers		F40	2617-3	Retractors · right, sharp · Williger		C35	2730-3	Rubber dam instrument kit · insert frame		F10	2771-2V	Stainless steel instrument cassettes · medium - for 5 instruments - Green		I2
2300-S	Crown removers		F40	2617-33	Retractors · right, sharp · Williger		C35	2730-4	Stainless steel instrument trays · insert frame for 8 instruments		I7	2771-G	Holders (instruments) · for 5 places - Blue - silicone		I3
2301	Tips for crown removers		F40	2618-1	Retractors · straight, blunt · Williger		C35	2730-5	Stainless steel instrument trays · insert frame for 4 instruments		I7	2771-GA	Holders (instruments) · for 5 places - Orange - silicone		I3
2302	Tips for crown removers		F40	2618-2	Retractors · left, blunt · Williger		C35	2731-1	Rubber dam instrument kit		F11	2771-GR	Holders (instruments) · for 5 places - Red - silicone		I3
2305-D	Crown removers		F40	2620-1	Retractors · Middeldorpf		C37	2737-1	Stainless steel trays		I12	2771-GV	Holders (instruments) · for 5 places - Green - silicone		I3
2306	Tips for crown removers		F40	2620-2	Retractors · Middeldorpf		E12	2737-2	Stainless steel trays		I12	2772-1	Stainless steel instrument cassettes · mini - for 5 instruments - Blue		I3
2307	Tips for crown removers		F40	2620-3	Retractors · Middeldorpf		C37	2737-3	Stainless steel trays		I12	2772-1A	Stainless steel instrument cassettes · mini - for 5 instruments - Orange		I3
2308	Tips for crown removers		F40	2620-3	Retractors · Middeldorpf		C37	2737-4	Stainless steel trays		I12	2772-1R	Stainless steel instrument cassettes · mini - for 5 instruments - Red		I3
2320	Crown spreaders		F40	2621-1	Retractors · Langenbeck		C36	2750-1	Drinking cup dispensers		A20	2772-1V	Stainless steel instrument cassettes · mini - for 5 instruments - Green		I3
2331-1	Copper rings removing pliers · straight · Furrer		F43	2621-2	Retractors · Langenbeck		C36	2750-2	Drinking cup dispensers		A20	2772-G	Frame · for 10 places - Blue - silicone		I3
2331-2	Copper rings removing pliers · curved · Furrer		F43	2621-3	Retractors · Langenbeck		C36	2751-1	Dispensers (cotton pellet) stainless steel		I19	2772-GA	Frame · for 10 places - Orange - silicone		I3
2340-0	Crown spreaders		F41	2621-4	Retractors · Langenbeck		C36	2770-1	Stainless steel instrument cassettes · large - for 20 instruments - Blue		I2	2772-GR	Frame · for 10 places - Red - silicone		I3
2340-1	Crown spreaders		F41	2621-5	Retractors · Langenbeck		C36	2770-1A	Stainless steel instrument cassettes · large - for 20 instruments - Orange		I2	2772-GV	Frame · for 10 places - Green - silicone		I3
2340-2	Crown spreaders		F41	2622-1	Retractors · Langenbeck		C36	2770-1R	Stainless steel instrument cassettes · large - for 20 instruments - Red		I2	2773-G	Frame · for 5 places - Blue - silicone		I3
2340-3	Crown spreaders		F41	2622-2	Retractors · Langenbeck		C36	2770-1V	Stainless steel instrument cassettes · large - for 20 instruments - Green		I2	2773-GA	Frame · for 5 places - Orange - silicone		I3
2400	Direct bond bracket holders		H34	2622-3	Retractors · Langenbeck		C36	2770-2	Stainless steel instrument cassettes · large - for 15 instruments - Blue		I2	2773-GR	Frame · for 5 places - Red - silicone		I3
2401	Direct bond bracket holders		H34	2622-4	Retractors · Langenbeck		C36	2770-2A	Stainless steel instrument cassettes · large - for 15 instruments - Orange		I2	2773-GV	Frame · for 5 places - Green - silicone		I3
2402	Direct bond bracket holders		H34	2622-5	Retractors · Langenbeck		C36	2770-2R	Stainless steel instrument cassettes · large - for 15 instruments - Red		I2	2774	Spare part (cassettes) · knob complete of washers		I3
2410	Band pusher · Mershon		H34	2623-1	Retractors · Kocher		C36	2770-2V	Stainless steel instrument cassettes · large - for 15 instruments - Green		I2	2775	Clips for locking trays for scissors		I3
2411	Band setter · band setter		H34	2623-2	Retractors · Kocher		C36	2770-3	Stainless steel instrument cassettes · large - for 10 instruments - Blue		I2	2780-1A	Stainless steel instrument cassettes · implant - h. 60 mm		I2
2412	Band pusher · used in all heat sterilizers		H34	2624-1	Retractors · Kocher		C36	2770-3A	Stainless steel instrument cassettes · large - for 10 instruments - Orange		I2	2800-L1	Perforated aluminum impression trays		J36
2450	Separating pliers · for elastics and separators		H35	2624-2	Retractors · Kocher		C36	2770-3R	Stainless steel instrument cassettes · large - for 10 instruments - Red		I2	2800-L2	Perforated aluminum impression trays		J36
2500-1	Crown pliers · Böhm		F43	2625-1	Ramus retractors for nasal spine		C36	2770-3V	Stainless steel instrument cassettes · large - for 10 instruments - Green		I2	2800-L2D	Perforated aluminum impression trays		J36
2500-2	Crown pliers · Böhm		F43	2626-1	Ramus retractors for nasal spine		C36	2770-G	Holders (instruments) · for 10 places - Blue - silicone		I3	2800-L2S	Perforated aluminum impression trays		J36
2550-1	Calipers · for wax · Iwanson		F42	2627	Retractors		C37	2770-GA	Holders (instruments) · for 10 places - Orange - silicone		I3	2800-L3	Perforated aluminum impression trays		J36
2550-2	Calipers · for metal · Iwanson		F42	2628-1	Labial retractors		C37	2770-GR	Holders (instruments) · for 10 places - Red - silicone		I3	2800-L4	Perforated aluminum impression trays		J36
2555	Calipers · Boley		F42	2628-2	Vestibular retractor		E10	2770-GV	Holders (instruments) · for 10 places - Green - silicone		I3	2800-L4D	Perforated aluminum impression trays		J36
2556-1	Calipers · aluminum, graded in millimeters and inches		K30	2650-02	Antrum probes · Bowman		C37	2771-1	Stainless steel instrument cassettes · medium - for 10 instruments - Blue		I2	2800-L4S	Perforated aluminum impression trays		J36
2556-2	Calipers · aluminum, graded in millimeters and inches · Townley		K30	2650-08	Antrum probes · Bowman		C37	2771-1A	Stainless steel instrument cassettes · medium - for 10 instruments - Orange		I2	2800-L5	Perforated aluminum impression trays		J36
2556-3	Calipers · Jameson		K30	2651-1	Antrum probes		C37	2771-1R	Stainless steel instrument cassettes · medium - for 10 instruments - Red		I2	2800-L6	Perforated aluminum impression trays		J36
2556-4	Calipers		E33	2651-2	Antrum probes		C37	2771-1V	Stainless steel instrument cassettes · medium - for 10 instruments - Green		I2	2800-L6D	Perforated aluminum impression trays		J36
2557-1	Calipers		K30	2700-G	Stainless steel instrument trays · insert frame for 7 instruments		I6	2771-2	Stainless steel instrument cassettes · medium - for 5 instruments - Blue		I2	2800-L6S	Perforated aluminum impression trays		J36
2601	Lip retractors · Columbia		C34	2700-L	Stainless steel instrument trays · non-perforated base		I6	2771-2A	Stainless steel instrument cassettes · medium - for 5 instruments - Orange		I2				
2602-1	Lip retractors · Sternberg		C34	2700-U	Stainless steel instrument trays · non-perforated lid		I6								
2602-2	Lip retractors · Sternberg		C34	2702-L	Stainless steel instrument trays · perforated base		I6								
2602-3	Lip retractors · Sternberg		C34	2702-U	Stainless steel instrument trays · perforated lid		I6								
2604	Tongue depressors · cheek retractor · University of Minnesota		C34	2720-L	Stainless steel instrument trays · non-perforated base		I5								
2605	Tongue depressors		C34	2720-U	Stainless steel instrument trays · non-perforated lid		I4								
2606	Tongue depressors		C34	2721-L	Stainless steel instrument trays · perforated base		I4								
2607	Tongue depressors · Buchwald		C34	2721-U	Stainless steel instrument trays · perforated lid		I4								
2608	Tongue depressors · Brünings		C34	2723-L	Stainless steel instrument trays · non-perforated base		I7								
2609-2	Lip retractors · Orringer medium		C34	2723-U	Stainless steel instrument trays · non-perforated lid		I7								
2611-1	Retractors · blunt		C35	2724-L	Stainless steel instrument trays · non-perforated base		I7								
2611-2	Retractors · blunt		C35	2724-U	Stainless steel instrument trays · non-perforated lid		I7								
2613-1	Retractors · sharp · Senn-Miller		C35	2730-1	Stainless steel instrument trays · insert frame for 16 instruments		I5								
2613-2	Retractors · blunt · Senn-Miller		C35												
2615-1	Retractors · Kilner		C35												
2616-1	Retractors · Farabeuf		C35												
2617-1	Retractors · straight, sharp · Williger		C35												





code	description	handle	page	code	description	handle	page	code	description	handle	page	code	description	handle	page
2816-U3	Perforated aluminum impression trays - ORTHOBABY for children		J39	2900E-TTS15	Multi-color saliva ejectors		A5	3030	Clamp forceps · Ivory lightweight		F9	3052-W7	Rubber dam clamps · wingless clamp		F6
2819-OCG	Partial occlusal stainless steel impression trays		J40	2900E-VT13	Multi-color saliva ejectors		A4	3031	Clamp forceps · Brewer		F9	3052-W8	Rubber dam clamps · wingless clamp		F7
2819-OCP	Partial occlusal stainless steel impression trays		J40	2900E-VT15	Multi-color saliva ejectors		A4	3032	Punching forceps · Ainsworth		F8	3052-W8A	Rubber dam clamps · wingless clamp		F6
2850-8	Orthodontic polycarbonate impression trays - ORTHOBABY for children		J42	2900E-VTS15	Multi-color saliva ejectors		A5	3033	Punching forceps · Ivory		F8	3070-5	Matrix retainers · Ivory		F46
2851-7	Polycarbonate impression trays - edentulous		J43	2900E-ZT13	Multi-color saliva ejectors		A5	3034	Clamp forceps · Stoke		F9	3070-6	Matrix retainers · Ivory		F46
2851-13	Polycarbonate impression trays - edentulous		J43	2900E-ZT15	Multi-color saliva ejectors		A5	3040-1	Rubber dam instruments		F9	3070-7	Matrix retainers · Ivory		F46
2852-12	Polycarbonate impression trays		J42	2901E-AT13	Multi-color saliva ejectors		A4	3041-1	Rubber dam instruments		F9	3071	Matrix retainers · Ivory		F46
2853E-1	Disposable plastic impression trays		A23	2901E-AT15	Multi-color saliva ejectors		A4	3045	Rubber dam instruments · latex dam vacuum packed 36 pcs/pack		F8	3072	Matrix retainers · Didner		F46
2853E-1DS	Disposable plastic impression trays		A23	2901E-TT13	Multi-color saliva ejectors		A4	3050-60	Rubber dam clamps · wingless clamp		F5	3073-1	Matrix retainers · Tofflemire universal		F46
2853E-2	Disposable plastic impression trays		A23	2901E-TT15	Multi-color saliva ejectors		A4	3051-202	Rubber dam clamps · winged clamp		F7	3073-2	Matrix retainers · Tofflemire Junior		F46
2853E-2DS	Disposable plastic impression trays		A23	2901E-VT13	Multi-color saliva ejectors		A4	3051-205	Rubber dam clamps · wingless clamp		F7	3073-3	Matrix retainers · Tofflemire Senior		F46
2853E-3	Disposable plastic impression trays		A23	2901E-VT15	Multi-color saliva ejectors		A4	3051-210	Rubber dam clamps · winged clamp		F4	3081	Matrix · Tofflemire		F47
2853E-4	Disposable plastic impression trays		A23	2902-L	Surgical stainless steel saliva ejectors		C44	3051-212	Rubber dam clamps · winged clamp		F4	3081-1	Matrix · Tofflemire		F47
2880-FR	Perforated aluminum impression trays for implantology · bur in tungsten carbide		J38	2902-M	Surgical stainless steel saliva ejectors		C44	3051-26	Rubber dam clamps · wingless clamp		F6	3081-2	Matrix · Tofflemire		F47
2880-L1	Perforated aluminum impression trays for implantology		J38	2902-S	Surgical stainless steel saliva ejectors		C44	3051-29	Rubber dam clamps · winged clamp		F5	3081-3	Matrix · Tofflemire		F47
2880-L2	Perforated aluminum impression trays for implantology		J38	2903E-BA155	Soft-tip saliva ejectors - Total-Comfort		A3	3051-51	Rubber dam clamps · wingless clamp		F6	3082-5	Bands for matrix retainers		F47
2880-L3	Perforated aluminum impression trays for implantology		J38	2903E-BAS155	Soft-tip saliva ejectors - Total-Comfort		A3	3052-0	Rubber dam clamps · winged clamp		F4	3082-6	Bands for matrix retainers		F47
2880-L4	Perforated aluminum impression trays for implantology		J38	2903E-BT155	Soft-tip saliva ejectors - Total-Comfort		A3	3052-00	Rubber dam clamps · winged clamp		F4	3082-7	Bands for matrix retainers		F47
2880-L5	Perforated aluminum impression trays for implantology		J38	2903E-BTS155	Soft-tip saliva ejectors - Total-Comfort		A3	3052-1	Rubber dam clamps · winged clamp		F5	3101	Accessories · alcohol burner		I19
2880-L6	Perforated aluminum impression trays for implantology		J38	2903E-TA155	Soft-tip saliva ejectors - Total-Comfort		A3	3052-12A	Rubber dam clamps · winged, serrated clamp		F7	3101-1	Accessories · spare wick		I19
2880-U1	Perforated aluminum impression trays for implantology		J38	2903E-TAS155	Soft-tip saliva ejectors - Total-Comfort		A3	3052-13A	Rubber dam clamps · winged, serrated clamp		F7	3200	Napkins - AsaRainbow · patient bib chain		A7
2880-U2	Perforated aluminum impression trays for implantology		J38	2903E-TT155	Soft-tip saliva ejectors - Total-Comfort		A3	3052-14	Rubber dam clamps · winged clamp		F6	3251E-B/9	Bibs		A19
2880-U3	Perforated aluminum impression trays for implantology		J38	2903E-TTS155	Soft-tip saliva ejectors - Total-Comfort		A3	3052-14A	Rubber dam clamps · winged clamp		F7	3251E-C/9	Bibs		A19
2880-U4	Perforated aluminum impression trays for implantology		J38	2904-10	Surgical stainless steel saliva ejectors · Frazier		C44	3052-14T	Rubber dam clamps · winged, serrated clamp		F6	3251E-D/9	Bibs		A19
2880-U5	Perforated aluminum impression trays for implantology		J38	2904-12	Surgical stainless steel saliva ejectors · Frazier		C44	3052-1T	Rubber dam clamps · winged, serrated clamp		F5	3251E-G/9	Bibs		A19
2880-U6	Perforated aluminum impression trays for implantology		J38	2904-6	Surgical stainless steel saliva ejectors · Frazier		C44	3052-2	Rubber dam clamps · winged clamp		F5	3251E-L/9	Bibs		A19
2900E-AT13	Multi-color saliva ejectors		A4	2904-8	Surgical stainless steel saliva ejectors · Frazier		C44	3052-2A	Rubber dam clamps · winged clamp		F5	3251E-LI/9	Bibs		A19
2900E-AT15	Multi-color saliva ejectors		A4	2905-155	Surgical aspirator tips		C44	3052-2AT	Rubber dam clamps · winged, serrated clamp		F5	3251E-O/9	Bibs		A19
2900E-ATS15	Multi-color saliva ejectors		A5	2905-AD	Surgical aspirator tips		C44	3052-2T	Rubber dam clamps · winged, serrated clamp		F5	3251E-O/9	Bibs		A19
2900E-BBS15	Multi-color saliva ejectors		A5	2908E-AT13	Mint-scented saliva ejectors - AsaFresh		A2	3052-3	Rubber dam clamps · winged clamp		F5	3251E-V/9	Bibs		A19
2900E-BT13	Multi-color saliva ejectors		A4	2908E-AT15	Mint-scented saliva ejectors - AsaFresh		A2	3052-4	Rubber dam clamps · winged clamp		F6	3252E-B/9	Bibs		A19
2900E-BT15	Multi-color saliva ejectors		A4	2908E-BBS15	Mint-scented saliva ejectors - AsaFresh		A2	3052-7	Rubber dam clamps · winged clamp		F6	3252E-C/9	Bibs		A19
2900E-GT13	Multi-color saliva ejectors		A4	2908E-TCS15	Mint-scented saliva ejectors - AsaFresh		A2	3052-8	Rubber dam clamps · winged clamp		F7	3252E-D/9	Bibs		A19
2900E-GT15	Multi-color saliva ejectors		A4	2908E-TT13	Mint-scented saliva ejectors - AsaFresh		A2	3052-8A	Rubber dam clamps · winged clamp		F6	3252E-G/9	Bibs		A19
2900E-LT13	Multi-color saliva ejectors		A4	2908E-TT15	Mint-scented saliva ejectors - AsaFresh		A2	3052-9	Rubber dam clamps · winged clamp		F4	3252E-L/9	Bibs		A19
2900E-LT15	Multi-color saliva ejectors		A4	2908E-TTS15	Mint-scented saliva ejectors - AsaFresh		A2	3052-9T	Rubber dam clamps · winged clamp		F4	3252E-LI/9	Bibs		A19
2900E-OT13	Multi-color saliva ejectors		A5	2908E-VT13	Mint-scented saliva ejectors - AsaFresh		A2	3052-W0	Rubber dam clamps · wingless clamp		F5	3252E-O/9	Bibs		A19
2900E-OT15	Multi-color saliva ejectors		A5	2908E-VT15	Mint-scented saliva ejectors - AsaFresh		A2	3052-W1	Rubber dam clamps · wingless clamp		F5	3252E-V/9	Bibs		A19
2900E-RT13	Multi-color saliva ejectors		A5	2908E-VTS15	Mint-scented saliva ejectors - AsaFresh		A2	3052-W14	Rubber dam clamps · wingless clamp		F6	3301E-L	Examination gloves		A15
2900E-RT15	Multi-color saliva ejectors		A5					3052-W14A	Rubber dam clamps · wingless clamp		F7	3301E-M	Examination gloves		A15
2900E-TCS15	Multi-color saliva ejectors		A5					3052-W2	Rubber dam clamps · wingless clamp		F5	3301E-S	Examination gloves		A15
2900E-TT13	Multi-color saliva ejectors		A4					3052-W2A	Rubber dam clamps · wingless clamp		F5	3301E-XS	Examination gloves		A15
2900E-TT15	Multi-color saliva ejectors		A4					3052-W3	Rubber dam clamps · wingless clamp		F6	3303E-L	Examination gloves		A15
								3052-W4	Rubber dam clamps · wingless clamp		F7	3303E-M	Examination gloves		A15
												3303E-S	Examination gloves		A15
												3305-L	Examination gloves		A15
												3305-M	Examination gloves		A15
												3305-S	Examination gloves		A15
												3305-XS	Examination gloves		A15
												3309E-L	Examination gloves		A16
												3309E-M	Examination gloves		A16
												3309E-S	Examination gloves		A16
												3309E-XS	Examination gloves		A16
												3310E-L	Examination gloves		A16
												3310E-M	Examination gloves		A16
												3310E-S	Examination gloves		A16
												3310E-XS	Examination gloves		A16

code	description	handle	page	code	description	handle	page	code	description	handle	page	code	description	handle	page	
3311E-L	Examination gloves		A16	3520-1	Cotton rolls		A12	5011-19	Articulators - spare parts - hinge rod spring		K9	5053-1	Articulators - spare parts - magnetic rod		K9	
3311E-M	Examination gloves		A16	3520-2	Cotton rolls		A12	5011-20	Articulators - spare parts - back rod support		K9	5053-2	Articulators - spare parts - rod ferrule		K9	
3311E-S	Examination gloves		A16	3520-3	Cotton rolls		A12	5011-21	Articulators - spare parts - back rod		K9	5053-3	Articulators - spare parts - table for magnetic rod		K9	
3312E-L	Examination gloves		A16	3600E	Synthetic instant ice		A22	5011-22	Articulators - spare parts - adjusting screw		K9	5054	Articulators - spare parts - occlusal table assembly (5050-4 + 5051 + 5050-2)		K9	
3312E-M	Examination gloves		A16	3700-B	Dappen dishes		A9	5011-23	Articulators - spare parts - adjusting screw locknut		K9	5100	Amalgam/wax carvers · Hylin		K14	
3312E-S	Examination gloves		A16	3700-C	Dappen dishes		A9	5020	Easy Bow · complete set		K10	5100-1	Amalgam/wax carvers · graded handle in mm · Hylin		K14	
3312E-XS	Examination gloves		A16	3700-G	Dappen dishes		A9	5021	Easy Bow · face bow		K10	5101	Amalgam/wax carvers · Hylin-Le Cron		K14	
3313E-L	Examination gloves		A17	3700-MX	Dappen dishes		A8	5022	Easy Bow · fork holder		K10	5102	Amalgam/wax carvers · Hylin		K14	
3313E-M	Examination gloves		A17	3700-N	Dappen dishes		A9	5023-1	Easy Bow · fork		K10	5103	Amalgam/wax carvers · Hylin		K14	
3313E-S	Examination gloves		A17	3700-R	Dappen dishes		A9	5023-2	Easy Bow · fork		K10	5104	Amalgam/wax carvers		K14	
3313E-XS	Examination gloves		A17	3710	Plastic syringes		A20	5023-3	Easy Bow · fork		K10	5105	Amalgam/wax carvers · Le Cron		K15	
3314E-L	Examination gloves		A17	3818-B	Cups		A20	5024	Easy Bow · transfer table		K10	5106	Amalgam/wax carvers · Le Cron		K15	
3314E-M	Examination gloves		A17	5000-1	Articulators - spare parts - mounting plate		K6	5030	Articulators - average values		K4	5107	Amalgam/wax carvers · Le Cron		K15	
3314E-S	Examination gloves		A17	5000-1M	Articulators - spare parts - magnetic mounting plate - complete		K9	5030-2	Articulators - spare parts - occlusal table		K9	5108	Amalgam/wax carvers · Le Cron		K15	
3314E-XS	Examination gloves		A17	5000-2	Articulators - spare parts - occlusal table		K9	5030-3	Articulators - spare parts - incisal guide rod		K9	5109	Amalgam/wax carvers · Zahle		K15	
3315E-L	Examination gloves		A17	5000-3	Articulators - spare parts - incisal guide rod		K9	5030-6	Articulators - spare parts - locking knob for spacer		K9	5110	Amalgam/wax carvers · Zahle		K15	
3315E-M	Examination gloves		A17	5000-4	Articulators - spare parts - incisal guide table (10°)		K9	5030-9	Articulators - spare parts - condylar guidance		K9	5111	Amalgam/wax carvers · Zahle		K16	
3315E-S	Examination gloves		A17	5000-4N	Articulators - spare parts - incisal guide table (10°)		K9	5030-10	Articulators - spare parts - bearing rod		K9	5112-1	Amalgam/wax carvers · P.K. Thomas	Asa60	K17	
3315E-XS	Examination gloves		A17	5000-5	Articulators - spare parts - metallic locking knob		K9	5030-29	Articulators - spare parts - spacer		K7	5112-1AL	Amalgam/wax carvers · P.K. Thomas	Alu80	K17	
3316E-L	Examination gloves		A17	5000-6	Articulators - spare parts - locking knob		K9	5032	Articulators - average values		K5	5112-2	Amalgam/wax carvers · P.K. Thomas	Asa60	K17	
3316E-M	Examination gloves		A17	5000-7	Articulators - spare parts - adjusting screw - side shift		K9	5032-16	Articulators - spare parts - inclined contrast table		K9	5112-2AL	Amalgam/wax carvers · P.K. Thomas	Alu80	K17	
3316E-S	Examination gloves		A17	5000-8	Articulators - spare parts - incisal pin		K9	5032-17	Articulators - spare parts - hinge rod		K9	5112-3	Amalgam/wax carvers · Asa Com 1/1B · P.K. Thomas	Asa60	F48	
3316E-XS	Examination gloves		A17	5000-12	Articulators - spare parts - side shift spring		K9	5032-21	Articulators - spare parts - back rod		K9	5112-3AL	Amalgam/wax carvers · P.K. Thomas	Alu80	K17	
3400-300	Sterilization rolls		A13	5000-13	Articulators - spare parts - side shift cylinder		K9	5032-22	Articulators - spare parts - adjusting screw		K9	5112-4	Amalgam/wax carvers · Asa Com 13/13B · P.K. Thomas	Asa60	F50	
3403-140	Sterilization pouches		A18	5000-18	Articulators - spare parts - M5 screw - incisal table		K9	5033	Articulators - spare parts - fast caliper		K9	5112-4AL	Amalgam/wax carvers · P.K. Thomas	Alu80	K17	
3403-75	Sterilization pouches		A18	5000-24	Articulators - spare parts - rubber nubs		K7	5050	Articulators - average values		K2	5112-5	Amalgam/wax carvers · P.K. Thomas	Asa60	K17	
3403-90	Sterilization pouches		A18	5000-25	Articulators - spare parts - cast fastening washers		K7	5050Plus	Articulators - average values		K3	5112-5AL	Amalgam/wax carvers · P.K. Thomas	Alu80	K17	
3400E-55	Sterilization rolls		A13	5000-26	Articulators - spare parts - magnet		K7	5050-2	Articulators - spare parts - support for occlusal table and template		K9	5113	Amalgam/wax carvers · Gritman		K16	
3400E-75	Sterilization rolls		A13	5000-30	Articulators - spare parts - magnet holder		K9	5050-3	Articulators - spare parts - incisal guide rod		K9	5114	Amalgam/wax carvers · Beale		K16	
3400E-100	Sterilization rolls		A13	5001	Articulators - occlusor		K6	5050-4	Articulators - spare parts - knurled knob for template and occlusal table		K9	5114-1	Periosteals and Elevators · Beale	Octagonal	E22	
3400E-150	Sterilization rolls		A13	5002	Articulators - average values		K6	5050-6	Articulators - spare parts - locking knob		K9	5115	Amalgam/wax carvers · Roach		K16	
3400E-200	Sterilization rolls		A13	5010-10	Articulators - spare parts - bearing rod		K9	5050-8	Articulators - spare parts - locking pin		K9	5116	Amalgam/wax carvers · Vehe		K16	
3400E-250	Sterilization rolls		A13	5011-4	Articulators - spare parts - incisal guide table (0°)		K9	5050-17	Articulators - spare parts - hinge rod		K9	5150	Ceramic sculpturing instruments		K21	
3450E-B	Surgical face masks		A14	5011-6	Articulators - spare parts - locking knob		K9	5050-20	Articulators - spare parts - back rod support		K9	5150-1	Ceramic sculpturing instruments	Alu80	K21	
3450E-C	Surgical face masks		A14	5011-9	Articulators - spare parts - condylar guidance		K9	5050-21	Articulators - spare parts - back rod		K9	5150-2	Ceramic sculpturing instruments	Alu80	K21	
3450E-HC	Surgical face masks		A14	5011-11	Articulators - spare parts - rubber cap		K9	5050-24	Articulators - spare parts - rubber nubs		K9	5151	Ceramic sculpturing instruments		K21	
3450E-HR	Surgical face masks		A14	5011-16	Articulators - spare parts - inclined contrast table		K9	5051	Articulators - spare parts - occlusal table		K9	5151-1	Ceramic sculpturing instruments · Greenstein	Alu80	K21	
3450E-R	Surgical face masks		A14	5011-17	Articulators - spare parts - hinge rod		K9	5052	Articulators - spare parts - template		K9	5151-2	Ceramic sculpturing instruments · Greenstein	Alu80	K21	
3450E-V	Surgical face masks		A14	5011-18	Articulators - spare parts - hinge rod washer		K9	5053	Articulators - spare parts - magnetic rod kit		K9	5151-3	Ceramic sculpturing instruments · Greenstein	Alu80	K21	
3510-B	Napkins - AsaRainbow		A6									5153-1	Composite instruments · Asa Com 7/7B	Asa60	F49	
3510-BX	Napkins - AsaRainbow		A6									5155-1	Ceramic sculpturing instruments		K21	
3510-C	Napkins - AsaRainbow		A6													
3510-D	Napkins - AsaRainbow		A6													
3510-G	Napkins - AsaRainbow		A6													
3510-L	Napkins - AsaRainbow		A6													
3510-LI	Napkins - AsaRainbow		A6													
3510-LI	Napkins - AsaRainbow		A6													
3510-O	Napkins - AsaRainbow		A6													
3510-P	Napkins - AsaRainbow		A6													
3510-PE	Napkins - AsaRainbow		A6													
3510-V	Napkins - AsaRainbow		A6													
3511-B	Napkins - AsaRainbow		A6													
3511-BX	Napkins - AsaRainbow		A6													
3511-C	Napkins - AsaRainbow		A6													
3511-D	Napkins - AsaRainbow		A6													
3511-G	Napkins - AsaRainbow		A6													
3511-L	Napkins - AsaRainbow		A7													
3511-LI	Napkins - AsaRainbow		A7													
3511-LI	Napkins - AsaRainbow		A7													
3511-O	Napkins - AsaRainbow		A7													
3511-P	Napkins - AsaRainbow		A7													
3511-PE	Napkins - AsaRainbow		A7													
3511-V	Napkins - AsaRainbow		A7													

code	description	handle	page	code	description	handle	page	code	description	handle	page	code	description	handle	page
5155-2	Ceramic sculpturing instruments		K21	5600-2	Crown scissors · curved, one blade serrated		F45 K28	5868	Wire forming pliers · long rounded jaws pliers		H19	8001	Instruments protective lubricant · Steril Oil		G33
5155-3	Ceramic sculpturing instruments		K21	5601-1	Crown scissors · straight		F45 K28	5869-1	Wire forming pliers · mini · Aderer		H21	8002	Instruments protective lubricant · Steril Oil		D71 I12
5156-1	Ceramic sculpturing instruments		K21	5601-2	Crown scissors · curved		F45 K28	5869-2	Wire forming pliers · standard · Aderer		H21	8010	Instruments protective lubricant · Silicone		D71 I12
5156-2	Ceramic sculpturing instruments		K21	5700	Wire scissors · straight, one blade serrated · universal		F45 K28	5870	Wire forming pliers · loop universal pliers · Tweed		H14	8020	AsaClean · PH neutral solution to facilitate removal of alginate		J40
5156-3	Ceramic sculpturing instruments		K21	5700TC	Wire scissors · TC universal		F45	5871	Wire forming pliers · lighth bird beak pliers		H24	8801-1	Wire forming pliers · universal pliers · Delphin		H10
5160-1	Ceramic sculpturing instruments (tips)		K18	5800	Wire forming pliers · Nance		H12	5872-1	Wire forming pliers · Tweed (Angle)		H15	8801-2	Wire forming pliers · universal pliers		H10
5160-2	Ceramic sculpturing instruments (tips)		K18	5801-1	Wire forming pliers · Delphin universal		H10	5874-1	Wire forming pliers · universal pliers · How		H23	8802	Wire forming pliers · Waldsachs		H11
5160-3	Ceramic sculpturing instruments (tips)		K18	5801-3	Wire forming pliers · universal		H10	5874-2	Wire forming pliers · curved · How		H23	8803	Wire forming pliers · optical pliers		H26
5200-1	Wax knives · Fahnenstock		K22	5802	Wire forming pliers · Waldsachs		H11	5875-1	Wire forming pliers · flat bending pliers		H24	8804-1	Wire forming pliers · loop universal pliers · Tweed		H14
5200-2	Wax knives · Fahnenstock		K22	5806	Wire forming pliers · round-concave		H12	5875-2	Wire forming pliers · flat knurled bending pliers		H24	8804-2	Wire forming pliers · omega loop pliers · Tweed		H13
5201-1	Wax knives · Lessmann		K22	5809-1	Wire forming pliers · loop pliers · Tweed		H12	5876-1	Wire forming pliers · knurled bending pliers		H24	8804-2P	Wire forming pliers		H13
5201-2	Wax knives · Lessmann		K22	5809-2	Wire forming pliers · omega loop pliers · Tweed		H13	5876-2	Wire forming pliers · bending pliers		H24	8804-3P	Wire forming pliers		H13
5202-1	Wax knives		K22	5809-3	Wire forming pliers · loop pliers · Tweed		H15	5880-1	Cutters · wire cutter <= 0.9 mm		H8	8805	Wire forming pliers · Reynolds		H16
5202-2	Wax knives		K22	5812	Wire forming pliers · Reynolds		H16	5880-2	Cutters · wire cutter <= 1.5 mm		H8	8806	Wire forming pliers · hollow chop pliers		H26
5300-1	Plaster knives		K23	5818	Wire forming pliers · lingual arch pliers		H16	5880-3TC	Cutters · wire cutter <= 1.2 mm		H9	8807-1	Wire forming pliers · mini arch bending pliers		H17
5300-2	Plaster knives · Gritman		K23	5819	Utility pliers · Weingart		H29	5900	Plaster cutting pliers · Asa Special Inox		K31	8807-2	Wire forming pliers · arch bending pliers		H17
5300-3	Plaster knives		K23	5821-1	Wire forming pliers · grooved pliers · De La Rosa		H18	6000	Mallets		K31	8807-3	Wire forming pliers · lingual arch pliers		H16
5300-4	Plaster knives		K23	5821-2	Wire forming pliers · non-grooved pliers · De La Rosa		H18	6001	Mallets		K31	8808-1	Utility pliers · Weingart		H29
5400-1	Rigid spatulas for plaster, alginate and elastomers		K24	5822-1	Wire forming pliers · wide bracket removing pliers		H31	6002	Mallets		K31	8808-2	Utility pliers · slim · Weingart		H29
5400-2	Rigid spatulas for plaster, alginate and elastomers		K24	5824-1	Utility pliers · wide bracket removing pliers		H32	6200	Fret saw		K33	8809	Utility pliers · wide bracket removing pliers		H31
5400-3	Rigid spatulas for plaster, alginate and elastomers		K24	5825	Utility pliers · angled bracket removing pliers		H30	6201-1	Fret saw blades · for plaster		K33	8810	Utility pliers · angled bracket removing pliers		H32
5400-4	Flexible spatulas for plaster, alginate and elastomers		K25	5826-1	Utility pliers · wide beak removing pliers		H30	6201-2	Fret saw blades · for metal		K33	8811-1	Utility pliers · short posterior band remover		H30
5400-5	Flexible spatulas for plaster, alginate and elastomers		K25	5826-2	Utility pliers · narrow beak removing pliers		H30	6300	Saw for models		K33	8811-1P	Utility pliers		H30 H31
5400-6	Flexible spatulas for plaster, alginate and elastomers		K25	5826-CR1	Utility pliers		H30	6301-1	Fret saw blades · for models		K33	8811-2	Utility pliers · long posterior band remover		H31
5400-7	Flexible spatulas for plaster, alginate and elastomers		K25	5826-CR2	Utility pliers		H30	6301-2	Fret saw blades · for models		K33	8812-1TC	Cutters · multi-use wire cutter		H7
5400-8	Rigid spatulas for plaster, alginate and elastomers		K24	5828-1	Utility pliers · short posterior band remover		H30	6301-3	Fret saw blades · for models		K33	8812-2TC	Cutters · hard wire cutter 15°		H4
5400-9	Rigid spatulas for plaster, alginate and elastomers		K24	5828-2	Utility pliers · long posterior band remover		H31	6400-1	Laboratory tweezers		K19	8813-1TC	Cutters · universal distal-end-cutter no hold		H4
5401-B	Spatulas for plaster and alginate		K26	5832	Cutters · multi-use wire cutter		H7	6400-2	Laboratory tweezers		K19	8814-1TC	Cutters · universal distal-end cutter		H5
5401-C	Spatulas for plaster and alginate		K26	5832-1TC	Cutters · multi-use wire cutter		H7	6600-2	Crucible tongs		K32	8815	Wire forming pliers · Johnson		H20
5401-F	Spatulas for plaster and alginate		K26	5833	Cutters · micro-miniature wire cutter		H8	6600-4	Crucible tongs		K32	8816	Wire forming pliers · precision pliers · Nance		H11
5401-G	Spatulas for plaster and alginate		K26	5833-1TC	Cutters · micro-miniature wire cutter		H8	6600-5	Crucible tongs		K32	8817	Wire forming pliers · loop pliers · Young		H14
5401-R	Spatulas for plaster and alginate		K26	5836	Cutters · distal end cutter		H9	6900E-A	Ortho/prothesis boxes · Blue		H37	8818	Wire forming pliers · universal bird beak pliers		H22
5401-V	Spatulas for plaster and alginate		K26	5836-1TC	Cutters · distal end cutter		H9	6900E-A	Ortho/prothesis boxes · Blue		H37 K27	8819	Wire forming pliers · Adams		H20
5500-10	Mixing bowls for plaster and alginate		K26	5837	Cutters · micro distal end cutter		H9	6900E-B	Ortho/prothesis boxes · White		H37 K27	8820-1	Wire forming pliers · mini · Aderer		H21
5500-12	Mixing bowls for plaster and alginate		K26	5838	Wire forming pliers · with cutter · Angle		H19	6900E-B	Ortho/prothesis boxes · White		H37 K27	8820-2	Wire forming pliers · standard · Aderer		H21
5500-14	Mixing bowls for plaster and alginate		K26	5860-1	Wire forming pliers · Mc Kellops		H18	6900E-C	Ortho/prothesis boxes · Light blue		H37 K27	8821	Wire forming pliers · bird beak pliers		H22
5500-16	Mixing bowls for plaster and alginate		K26	5861	Wire forming pliers · Johnson		H20	6900E-C	Ortho/prothesis boxes · Light blue		H37 K27 K27	8822-1	Wire forming pliers · universal pliers · How		H23
5501-10	Mixing bowls for plaster and alginate		K26	5862	Wire forming pliers · loop pliers · Nance		H15	7000-6	Ceramic sculpturing brushes		K20	8822-2	Wire forming pliers · curved · How		H23
5501-12	Mixing bowls for plaster and alginate		K26	5863	Wire forming pliers · Young		H14	7000-7	Ceramic sculpturing brushes		K20	8823	Wire forming pliers · Schwarz		H25
5501-14	Mixing bowls for plaster and alginate		K26	5864	Wire forming pliers · flat bending pliers		H18	7000-8	Ceramic sculpturing brushes		K20	8824-1TC	Cutters · mini ligatures cutter		H6
5501-16	Mixing bowls for plaster and alginate		K26	5865	Wire forming pliers · short rounded jaws pliers		H19	7001-0	Ceramic sculpturing brushes		K20	8825	Wire forming pliers · hammerhead NiTi pliers		H25
5600-1	Crown scissors · straight, one blade serrated		F45 K28	5866	Wire forming pliers · Angle		H19	7001-1	Ceramic sculpturing brushes		K20				
				5867-1	Wire forming pliers · Adams		H20	7001-3	Ceramic sculpturing brushes		K20				
				5867-2	Wire forming pliers · Adams		H20	7002-4	Ceramic sculpturing brushes		K20				

code	description	handle	page	code	description	handle	page	code	description	handle	page	code	description	handle	page	
8826-1TC	Cutters · distal end flush cutter		H5	AL2724-2	Aluminum containers for instrument trays		I13	AL2760-2	Burs holder · aluminum, suitable for steam sterilizing - with rim, 24 holes CA		E34 I17	LV1807-06MF	Gracey curettes - MF · Gracey	Leonardo Light LV	G13	
8827-1TC	Cutters · micro ligatures cutter 15°		H6	AL2724-3	Aluminum containers for instrument trays		I13	AL2760-3	Burs holder · aluminum, suitable for steam sterilizing - with rim, 24 holes FG/CA		E34 I17	LV1807-08	Gracey curettes · Gracey	Leonardo Light LV	G11	
8828-1TC	Utility pliers · universal band splitter		H33	AL2724-4	Aluminum containers for instrument trays		I13	AL2760-U	Burs holder · lid		I17	LV1807-08AF	Gracey curettes - AF · Gracey	Leonardo Light LV	G12	
8829	Wire forming pliers · Jarabak		H27	AL2725	Endodontic articles		I16	AL2761-1	Burs holder · with rim, 36 holes FG		I17	LV1807-08MF	Gracey curettes - MF · Gracey	Leonardo Light LV	G13	
8830	Wire forming pliers · V-stop		H27	AL2727-1	Plastic trays		A10	AL2761-2	Burs holder · with rim, 36 holes CA		I17	LV1807-10	Gracey curettes · Gracey	Leonardo Light LV	G11	
8831	Utility pliers · adhesive removing pliers		H32	AL2727-1AZ	Plastic trays		A10	AL2761-3	Burs holder · with rim, 36 holes FG/CA		I17	LV1807-11MD	Gracey curettes · Gracey	Leonardo Light LV	G11	
8831-1P	Utility pliers		H32	AL2727-1CZ	Plastic trays		A10	AL2761-U	Burs holder · lid		E34 I17	LV1807-12	Gracey curettes · Gracey	Leonardo Light LV	G11	
8832	Bracket placement marker		H36	AL2727-1GZ	Plastic trays		A10	AL2762-1	Burs holder · aluminum, suitable for steam sterilizing - 48 holes FG		I17	LV1807-12AF	Gracey curettes - AF · Gracey	Leonardo Light LV	G12	
9002	Case for instruments and pliers		D71	AL2727-1OZ	Plastic trays		A10	AL2762-2	Burs holder · aluminum, suitable for steam sterilizing - 48 holes CA		E34 I17	LV1807-12MF	Gracey curettes - MF · Gracey	Leonardo Light LV	G13	
9002-1	Insert for 6 extractive forceps		D71	AL2727-1Z	Plastic trays		A10	AL2762-3	Burs holder · aluminum, suitable for steam sterilizing - 48 holes FG/CA		I17	LV1807-13MD	Gracey curettes · Gracey	Leonardo Light LV	G11	
9002-2	Insert with elastic bands for 10 instruments		D71	AL2727-2	Plastic trays		A11	AL2763-1	Burs holder · with 7 bur holders, with lid		I17	LV1807-14	Gracey curettes · Gracey	Leonardo Light LV	G11	
9002-3	Insert with slots for 16 instruments		D71	AL2727-2AZ	Plastic trays		A11	AL2763-2	Burs holder · with 2 bur holders		I17	LV1807-14AF	Gracey curettes - AF · Gracey	Leonardo Light LV	G12	
AL2720-LA	Aluminum colour-coded instrument trays · Silver		I8	AL2727-2CZ	Plastic trays		A11	AL2764-A	Accessories · aluminum waste container		I18	LV1807-14MF	Gracey curettes - MF · Gracey	Leonardo Light LV	G13	
AL2720-LC	Aluminum colour-coded instrument trays · Light blue		I8	AL2727-2GZ	Plastic trays		A11	AL2764-C	Accessories · aluminum waste container		I18	LV1807-16	Gracey curettes · Gracey	Leonardo Light LV	G11	
AL2720-LO	Aluminum colour-coded instrument trays · Gold		I8	AL2727-2OZ	Plastic trays		A11	AL2764-O	Accessories · aluminum waste container		I18	LV1807-16AF	Gracey curettes - AF · Gracey	Leonardo Light LV	G12	
AL2720-LR	Aluminum colour-coded instrument trays · Red		I8	AL2727-2Z	Plastic trays		A11	AL2764-R	Accessories · aluminum waste container		I18	LV1807-16MF	Gracey curettes - MF · Gracey	Leonardo Light LV	G13	
AL2720-LV	Aluminum colour-coded instrument trays · Green		I8	AL2730-1	Aluminum insert frames · for 11 instruments		I8	AL2764-V	Accessories · aluminum waste container		I18	LV1807-18	Gracey curettes · Gracey	Leonardo Light LV	G11	
AL2720-UA	Aluminum colour-coded instrument trays · Silver		I8	AL2730-2	Aluminum insert frames · for 17 instruments		I8	AL2765-A	Accessories · aluminum cotton dispensers		I18	LV1826-T03	Curettes and Scalers · Taylor	Leonardo Light LV	G8	
AL2721-LA	Aluminum colour-coded instrument trays - perforated · Silver		I9	AL2730-3	Aluminum insert frames · for 10 instruments		I9	AL2765-C	Accessories · aluminum cotton dispensers		I18	LV1827-204S	Curettes and Scalers	Leonardo Light LV	G8	
AL2721-LC	Aluminum colour-coded instrument trays - perforated · Light blue		I9	AL2730-4	Aluminum insert frames · for 11 instruments		I9	AL2765-O	Accessories · aluminum cotton dispensers		I18	LV1829-CK6	Curettes and Scalers · Crane-Kaplan	Leonardo Light LV	G8	
AL2721-LO	Aluminum colour-coded instrument trays - perforated · Gold		I9	AL2731-1	Aluminum insert frames · for 8 instruments		I11	AL2765-R	Accessories · aluminum cotton dispensers		I18	MB026-1	Stainless steel compass		J19	
AL2721-LR	Aluminum colour-coded instrument trays - perforated · Red		I9	AL2731-2	Aluminum insert frames · for 4 instruments		I11	AL2766	Accessories · plastic box for used needles		A21 I19	MC0700-23	Single ended Explorers	Magic Color MC	B6	
AL2721-LV	Aluminum colour-coded instrument trays - perforated · Green		I9	AL2735	Mixing trays		A21	AL2767-1	Accessories · waste containers		A22 I18	MC0700-6	Single ended Explorers	Magic Color MC	B6	
AL2721-UA	Aluminum colour-coded instrument trays - perforated · Silver		I9	AL2736	Plastic mixing spatulas		A21	AL2767-2	Accessories · aluminium base for waste container		A22 I18	MC0700-9	Single ended Explorers	Magic Color MC	B6	
AL2722-LA	Aluminum colour-coded instrument trays · Silver		I10	AL2738-1	Plastic trays		A11	LV1807-02	Gracey curettes · Gracey	Leonardo Light LV	G11	MC0702-12	Periodontal pocket Probes	Magic Color MC	E32 G3	
AL2722-LC	Aluminum colour-coded instrument trays · Light blue		I10	AL2738-2	Plastic trays		A11	LV1807-02AF	Gracey curettes - AF · Gracey	Leonardo Light LV	G12	MC0702-OMS	Periodontal pocket Probes	Magic Color MC	G3	
AL2722-LO	Aluminum colour-coded instrument trays · Gold		I10	AL2739-1	Aluminum instrument tray rack · 6 compartments		I13	LV1807-02MF	Gracey curettes - MF · Gracey	Leonardo Light LV	G13	MC0703-14	Periodontal pocket Probes	Magic Color MC	G3	
AL2722-LR	Aluminum colour-coded instrument trays · Red		I10	AL2739-2	Aluminum instrument tray rack · 6 compartments		I13	LV1807-04	Gracey curettes · Gracey	Leonardo Light LV	G11	MC0704-11/12AF	Double ended Explorers	Magic Color MC	B8	
AL2722-LV	Aluminum colour-coded instrument trays · Green		I10	AL2740-1	Endodontic boxes		I14	LV1807-04AF	Gracey curettes - AF · Gracey	Leonardo Light LV	G12	MC0704-23D1	Double ended Explorers	Magic Color MC	B8	
AL2722-UA	Aluminum colour-coded instrument trays · Silver		I10	AL2740-2	Endodontic boxes		I14	LV1807-04MF	Gracey curettes - MF · Gracey	Leonardo Light LV	G13	MC0704-6D9	Double ended Explorers	Magic Color MC	B8	
AL2723-LA	Aluminum colour-coded instrument trays · Silver		I11	AL2740-3	Endodontic boxes		I14	LV1807-06	Gracey curettes · Gracey	Leonardo Light LV	G11	MC0707-GFW	Combination Explorers - Probes · Goldman-Fox Williams	Magic Color MC	B11	
AL2723-LC	Aluminum colour-coded instrument trays · Light blue		I11	AL2740-4	Endodontic boxes		I14	LV1807-06AF	Gracey curettes - AF · Gracey	Leonardo Light LV	G12	MC0708-2N	Double ended Explorers · Nabers	Magic Color MC	B11	
AL2723-LO	Aluminum colour-coded instrument trays · Gold		I11	AL2740-5	Endodontic boxes		I14									
AL2723-LR	Aluminum colour-coded instrument trays · Red		I11	AL2740-R	Endodontic boxes		I15									
AL2723-LV	Aluminum colour-coded instrument trays · Green		I11	AL2741-1	Endodontic boxes		I14									
AL2723-UA	Aluminum colour-coded instrument trays · Silver		I11	AL2741-2	Endodontic boxes		I14									
AL2724-1	Aluminum containers for instrument trays		I13	AL2742-1	Endodontic boxes		I15									
				AL2742-2	Endodontic boxes		I15									
				AL2742-3	Endodontic boxes		I15									
				AL2742-4	Endodontic boxes		I15									
				AL2742-5	Endodontic boxes		I15									
				AL2742-6	Endodontic boxes		I15									
				AL2742-7	Endodontic boxes		I15									
				AL2743	Endodontic boxes		I15									
				AL2744	Endodontic boxes		I15									
				AL2745-1A	Endodontic articles		I16									
				AL2745-2C	Endodontic articles		I16									
				AL2746-1	Endodontic articles		I16									
				AL2746-2	Endodontic articles		I16									
				AL2747-1A	Endodontic articles		I16									
				AL2760-1	Burs holder · with rim, 24 holes FG		I17									

code	description	handle	page	code	description	handle	page	code	description	handle	page	code	description	handle	page		
MC0800-1	Root-canal Spreaders	Magic Color MC	B12	MC1806-4RL	Curettes and Scalers · Columbia	Magic Color MC	G4	ML0704-6D9	Double ended Explorers	Leonardo ML	B8	ML1807-11MD	Gracey curettes · Gracey	Leonardo ML	G11		
MC0800-2	Root-canal Spreaders	Magic Color MC	B12	MC1807-02	Gracey curettes · Gracey	Magic Color MC	G11	ML0705-23W	Combination Explorers - Probes · Williams	Leonardo ML	B10	ML1807-12	Gracey curettes · Gracey	Leonardo ML	G11		
MC0800-3	Root-canal Spreaders	Magic Color MC	B12	MC1807-02MF	Gracey curettes - MF · Gracey	Magic Color MC	G13	ML0708-2N	Double ended Explorers · Nabers	Leonardo ML	B11	ML1807-12AF	Gracey curettes - AF · Gracey	Leonardo ML	G12		
MC0802-2	Root-canal Pluggers · Schilder	Magic Color MC	B14	MC1807-04	Gracey curettes · Gracey	Magic Color MC	G11	ML0800-1	Root-canal Spreaders	Leonardo ML	B12	ML1807-12MF	Gracey curettes - MF · Gracey	Leonardo ML	G13		
MC0802-4	Root-canal Pluggers · Schilder	Magic Color MC	B14	MC1807-04MF	Gracey curettes - MF · Gracey	Magic Color MC	G13	ML0800-2	Root-canal Spreaders	Leonardo ML	B12	ML1807-13MD	Gracey curettes · Gracey	Leonardo ML	G11		
MC0802-6	Root-canal Pluggers · Schilder	Magic Color MC	B14	MC1807-06	Gracey curettes · Gracey	Magic Color MC	G11	ML0800-3	Root-canal Spreaders	Leonardo ML	B12	ML1807-14	Gracey curettes · Gracey	Leonardo ML	G11		
MC0803-1	Root-canal Pluggers · Machtou	Magic Color MC	B13	MC1807-06MF	Gracey curettes - MF · Gracey	Magic Color MC	G13	ML0802-1	Root-canal Pluggers · Schilder	Leonardo ML	B14	ML1807-14AF	Gracey curettes - AF · Gracey	Leonardo ML	G12		
MC0803-2	Root-canal Pluggers · Machtou	Magic Color MC	B13	MC1807-08	Gracey curettes · Gracey	Magic Color MC	G11	ML0802-10	Root-canal Pluggers · Schilder	Leonardo ML	B14	ML1807-14MF	Gracey curettes - MF · Gracey	Leonardo ML	G13		
MC0803-3	Root-canal Pluggers · Machtou	Magic Color MC	B13	MC1807-08MF	Gracey curettes - MF · Gracey	Magic Color MC	G13	ML0802-2	Root-canal Pluggers · Schilder	Leonardo ML	B14	ML1807-16	Gracey curettes · Gracey	Leonardo ML	G11		
MC0803-4	Root-canal Pluggers · Machtou	Magic Color MC	B13	MC1807-10	Gracey curettes · Gracey	Magic Color MC	G11	ML0802-3	Root-canal Pluggers · Schilder	Leonardo ML	B14	ML1807-16AF	Gracey curettes - AF · Gracey	Leonardo ML	G12		
MC1102-1	Separating spatulas · Heidemann	Magic Color MC	F24	MC1807-12	Gracey curettes · Gracey	Magic Color MC	G11	ML0802-4	Root-canal Pluggers · Schilder	Leonardo ML	B14	ML1807-16MF	Gracey curettes - MF · Gracey	Leonardo ML	G13		
MC1102-2	Separating spatulas · Heidemann	Magic Color MC	F24	MC1807-12MF	Gracey curettes - MF · Gracey	Magic Color MC	G13	ML0802-5	Root-canal Pluggers · Schilder	Leonardo ML	B14	ML1807-18	Gracey curettes · Gracey	Leonardo ML	G11		
MC1202-2	Filling instruments - amalgam	Magic Color MC	F27	MC1807-14	Gracey curettes · Gracey	Magic Color MC	G11	ML0802-6	Root-canal Pluggers · Schilder	Leonardo ML	B14	ML1809-1	Curettes and Scalers · Goldman-Fox	Leonardo ML	G6		
MC1204-1	Filling instruments - Burnishers · Westcott	Magic Color MC	F31	MC1807-14MF	Gracey curettes - MF · Gracey	Magic Color MC	G13	ML0802-7	Root-canal Pluggers · Schilder	Leonardo ML	B14	ML1809-2	Curettes and Scalers · Goldman-Fox	Leonardo ML	G6		
MC1210-2	Filling instruments - plastic	Magic Color MC	F35	MC1807-16	Gracey curettes · Gracey	Magic Color MC	G11	ML0802-8	Root-canal Pluggers · Schilder	Leonardo ML	B14	ML1809-21	Curettes and Scalers · Goldman-Fox	Leonardo ML	G6		
MC1215-18	Filling instruments - Burnishers · Ball	Magic Color MC	F31	MC1807-16MF	Gracey curettes - MF · Gracey	Magic Color MC	G13	ML0802-9	Root-canal Pluggers · Schilder	Leonardo ML	B14	ML1809-3	Curettes and Scalers · Goldman-Fox	Leonardo ML	G6		
MC1215-27S	Filling instruments - Burnishers	Magic Color MC	F31	MC1807-18	Gracey curettes · Gracey	Magic Color MC	G11	ML0803-1	Root-canal Pluggers · Machtou	Leonardo ML	B13	ML1809-4	Curettes and Scalers · Goldman-Fox	Leonardo ML	G6		
MC1400-2	Filling instruments - amalgam · Markley	Magic Color MC	F29	MC1827-204S	Curettes and Scalers	Magic Color MC	G8	ML0803-2	Root-canal Pluggers · Machtou	Leonardo ML	B13	ML1809-5	Curettes and Scalers · Goldman-Fox	Leonardo ML	G6		
MC1500-02	Amalgam/wax carvers · Hollenback	Magic Color MC	F36 K13	MC1829-CK6S	Curettes and Scalers · Mini Crane-Kaplan	Magic Color MC	G8	ML0803-3	Root-canal Pluggers · Machtou	Leonardo ML	B13	ML1816-06	Gingivectomy knives · Buck	Leonardo ML	G24		
MC1510-1D	Composite instruments	Magic Color MC	F50	MC1902-1	Scalers · Towner Jacqueline	Magic Color MC	G14	ML0803-4	Root-canal Pluggers · Machtou	Leonardo ML	B13	ML1825-14S	Curettes and Scalers · Mc Call	Leonardo ML	G7		
MC1510-2D	Composite instruments	Magic Color MC	F50	MC2000-1	Bone curettes · Hemingway	Magic Color MC	C45 E21 G20	ML0804-1	Depth gauges		E32	ML1826-T03	Curettes and Scalers · Taylor	Leonardo ML	G8		
MC1510-3D	Composite instruments	Magic Color MC	F50	MC2000-2	Bone curettes · Hemingway	Magic Color MC	C45 E21 G20	ML1401-0	Filling instruments - amalgam · Foc	Leonardo ML	F30	ML1827-204S	Curettes and Scalers	Leonardo ML	G8		
MC1510-4D	Composite instruments	Magic Color MC	F50	MC2000-3	Bone curettes · Hemingway	Magic Color MC	C45 E21 G20	ML1401-0S	Filling instruments - amalgam · Foc	Leonardo ML	F30	ML1829-CK6	Curettes and Scalers · Crane-Kaplan	Leonardo ML	G8		
MC1510-5D	Composite instruments	Magic Color MC	F50	MC2101-B	Simple stem Mouth Mirrors - Handles	Magic Color MC	B19	ML1401-1	Filling instruments - amalgam · Foc	Leonardo ML	F30	ML1829-CK6S	Curettes and Scalers · Mini Crane-Kaplan	Leonardo ML	G8		
MC1600-1	Amalgam carvers · cleoid-discoid	Magic Color MC	F38	ML0700-17	Single ended Explorers	Leonardo ML	B6	ML1401-1S	Filling instruments - amalgam · Foc	Leonardo ML	F30	ML1830-YG08	Curettes and Scalers · Younger-Good	Leonardo ML	G8		
MC1700-1	Excavators - spoons	Magic Color MC	F13	ML0700-23	Single ended Explorers	Leonardo ML	B6	ML1401-2	Filling instruments - amalgam · Foc	Leonardo ML	F30	ML1845-1	Periotomes	Leonardo ML	D68 E29		
MC1700-2	Excavators - spoons	Magic Color MC	F13	ML0700-3R	Single ended Explorers · Rhein	Leonardo ML	B6	ML1401-2S	Filling instruments - amalgam · Foc	Leonardo ML	F30	ML1845-2	Periotomes	Leonardo ML	D68 E29		
MC1700-3	Excavators - spoons	Magic Color MC	F13	ML0700-6	Single ended Explorers	Leonardo ML	B6	ML1710-14	Excavators · SS. White	Leonardo ML	F16	ML1845-3	Periotomes	Leonardo ML	D68 E29		
MC1703-14	Excavators - spoons	Magic Color MC	F14	ML0700-8	Single ended Explorers	Leonardo ML	B6	ML1710-17	Excavators · SS. White	Leonardo ML	F16	ML1900-M23	Scalers · universal scaler	Leonardo ML	G14		
MC1704-17	Excavators - spoons	Magic Color MC	F14	ML0700-9	Single ended Explorers	Leonardo ML	B6	ML1710-18	Excavators · SS. White	Leonardo ML	F16	ML1902-1	Scalers · Towner Jacqueline	Leonardo ML	G14		
MC1806-14	Curettes and Scalers · Columbia	Magic Color MC	G4	ML0702-OMS	Periodontal pocket Probes · Novatech	Leonardo ML	G3	ML1710-19	Excavators · SS. White	Leonardo ML	F16	ML1902-1	Scalers · Towner	Leonardo ML	G14		
MC1806-2RL	Curettes and Scalers · Columbia	Magic Color MC	G4	ML0703-14	Periodontal pocket Probes · Williams	Leonardo ML	G3	ML1710-20	Excavators · SS. White	Leonardo ML	F16	ML1906-1	Scalers · Jacqueline	Leonardo ML	G15		
				ML0704-11/12AF	Double ended Explorers	Leonardo ML	B8	ML1710-5	Excavators · SS. White	Leonardo ML	F16	ML1906-2	Scalers · Jacqueline	Leonardo ML	G15		
				ML0704-23D1	Double ended Explorers	Leonardo ML	B8	ML1711-1	Excavators · Darby-Perry	Leonardo ML	F17	ML1906-3	Scalers · Jacqueline	Leonardo ML	G15		
				ML0704-6D2	Double ended Explorers	Leonardo ML	B9	ML1711-11	Excavators · Darby-Perry	Leonardo ML	F17	ML2000-1	Bone curettes · Hemingway	Leonardo ML	C45 E21 G20		
								ML1711-12	Excavators · Darby-Perry	Leonardo ML	F17	ML2000-2	Bone curettes · Hemingway	Leonardo ML	C45 E21 G20		
								ML1711-2	Excavators · Darby-Perry	Leonardo ML	F17	ML2000-3	Bone curettes · Hemingway	Leonardo ML	C45 E21 G20		
								ML1711-21	Excavators · Darby-Perry	Leonardo ML	F17	ML2000-4	Bone curettes · Hemingway	Leonardo ML	G20		
								ML1711-22	Excavators · Darby-Perry	Leonardo ML	F17	ML2001-85	Bone curettes · Lucas	Leonardo ML	G20		
								ML1711-243	Excavators - ASH	Leonardo ML	F15	ML2001-86	Bone curettes · Lucas	Leonardo ML	G20		
								ML1711-31	Excavators · Darby-Perry	Leonardo ML	F17	ML2001-87	Bone curettes · Lucas	Leonardo ML	G20		
								ML1711-32	Excavators · Darby-Perry	Leonardo ML	F17	ML2001-88	Bone curettes · Lucas	Leonardo ML	G20		
								ML1711-41	Excavators · Darby-Perry	Leonardo ML	F17	ML2101	Simple stem Mouth Mirrors - Handles	Leonardo ML	B19		
								ML1711-42	Excavators · Darby-Perry	Leonardo ML	F17	MV1851-PR3	Periosteals and Elevators · Prichard	Asa Light MV	E23 G16		
								ML1711-G2	Excavators - ASH	Leonardo ML	F15	MV2000-1	Bone curettes · Hemingway	Asa Light MV	C45 E21 G20		
								ML1803-D	Gingivectomy knives · Kirkland	Leonardo ML	G24	MV2000-2	Bone curettes · Hemingway	Asa Light MV	C45 E21 G20		
								ML1804-D	Gingivectomy knives · Orban	Leonardo ML	G24						
								ML1806-14	Curettes and Scalers · Columbia	Leonardo ML	G4						
								ML1806-2RL	Curettes and Scalers · Columbia	Leonardo ML	G4						
								ML1806-4RL	Curettes and Scalers · Columbia	Leonardo ML	G4						
								ML1807-02	Gracey curettes · Gracey	Leonardo ML	G11						
								ML1807-02AF	Gracey curettes - AF · Gracey	Leonardo ML	G12						
								ML1807-02MF	Gracey curettes - MF · Gracey	Leonardo ML	G13						
								ML1807-04	Gracey curettes · Gracey	Leonardo ML	G11						
								ML1807-04AF	Gracey curettes - AF · Gracey	Leonardo ML	G12						
								ML1807-04MF	Gracey curettes - MF · Gracey	Leonardo ML	G13						
								ML1807-06	Gracey curettes · Gracey	Leonardo ML	G11						
								ML1807-06AF	Gracey curettes - AF · Gracey	Leonardo ML	G12						
								ML1807-06MF	Gracey curettes - MF · Gracey	Leonardo ML	G13						
								ML1807-08	Gracey curettes · Gracey	Leonardo ML	G11						
								ML1807-08AF	Gracey curettes - AF · Gracey	Leonardo ML	G12						
								ML1807-08MF	Gracey curettes - MF · Gracey	Leonardo ML	G13						
								ML1807-10	Gracey curettes · Gracey	Leonardo ML	G11						

code	description	handle	page	code	description	handle	page	code	description	handle	page	code	description	handle	page
MV2000-3	Bone curettes · Hemingway	Asa Light MV	C45 E21 G20	MV1204-1	Filling instruments - Burnishers · Westcott	Asa Light MV	F31	MV1400-1	Filling instruments - amalgam · Markley	Asa Light MV	F29	MV1704-17	Excavators - spoons	Asa Light MV	F14
MV0704-16D1	Double ended Explorers	Asa Light MV	B8	MV1204-2	Filling instruments - Burnishers · Westcott	Asa Light MV	F31	MV1400-2	Filling instruments - amalgam · Markley	Asa Light MV	F29	MV1704-17W	Excavators - oval spoons	Asa Light MV	F15
MV0704-16D2	Double ended Explorers	Asa Light MV	B8	MV1205-1	Filling instruments - amalgam · Ward	Asa Light MV	F28	MV1400-3	Filling instruments - amalgam · Markley	Asa Light MV	F29	MV1705-18	Excavators - spoons	Asa Light MV	F14
MV0704-23D1	Double ended Explorers	Asa Light MV	B8	MV1205-2	Filling instruments - amalgam · Ward	Asa Light MV	F28	MV1400-4	Filling instruments - amalgam · Markley	Asa Light MV	F29	MV1705-18W	Excavators - oval spoons	Asa Light MV	F15
MV0704-23D2	Double ended Explorers	Asa Light MV	B8	MV1206-1	Filling instruments - plastic	Asa Light MV	F34	MV1400-5	Filling instruments - amalgam · Markley	Asa Light MV	F29	MV1706-19	Excavators - spoons	Asa Light MV	F14
MV0704-UT1	Double ended Explorers · Cattoni	Asa Light MV	B8	MV1206-2	Filling instruments - plastic	Asa Light MV	F34	MV1400-6	Filling instruments - amalgam · Markley	Asa Light MV	F29	MV1706-19W	Excavators - oval spoons	Asa Light MV	F15
MV0705-16GF	Combination Explorers - Probes · Goldman-Fox	Asa Light MV	B10	MV1207-1	Filling instruments - plastic	Asa Light MV	F34	MV1500-02	Amalgam/wax carvers · Hollenback	Asa Light MV	F36 K13	MV1707-39	Excavators - spoons	Asa Light MV	F14
MV0705-16W	Combination Explorers - Probes · Williams	Asa Light MV	B10	MV1207-2	Filling instruments - plastic	Asa Light MV	F34	MV1500-3	Amalgam/wax carvers · Hollenback	Asa Light MV	F36 K13	MV1709-31L	Excavators - spoons	Asa Light MV	B15 F14
MV0705-17GF	Combination Explorers - Probes · Goldman-Fox	Asa Light MV	B10	MV1208-1	Filling instruments - plastic	Asa Light MV	F34	MV1500-3S	Amalgam/wax carvers · Hollenback	Asa Light MV	F36 K13	MV1709-32L	Excavators - spoons	Asa Light MV	B15 F14
MV0705-17UM	Combination Explorers - Probes · University of Michigan	Asa Light MV	B10	MV1208-2	Filling instruments - plastic	Asa Light MV	F34	MV1501-1	Amalgam/wax carvers · Ward	Asa Light MV	F36 K13	MV1709-33L	Excavators - spoons	Asa Light MV	B15 F14
MV0705-17W	Combination Explorers - Probes · Williams	Asa Light MV	B11	MV1208-3	Filling instruments - plastic	Asa Light MV	F34	MV1501-1S	Amalgam/wax carvers · Ward	Asa Light MV	F36 K13	MV1801-D	Chisels · TG	Asa Light MV	G26
MV0705-23GF	Combination Explorers - Probes · Goldman-Fox	Asa Light MV	B10	MV1209-1	Filling instruments - plastic	Asa Light MV	F34	MV1501-2	Amalgam/wax carvers · Ward	Asa Light MV	F36 K13	MV1802-3	Chisels · Ochsenbein	Asa Light MV	G26
MV0705-23UM	Combination Explorers - Probes · University of Michigan	Asa Light MV	B10	MV1209-2	Filling instruments - plastic	Asa Light MV	F34	MV1502-1	Amalgam/wax carvers · Frahm	Asa Light MV	F36 K13	MV1802-4	Chisels · Ochsenbein	Asa Light MV	G26
MV0705-23W	Combination Explorers - Probes · Williams	Asa Light MV	B10	MV1209-3	Filling instruments - plastic	Asa Light MV	F34	MV1507-8	Amalgam carvers	Asa Light MV	F37	MV1803-D	Gingivectomy knives · Kirkland	Asa Light MV	G24
MV0705-3GF	Root-canal Explorers · Goldman-Fox	Asa Light MV	B10	MV1210-1	Filling instruments - plastic	Asa Light MV	F35	MV1600-1	Amalgam carvers · cleoid-discoid	Asa Light MV	F38	MV1804-D	Gingivectomy knives · Orban	Asa Light MV	G24
MV0706-2311	Combination Explorers - Probes	Asa Light MV	B10	MV1210-2	Filling instruments - plastic	Asa Light MV	F35	MV1600-2	Amalgam carvers · cleoid-discoid	Asa Light MV	F38	MV1805-02	Curettes and Scalers · Langer	Asa Light MV	G5
MV0706-2312	Combination Explorers - Probes	Asa Light MV	B11	MV1210-3	Filling instruments - plastic	Asa Light MV	F35	MV1600-3	Amalgam carvers · cleoid-discoid	Asa Light MV	F38	MV1805-04	Curettes and Scalers · Langer	Asa Light MV	G5
MV0707-GFW	Combination Explorers - Probes · Goldman-Fox Williams	Asa Light MV	B11	MV1211-0T	Filling instruments - amalgam · Tanner	Asa Light MV	F28	MV1601-1	Cavity preparation instruments - margin trimmers · distal · Black/26	Asa Light MV	F18	MV1806-02	Curettes and Scalers	Asa Light MV	G4
MV0708-1N	Double ended Explorers · Nabers	Asa Light MV	B11	MV1211-1T	Filling instruments - amalgam · Tanner	Asa Light MV	F28	MV1601-2	Cavity preparation instruments - margin trimmers · distal · Black/27	Asa Light MV	F19	MV1806-14	Curettes and Scalers · Columbia	Asa Light MV	G4
MV0708-2N	Double ended Explorers · Nabers	Asa Light MV	B11	MV1211-2T	Filling instruments - amalgam · Tanner	Asa Light MV	F28	MV1601-3	Cavity preparation instruments - margin trimmers · distal · Black/28	Asa Light MV	F19	MV1806-2RL	Curettes and Scalers · Columbia	Asa Light MV	G4
MV0709-2	Double ended Explorers	Asa Light MV	B8	MV1211-3T	Filling instruments - amalgam · Tanner	Asa Light MV	F28	MV1601-4	Cavity preparation instruments - margin trimmers · mesial · Black/29	Asa Light MV	F19	MV1806-412	Curettes and Scalers · Columbia	Asa Light MV	G4
MV0709-2A	Double ended Explorers	Asa Light MV	B8	MV1212-01	Filling instruments - amalgam · Marquette	Asa Light MV	F28	MV1602-1	Cavity preparation instruments - margin trimmers · distal · Black/78	Asa Light MV	F19	MV1806-414	Curettes and Scalers · Columbia	Asa Light MV	G4
MV0709-3	Double ended Explorers	Asa Light MV	B9	MV1213-H1	Filling instruments - amalgam · Hollenback	Asa Light MV	F28	MV1602-2	Cavity preparation instruments - margin trimmers · mesial · Black/79-80	Asa Light MV	F19	MV1806-4RL	Curettes and Scalers · Columbia	Asa Light MV	G4
MV0710-6D1	Root-canal Explorers	Asa Light MV	B9	MV1213-H2	Filling instruments - amalgam · Hollenback	Asa Light MV	F28	MV1603-1	Cavity preparation instruments - hatchets · Black/53-54	Asa Light MV	F18	MV1807-02	Gracey curettes · Gracey	Asa Light MV	G11
MV0710-6D2	Root-canal Explorers	Asa Light MV	B9	MV1213-H3	Filling instruments - amalgam · Hollenback	Asa Light MV	F28	MV1603-2	Cavity preparation instruments - hatchets · Black/51-52	Asa Light MV	F18	MV1807-04	Gracey curettes · Gracey	Asa Light MV	G11
MV0710-6D3	Root-canal Explorers	Asa Light MV	B9	MV1213-H4	Filling instruments - amalgam · Hollenback	Asa Light MV	F28	MV1604-02	Cavity preparation instruments - chisels · Wedelstaet	Asa Light MV	F18	MV1807-06	Gracey curettes · Gracey	Asa Light MV	G11
MV1102-1	Separating spatulas · Heidemann	Asa Light MV	F24	MV1214-2	Filling instruments - Burnishers · Ladmore	Asa Light MV	F31	MV1604-04	Cavity preparation instruments - chisels · Wedelstaet	Asa Light MV	F18	MV1807-08	Gracey curettes · Gracey	Asa Light MV	G11
MV1102-2	Separating spatulas · Heidemann	Asa Light MV	F24	MV1214-3	Filling instruments - Burnishers · Ladmore	Asa Light MV	F31	MV1604-06	Cavity preparation instruments - chisels · Wedelstaet	Asa Light MV	F18	MV1807-10	Gracey curettes · Gracey	Asa Light MV	G11
MV1102-3	Separating spatulas · Heidemann	Asa Light MV	F24	MV1215-18	Filling instruments - Burnishers · Ball	Asa Light MV	F31	MV1700-0	Excavators - spoons	Asa Light MV	F13	MV1807-11MD	Gracey curettes · Gracey	Asa Light MV	G11
MV1200-1	Filling instruments - amalgam	Asa Light MV	F26	MV1215-27S	Filling instruments - Burnishers · Ball	Asa Light MV	F31	MV1700-1	Excavators - spoons	Asa Light MV	F13	MV1807-12	Gracey curettes · Gracey	Asa Light MV	G11
MV1200-2	Filling instruments - amalgam	Asa Light MV	F26	MV1215-29	Filling instruments - Burnishers · Ball	Asa Light MV	F31	MV1700-2	Excavators - spoons	Asa Light MV	F13	MV1807-13MD	Gracey curettes · Gracey	Asa Light MV	G11
MV1200-3	Filling instruments - amalgam	Asa Light MV	F26	MV1216-1	Filling instruments - plastic · Woodson	Asa Light MV	F35	MV1700-3	Excavators - spoons	Asa Light MV	F13	MV1807-14	Gracey curettes · Gracey	Asa Light MV	G11
MV1200-4	Filling instruments - amalgam	Asa Light MV	F26	MV1216-2	Filling instruments - plastic · Woodson	Asa Light MV	F35	MV1700-4	Excavators - spoons	Asa Light MV	F13	MV1809-1	Curettes and Scalers · Goldman-Fox	Asa Light MV	G6
MV1200-5	Filling instruments - amalgam	Asa Light MV	F26	MV1216-3	Filling instruments - plastic · Woodson	Asa Light MV	F35	MV1701-1	Excavators - spoons	Asa Light MV	F13	MV1809-2	Curettes and Scalers · Goldman-Fox	Asa Light MV	G6
MV1201-1	Filling instruments - amalgam	Asa Light MV	F26	MV1217-11	Filling instruments - plastic	Asa Light MV	F35	MV1701-2	Excavators - spoons	Asa Light MV	F13	MV1809-21	Curettes and Scalers · Goldman-Fox	Asa Light MV	G6
MV1201-1L	Filling instruments - amalgam	Asa Light MV	F26	MV1218-6	Filling instruments - plastic	Asa Light MV	F35	MV1702-6	Excavators - spoons	Asa Light MV	F14	MV1809-3	Curettes and Scalers · Goldman-Fox	Asa Light MV	G6
MV1201-2	Filling instruments - amalgam	Asa Light MV	F26	MV1219-179	Filling instruments - plastic	Asa Light MV	F35	MV1703-14	Excavators - spoons	Asa Light MV	F14	MV1809-4	Curettes and Scalers · Goldman-Fox	Asa Light MV	G6
MV1201-2L	Filling instruments - amalgam	Asa Light MV	F26	MV1220-B2	Filling instruments - Burnishers	Asa Light MV	F31					MV1809-5	Curettes and Scalers · Goldman-Fox	Asa Light MV	G6
MV1201-3	Filling instruments - amalgam	Asa Light MV	F26	MV1221-31	Filling instruments - Burnishers	Asa Light MV	F31					MV1809-6	Curettes and Scalers · Goldman-Fox	Asa Light MV	G6
MV1201-3L	Filling instruments - amalgam	Asa Light MV	F26	MV1230-1	Bone compactors		E35					MV1810-07	Files · Hirschfeld	Asa Light MV	G22
MV1202-1	Filling instruments - amalgam	Asa Light MV	F27	MV1230-2	Bone compactors		E35					MV1811-37	Chisels · back-action · Rhodes	Asa Light MV	G26
MV1202-1L	Filling instruments - amalgam	Asa Light MV	F27	MV1231-1	Bone applicator	Asa Light MV	E29					MV1812-02S	Files · Sugarman	Asa Light MV	G22
MV1202-2	Filling instruments - amalgam	Asa Light MV	F27	MV1301	Operative instruments	Asa Light MV	F39					MV1812-04S	Files · Sugarman	Asa Light MV	G22
MV1202-2L	Filling instruments - amalgam	Asa Light MV	F27	MV1302	Operative instruments	Asa Light MV	F39					MV1813-10	Files · Schluger	Asa Light MV	G22
MV1202-3	Filling instruments - amalgam	Asa Light MV	F27									MV1824-14	Curettes and Scalers · anterior · Indiana University	Asa Light MV	G5
MV1202-3L	Filling instruments - amalgam	Asa Light MV	F27									MV1824-18	Curettes and Scalers · posterior · Indiana University	Asa Light MV	G5
MV1202-4	Filling instruments - amalgam	Asa Light MV	F27									MV1825-12	Curettes and Scalers · Mc Call	Asa Light MV	G7
MV1202-4L	Filling instruments - amalgam	Asa Light MV	F27									MV1825-14	Curettes and Scalers · Mc Call	Asa Light MV	G7
MV1203-1	Filling instruments - amalgam	Asa Light MV	F27									MV1825-14S	Curettes and Scalers · Mc Call	Asa Light MV	G7
MV1203-2	Filling instruments - amalgam	Asa Light MV	F27									MV1825-18S	Curettes and Scalers · Mc Call	Asa Light MV	G7
MV1203-3	Filling instruments - amalgam	Asa Light MV	F27									MV1825-20	Curettes and Scalers · Mc Call	Asa Light MV	G7
												MV1826-T03	Curettes and Scalers · Taylor	Asa Light MV	G8
												MV1827-204S	Curettes and Scalers	Asa Light MV	G8
												MV1829-CK6	Curettes and Scalers · Crane-Kaplan	Asa Light MV	G8
												MV1830-YG08	Curettes and Scalers · Younger-Good	Asa Light MV	G8
												MV1831-32	Curettes and Scalers · Jacquette	Asa Light MV	G9
												MV1831-33	Curettes and Scalers · Jacquette	Asa Light MV	G9
												MV1831-35	Curettes and Scalers · Jacquette	Asa Light MV	G9

code	description	handle	page	code	description	handle	page	code	description	handle	page	code	description	handle	page
<a href="#">MV1831-38</a>	Curettes and Scalers · Jacquette	Asa Light MV	G9	<a href="#">PR1857-1</a>	Exciser	Perfection	D68	<a href="#">S1700-2</a>	Excavators - spoons	Asa60	F13	<a href="#">S2801A-12</a>	Perforated stainless steel impression trays - ANATOMIC		J15
<a href="#">MV1850-9A</a>	Periosteals and Elevators · Allen	Asa Light MV	E23				E22	<a href="#">S1700-3</a>	Excavators - spoons	Asa60	F13				
			G16	<a href="#">PR1859-1</a>	Sinus lift instruments	Perfection	E14	<a href="#">S1700-4</a>	Excavators - spoons	Asa60	F13	<a href="#">S2801A-6</a>	Perforated stainless steel impression trays - ANATOMIC		J15
<a href="#">MV1850-GF</a>	Periosteals and Elevators · GF Goldman-Fox	Asa Light MV	E22	<a href="#">PR1859-2</a>	Sinus lift instruments	Perfection	E14	<a href="#">S1710-6</a>	Excavators · SS. White	Asa60	F16				
			G16	<a href="#">S0100-1</a>	Extracting forceps		D4	<a href="#">S1800-23</a>	Periodontal instruments kit		G37	<a href="#">S2801A-8</a>	Perforated stainless steel impression trays - ANATOMIC		J15
<a href="#">MV1850-M7</a>	Periosteals and Elevators · Molt	Asa Light MV	E23	<a href="#">S0100-2</a>	Extracting forceps		D5	<a href="#">S1806</a>	Curettes and Scalers	Asa60	G4				
			G16	<a href="#">S0100-3</a>	Extraction and oral surgery kit		D70	<a href="#">S1807</a>	Gracey curettes	Asa60	G34	<a href="#">S2802-12</a>	Non-perforated stainless steel impression trays		J33
<a href="#">MV1850-M8</a>	Periosteals and Elevators · Molt	Asa Light MV	E23	<a href="#">S0100-4</a>	Extraction and oral surgery kit		D70	<a href="#">S1807-3</a>	Gracey curettes	Asa60	G34				
			G16	<a href="#">S0110</a>	Extracting forceps for children		D38	<a href="#">S1807AF</a>	Gracey curettes	Asa60	G34	<a href="#">S2802-6</a>	Non-perforated stainless steel impression trays		J33
<a href="#">MV1850-M9</a>	Periosteals and Elevators · Molt	Asa Light MV	E23	<a href="#">S0112</a>	Extracting forceps for children - Klein pattern		D39	<a href="#">S1807AF-3</a>	Gracey curettes	Asa60	G34				
			G16					<a href="#">S1807MF</a>	Gracey curettes	Asa60	G34	<a href="#">S2802-8</a>	Non-perforated stainless steel impression trays		J33
<a href="#">MV1851-2</a>	Periosteals and Elevators · Hourigan	Asa Light MV	E23	<a href="#">S0200-10</a>	Root elevators		D49	<a href="#">S1807MF-3</a>	Gracey curettes	Asa60	G34				
			G16	<a href="#">S0200-6</a>	Root elevators		D47	<a href="#">S1809</a>	Curettes and Scalers	Asa60	G6	<a href="#">S2802A-12</a>	Non-perforated stainless steel impression trays - ANATOMIC		J35
<a href="#">MV1852-1</a>	Periosteals and Elevators · Hopkins	Asa Light MV	E24	<a href="#">S0244-6</a>	Root elevators		D50	<a href="#">S1899</a>	Grinding stones		G33				
			G17	<a href="#">S0296</a>	Syndesmotomes instruments kit		D69	<a href="#">S1899</a>	Periodontal instruments kit		G35	<a href="#">S2802A-6</a>	Non-perforated stainless steel impression trays - ANATOMIC		J35
<a href="#">MV1852-2</a>	Periosteals and Elevators · Hopkins	Asa Light MV	E24	<a href="#">S0296-1</a>	Syndesmotomes instruments kit		D69	<a href="#">S2100</a>	Simple stem Mouth Mirrors - Handles · set of 5	Octagonal	B19				
			G17	<a href="#">S0352</a>	Scalpel handle and remover kit		C24					<a href="#">S2802A-8</a>	Non-perforated stainless steel impression trays - ANATOMIC		J35
<a href="#">MV1853-15</a>	Periosteals and Elevators · Freer	Asa Light MV	E24				E9	<a href="#">S2101</a>	Simple stem Mouth Mirrors - Handles · set of 5	Asa60	B19				
			G17	<a href="#">S0495-6</a>	Osteotomes		E19					<a href="#">S2803-10</a>	Non-perforated stainless steel impression trays - NEW SUPER		J21
<a href="#">MV1853-16</a>	Periosteals and Elevators · Freer	Asa Light MV	E24	<a href="#">S0498-8</a>	Implant surgery instruments · sinus lift mini kit		E40	<a href="#">S2102-IN</a>	Simple stem Mouth Mirrors - Handles · set of 5, hollow	Exagonal	B19				
			G17					<a href="#">S2002-6</a>	Mirrors (mouth) parallelometer with handle	Asa60	B19	<a href="#">S2803S-10</a>	Non-perforated stainless steel impression trays - NEW SUPER high grip		J31
<a href="#">MV1854-3</a>	Periosteals and Elevators · Mead	Asa Light MV	E24	<a href="#">S0600-1</a>	Periodontal first examination kit		G36								
			G17	<a href="#">S0600-23</a>	First examination instruments kit		B22	<a href="#">S2700</a>	Stainless steel instrument trays · for 7 instruments		I6	<a href="#">S2804-12</a>	Perforated stainless steel impression trays - PERMA-LOCK		J5
<a href="#">MV1855-1</a>	Sinus lift instruments	Asa Light MV	E15	<a href="#">S0600-6</a>	First examination instruments kit		B22								
<a href="#">MV1855-2</a>	Sinus lift instruments	Asa Light MV	E15	<a href="#">S0600-9</a>	First examination instruments kit		B22	<a href="#">S2702</a>	Stainless steel instrument trays · for 7 instruments		I6	<a href="#">S2804-6</a>	Perforated stainless steel impression trays - PERMA-LOCK		J5
<a href="#">MV1855-3</a>	Sinus lift instruments	Asa Light MV	E15	<a href="#">S0600-M</a>	First examination instruments kit		A21								
<a href="#">MV1855-4</a>	Sinus lift instruments	Asa Light MV	E15	<a href="#">S0601-1</a>	Cotton and dressing pliers · Flagg		B4	<a href="#">S2720-1</a>	Stainless steel instrument trays · for 16 instruments		I5	<a href="#">S2804-8</a>	Perforated stainless steel impression trays - PERMA-LOCK		J5
<a href="#">MV1855-5</a>	Sinus lift instruments	Asa Light MV	E15	<a href="#">S0601-2</a>	Cotton and dressing pliers · London-College		B4								
<a href="#">MV1855-6</a>	Sinus lift instruments	Asa Light MV	E15					<a href="#">S2720-2</a>	Stainless steel instrument trays · for 23 instruments		I5	<a href="#">S2804A-12</a>	Perforated stainless steel impression trays - PERMA-LOCK anatomic		J7
<a href="#">MV1856-1</a>	Sinus lift instruments	Asa Light MV	E13	<a href="#">S0601-3</a>	Cotton and dressing pliers · Meriam		B4								
<a href="#">MV1856-2</a>	Sinus lift instruments	Asa Light MV	E13	<a href="#">S0645</a>	Tissue pliers set		C42	<a href="#">S2721-1</a>	Stainless steel instrument trays · for 16 instruments		I4	<a href="#">S2804A-6</a>	Perforated stainless steel impression trays - PERMA-LOCK anatomic		J7
<a href="#">MV1856-3</a>	Sinus lift instruments	Asa Light MV	E13	<a href="#">S0690-2</a>	Ultralight Retractor		B21								
<a href="#">MV1856-4</a>	Sinus lift instruments	Asa Light MV	E13	<a href="#">S0700-11</a>	Single ended Explorers	Asa60	B7	<a href="#">S2721-2</a>	Stainless steel instrument trays · for 23 instruments		I4	<a href="#">S2804A-8</a>	Perforated stainless steel impression trays - PERMA-LOCK anatomic		J7
<a href="#">MV1856-5</a>	Sinus lift instruments	Asa Light MV	E13	<a href="#">S0700-16</a>	Single ended Explorers	Asa60	B7								
<a href="#">MV1856-6</a>	Sinus lift instruments	Asa Light MV	E14	<a href="#">S0700-23</a>	Single ended Explorers	Asa60	B7	<a href="#">S2722-1</a>	Stainless steel instrument trays · for 16 instruments		I4				
<a href="#">MV1856-7</a>	Sinus lift instruments	Asa Light MV	E14	<a href="#">S0700-6</a>	Single ended Explorers	Asa60	B7								
<a href="#">MV1856-8</a>	Sinus lift instruments	Asa Light MV	E14	<a href="#">S0700-9</a>	Single ended Explorers	Asa60	B7	<a href="#">S2722-2</a>	Stainless steel instrument trays · for 23 instruments		I4	<a href="#">S2804S-12</a>	Perforated stainless steel impression trays - PERMA-LOCK high grip		J9
<a href="#">MV1883</a>	Membrane placement instrument · Buser	Asa Light MV	E31	<a href="#">S0702L-23</a>	Endodontic kit · Boston university		B25								
				<a href="#">S0702L-7</a>	Endodontic kit · 7 Laser System instruments		B25	<a href="#">S2723-1</a>	Stainless steel instrument trays · for 8 instruments		I7	<a href="#">S2804S-6</a>	Perforated stainless steel impression trays - PERMA-LOCK high grip		J9
<a href="#">MV1902-1</a>	Scalers · Towner Jacquette	Asa Light MV	G14	<a href="#">S0800</a>	Endodontic kit		B25								
<a href="#">MV1902-2</a>	Scalers · Towner Jacquette	Asa Light MV	G14	<a href="#">S0903-1</a>	Cement spatulas		F22	<a href="#">S2723-2</a>	Stainless steel instrument trays · for 4 instruments		I7				
<a href="#">MV1904-H5</a>	Scalers	Asa Light MV	G14	<a href="#">S0903-2</a>	Cement spatulas		F22								
<a href="#">MV1904-H6</a>	Scalers	Asa Light MV	G14	<a href="#">S0903-3</a>	Cement spatulas		F22	<a href="#">S2724-1</a>	Stainless steel instrument trays · for 8 instruments		I7	<a href="#">S2804S-8</a>	Perforated stainless steel impression trays - PERMA-LOCK high grip		J9
<a href="#">MV1905-02</a>	Scalers	Asa Light MV	G14	<a href="#">S1102-1</a>	Separating spatulas - AsaLady · Heidemann	Asa60	F24								
<a href="#">MV2000-4</a>	Bone curettes · Hemingway	Asa Light MV	G20	<a href="#">S1102-2</a>	Separating spatulas - AsaLady · Heidemann	Asa60	F24	<a href="#">S2724-2</a>	Stainless steel instrument trays · for 4 instruments		I7				
<a href="#">MV2001-85</a>	Bone curettes · Lucas	Asa Light MV	G20												
<a href="#">MV2001-86</a>	Bone curettes · Lucas	Asa Light MV	G20	<a href="#">S1102-3</a>	Separating spatulas - AsaLady · Heidemann	Asa60	F24	<a href="#">S2731-1</a>	Stainless steel rubber dam clamp tray with 8 different clamps		F11	<a href="#">S2806-8</a>	Perforated stainless steel impression trays - edentulous		J11
<a href="#">MV2001-87</a>	Bone curettes · Lucas	Asa Light MV	G20												
<a href="#">MV2001-88</a>	Bone curettes · Lucas	Asa Light MV	G20	<a href="#">S1200-1</a>	Filling instruments - amalgam	Asa60	F26	<a href="#">S2731-12</a>	Stainless steel rubber dam clamp tray with 12 different clamps		F11	<a href="#">S2807-12</a>	Non-perforated stainless steel impression trays - PERMA-LOCK		J23
<a href="#">MV2002-1</a>	Bone files · Wahl	Asa Light MV	G23	<a href="#">S1200-2</a>	Filling instruments - amalgam	Asa60	F26								
<a href="#">MV2002-2</a>	Bone files · Wahl	Asa Light MV	G23	<a href="#">S1200-3</a>	Filling instruments - amalgam	Asa60	F26	<a href="#">S2760-A</a>	Colored silicone burs holder · Orange		E34	<a href="#">S2807-6</a>	Non-perforated stainless steel impression trays - PERMA-LOCK		J23
<a href="#">PR0460-15TC</a>	Needle holders · with curved jaws · Castroviejo TC		C18	<a href="#">S1200-4</a>	Filling instruments - amalgam	Asa60	F26								
			E6	<a href="#">S1200-5</a>	Filling instruments - amalgam	Asa60	F26	<a href="#">S2760-C</a>	Colored silicone burs holder · Blue		E34				
<a href="#">PR0625-2</a>	Suture pliers		C40	<a href="#">S1200T</a>	Filling instruments - amalgam	Asa60	F25								
			E36	<a href="#">S1220</a>	Composite instruments · Felt	Alu60	F32	<a href="#">S2780-IMP</a>	Implant surgery instruments		E39	<a href="#">S2807A-12</a>	Non-perforated stainless steel impression trays - PERMA-LOCK anatomic		J25
<a href="#">PR0625-3</a>	Suture pliers		C40	<a href="#">S1222-15</a>	Composite instruments		F51	<a href="#">S2800-12</a>	Perforated aluminum impression trays		J37				
			E36	<a href="#">S1222-7</a>	Composite instruments		F51					<a href="#">S2801-12</a>	Perforated stainless steel impression trays		J13
<a href="#">PR0632-1</a>	Tissue pliers · Cooley		C38	<a href="#">S1400</a>	Filling instruments - amalgam · Markley	Asa60	F29								
<a href="#">PR1801-1</a>	Bone chisels and gouges	Perfection	G27					<a href="#">S2801-6</a>	Perforated stainless steel impression trays		J13				
<a href="#">PR1850-1</a>	Periosteals and Elevators	Perfection	E24	<a href="#">S1700</a>	Excavators - spoons	Asa60	F13								
			G18	<a href="#">S1700-0</a>	Excavators - spoons	Asa60	F13	<a href="#">S2801-8</a>	Perforated stainless steel impression trays		J13				
<a href="#">PR1850-M</a>	Exciser · Buser	Perfection	E22	<a href="#">S1700-1</a>	Excavators - spoons	Asa60	F13								
			G16												

code	description	handle	page	code	description	handle	page	code	description	handle	page	code	description	handle	page
<a href="#">S2807S-12</a>	Non-perforated stainless steel impression trays - PERMA-LOCK high grip		J27	<a href="#">SLV1807AF</a>	Gracey curettes	Leonardo Light LV	G34	<a href="#">VVPEN</a>	Vision® Shade · marker suitable for food contact		F3	<a href="#">W0349-3</a>	Scalpel handles - AsaLady		C26
<a href="#">S2807S-6</a>	Non-perforated stainless steel impression trays - PERMA-LOCK high grip		J27	<a href="#">SLV1807MF</a>	Gracey curettes	Leonardo Light LV	G34	<a href="#">W0121-101</a>	Extracting forceps - American pattern, AsaLady · Hull		D31	<a href="#">W0411-15</a>	Needle holders - AsaLady · Crile-Wood		C11
<a href="#">S2807S-8</a>	Non-perforated stainless steel impression trays - PERMA-LOCK high grip		J27	<a href="#">SMC0600-23</a>	First examination instrument kit - Magic Color		B23	<a href="#">W0121-10S</a>	Extracting forceps - American pattern, AsaLady		D29	<a href="#">W0411-15TC</a>	Needle holders - AsaLady · Crile-Wood TC		C11
<a href="#">S2808-8</a>	Non-perforated stainless steel impression trays - edentulous		J29	<a href="#">SMC0600-6</a>	First examination instrument kit - Magic Color		B23	<a href="#">W0121-150</a>	Extracting forceps - American pattern, AsaLady · Cryer		D32	<a href="#">W0412-16</a>	Needle holders - AsaLady · Mayo-Hegar		C12
<a href="#">S2809-6</a>	Perforated stainless steel impression trays - anterior depressed		J10	<a href="#">SMC0600-9</a>	First examination instrument kit - Magic Color		B23	<a href="#">W0121-150S</a>	Extracting forceps - American pattern, AsaLady · Cryer		D32	<a href="#">W0412-16TC</a>	Needle holders - AsaLady · Mayo-Hegar		C12
<a href="#">S2810-6</a>	Non-perforated stainless steel impression trays - anterior depressed		J28	<a href="#">SMC0700-5</a>	Diagnostic instruments kit - Magic Color		B24	<a href="#">W0121-151</a>	Extracting forceps - American pattern, AsaLady · Cryer		D32	<a href="#">W0502-1</a>	Hemostats - AsaLady · straight · Halstead-Mosquito		C21
<a href="#">S2811-1</a>	Perforated stainless steel impression trays · Ehrlicke		J16	<a href="#">SMC0800-5</a>	Endodontic instruments kit - Magic Color		B24	<a href="#">W0121-151S</a>	Extracting forceps - American pattern, AsaLady · Cryer		D32	<a href="#">W0502-2</a>	Hemostats - AsaLady · curved · Halstead-Mosquito		C21
<a href="#">S2811-2</a>	Perforated stainless steel impression trays · Ehrlicke		J16	<a href="#">SMC1807</a>	Gracey curettes	Magic Color MC	G34	<a href="#">W0121-16</a>	Extracting forceps - American pattern, AsaLady		D29	<a href="#">W0610-1</a>	Cotton and dressing pliers - AsaLady · Flagg		B5
<a href="#">S2811-3</a>	Perforated stainless steel impression trays · Ehrlicke		J17	<a href="#">SMC1807-5</a>	Periodontal instruments kit		G35	<a href="#">W0121-17</a>	Extracting forceps - American pattern, AsaLady		D29	<a href="#">W0610-2</a>	Cotton and dressing pliers - AsaLady · London College		B5
<a href="#">S2811-4</a>	Perforated stainless steel impression trays · Ehrlicke		J17	<a href="#">SML1807</a>	Gracey curettes	Leonardo ML	G34	<a href="#">W0121-18L</a>	Extracting forceps - American pattern, AsaLady · Harris		D30	<a href="#">W0610-3</a>	Cotton and dressing pliers - AsaLady · Meriam		B5
<a href="#">S2813</a>	Perforated stainless steel impression trays - edentulous		J19	<a href="#">SML1807MF</a>	Gracey curettes	Leonardo ML	G34	<a href="#">W0121-18R</a>	Extracting forceps - American pattern, AsaLady · Harris		D30	<a href="#">W3035</a>	Clamp forceps - AsaLady · Ivory lightweight		F9
<a href="#">S2816-6</a>	Perforated aluminum impression trays - ORTHOBABY for children		J39	<a href="#">SMV1400</a>	Filling instruments - amalgam · Markley	Asa Light MV	F29	<a href="#">W0121-222</a>	Extracting forceps - American pattern, AsaLady		D32	<a href="#">W3036</a>	Punching forceps - AsaLady · Ainsworth		F8
<a href="#">S2851-24</a>	Polycarbonate impression trays - edentulous		J43	<a href="#">SMV1700</a>	Excavators - spoons	Asa Light MV	F13	<a href="#">W0121-23</a>	Extracting forceps - American pattern, AsaLady		D30	<a href="#">WML1102-1</a>	Separating spatulas - AsaLady · Heidemann	Leonardo ML	F24
<a href="#">S2880-12</a>	Perforated aluminum impression trays for implantology		J38	<a href="#">SMV1806</a>	Curettes and Scalers	Asa Light MV	G4	<a href="#">W0121-5</a>	Extracting forceps - American pattern, AsaLady · Physick		D29	<a href="#">WML1102-2</a>	Separating spatulas - AsaLady · Heidemann	Leonardo ML	F24
<a href="#">S2880-12FR</a>	Perforated aluminum impression trays for implantology		J38	<a href="#">SMV1807</a>	Gracey curettes	Asa Light MV	G34	<a href="#">W0121-53L</a>	Extracting forceps - American pattern, AsaLady		D30	<a href="#">WML1102-3</a>	Separating spatulas - AsaLady · Heidemann	Leonardo ML	F24
<a href="#">S3000</a>	Rubber dam instrument kit		F10	<a href="#">SPR0495</a>	Implant surgery instruments · Sinus lift mini kit		E39	<a href="#">W0121-53R</a>	Extracting forceps - American pattern, AsaLady		D30				
<a href="#">S3001-20</a>	Implant surgery instruments · Goracci kit		E40	<a href="#">SPR0496</a>	Implant surgery instruments · Sinus lift maxi kit		E38	<a href="#">W0121-6</a>	Extracting forceps - American pattern, AsaLady		D29				
<a href="#">S3002-13</a>	Instruments kit for oral surgery		C46	<a href="#">SPR2781-I</a>	Implant surgery kit		E38	<a href="#">W0121-65</a>	Extracting forceps - American pattern, AsaLady		D31				
<a href="#">S3002-17</a>	Instruments kit for oral surgery		C46	<a href="#">SPR2781-P</a>	Periodontal surgery kit		G36	<a href="#">W0121-69</a>	Extracting forceps - American pattern, AsaLady · Tomes		D31				
<a href="#">S3002-18</a>	Instruments kit for oral surgery		C47	<a href="#">SPR2781-S</a>	Oral surgery kit		D70	<a href="#">W0121-88L</a>	Extracting forceps - American pattern, AsaLady · Nevius		D31				
<a href="#">S3003-11</a>	Implant surgery instruments		E41	<a href="#">SVS2731-6</a>	Vision® Shade · stainless steel magnetic locking tray with 6 clamps		F2	<a href="#">W0121-88R</a>	Extracting forceps - American pattern, AsaLady · Nevius		D31				
<a href="#">S3003-9</a>	Implant surgery instruments		E41	<a href="#">SVS3000</a>	Vision® Shade kit		F3	<a href="#">W0160-1</a>	Extracting forceps - AsaLady		D21				
<a href="#">S5112</a>	Amalgam/wax carvers	Asa60	K17	<a href="#">SWML0600-23</a>	First examination instrument kit - AsaLady		B22	<a href="#">W0160-13</a>	Extracting forceps - AsaLady		D21				
<a href="#">S5112AL</a>	Amalgam/wax carvers	Alu80	K17	<a href="#">SWML0600-6</a>	First examination instrument kit - AsaLady		B22	<a href="#">W0160-145</a>	Extracting forceps - AsaLady		D23				
<a href="#">S5160</a>	Waxing instruments with replaceable tips		K18	<a href="#">SWML0600-9</a>	First examination instrument kit - AsaLady		B22	<a href="#">W0160-151/</a>	Extracting forceps - AsaLady		D23				
<a href="#">S5160-1C</a>	Waxing instruments with replaceable tips	Alu80	K18	<a href="#">VS3045</a>	Vision® Shade · pack of 60 rubber dams (black, mint-flavored dams)		F2	<a href="#">W0160-17</a>	Extracting forceps - AsaLady		D21				
<a href="#">S5160-2C</a>	Waxing instruments with replaceable tips	Alu80	K18	<a href="#">VS3051-210</a>	Vision® Shade · winged clamp		F2	<a href="#">W0160-18</a>	Extracting forceps - AsaLady		D21				
<a href="#">S5160-3C</a>	Waxing instruments with replaceable tips	Alu80	K18	<a href="#">VS3052-12A</a>	Vision® Shade · winged, serrated clamp		F2	<a href="#">W0160-2</a>	Extracting forceps - AsaLady		D21				
<a href="#">S5800</a>	Pliers tray		I12	<a href="#">VS3052-13A</a>	Vision® Shade · winged, serrated clamp		F2	<a href="#">W0160-21</a>	Extracting forceps - AsaLady		D22				
<a href="#">S6810-1</a>	"Lab Set" for Laboratory		K35	<a href="#">VS3052-2</a>	Vision® Shade · winged clamp		F2	<a href="#">W0160-22</a>	Extracting forceps - AsaLady		D22				
<a href="#">S6810-2</a>	"Lab Set" for Laboratory		K35	<a href="#">VS3052-W4</a>	Vision® Shade · wingless clamp		F2	<a href="#">W0160-33</a>	Extracting forceps - AsaLady		D22				
<a href="#">S6811-1</a>	"Lab Set" for Laboratory		K34	<a href="#">VS3052-W8</a>	Vision® Shade · wingless clamp		F2	<a href="#">W0160-4</a>	Extracting forceps - AsaLady		D21				
<a href="#">S6811-2</a>	"Lab Set" for Laboratory		K34	<a href="#">VV2731-6</a>	Vision® Shade · stainless steel magnetic locking tray without clamps		F2	<a href="#">W0160-45</a>	Extracting forceps - AsaLady		D22				
<a href="#">S7000-10</a>	Ceramic sculpturing brushes		K20	<a href="#">VV3030</a>	Vision® Shade · stainless steel clamp forceps		F2	<a href="#">W0160-51A</a>	Extracting forceps - AsaLady		D22				
<a href="#">SLV1807</a>	Gracey curettes	Leonardo Light LV	G34	<a href="#">VV3033</a>	Vision® Shade · stainless steel punch forceps		F2	<a href="#">W0160-67A</a>	Extracting forceps - AsaLady		D22				
				<a href="#">VV3035</a>	Vision® Shade · stainless steel punching template		F2	<a href="#">W0160-7</a>	Extracting forceps - AsaLady		D21				
				<a href="#">VV3040-2</a>	Vision® Shade · stainless steel dam frame 100x150 mm		F2	<a href="#">W0160-79</a>	Extracting forceps - AsaLady		D22				
								<a href="#">W0160-74</a>	Extracting forceps - AsaLady		D23				
								<a href="#">W0160-86C</a>	Extracting forceps - AsaLady		D23				
								<a href="#">W0298-3</a>	Syndesmotomes - AsaLady · Chompret		D65				
								<a href="#">W0319-1</a>	Gum scissors - AsaLady · straight		C3				
								<a href="#">W0319-2</a>	Gum scissors - AsaLady · curved		C3				

# NAME INDEX

description	page
Alginate remover (AsaClean)	J40
Amalgam carriers	F21
Applicators (bone)	E29
Articulator 5002	K6
Articulator 5030	K4
Articulator 5032	K5
Articulator 5050	K2
Articulator 5050Plus	K3
Articulators (adjusting screw - side shift)	K9
Articulators (adjusting screw locknut)	K9
Articulators (adjusting screw)	K9
Articulators (back rod support)	K9
Articulators (back rod)	K9
Articulators (bearing rod)	K9
Articulators (cast fastening washers)	K7
	K9
Articulators (condylar guidance)	K9
Articulators (fast caliper)	K9
Articulators (hinge rod spring)	K9
Articulators (hinge rod washer)	K9
Articulators (hinge rod)	K9
Articulators (incisal guide rod)	K9
Articulators (incisal guide table 0°)	K9
Articulators (incisal guide table 10°)	K9
Articulators (incisal pin)	K9
Articulators (inclined contrast table)	K9
Articulators (knurled knob for template and occlusal table)	K9
Articulators (locking knobs for spacer)	K9
Articulators (locking knobs)	K9
Articulators (M5 screw - incisal table)	K9
Articulators (magnet holder)	K7
	K9
Articulators (magnet)	K7
	K9
Articulators (magnetic mounting plate - complete)	K7
	K9
Articulators (magnetic rod kit)	K9
Articulators (magnetic rod)	K9
Articulators (metallic locking knobs)	K9
Articulators (mounting plate)	K6
	K9
Articulators (occlusal table assembly)	K9
Articulators (occlusal table)	K9
Articulators (rod ferrule)	K9
Articulators (rubber cap)	K9
Articulators (rubber nubs)	K9
Articulators (side shift cylinder)	K9
Articulators (side shift spring)	K9
Articulators (spacer)	K7
	K9
Articulators (support for occlusal table and template)	K9
Articulators (table for magnetic rod)	K9
Articulators (template)	K9
Aspirators	E33

description	page
Bibs	A19
Blades-micro	C27,E9
Bone rongeurs	D42..D44
	E30
	G30
Bone thickness gauge	E31
Bone/soft tissue nipper	D44
	E29
	G30
Bowls for mixing	K26
Boxes for Endodontic	I14
	I15
Boxes for Prothesis	H47
	K27
Brushes for ceramic	K20
Bur Holders (silicone)	E34
	I17
Burners	I19
Burners (Accessories)	I19
Burnishers	F31
Burs (trephine) graduated	E34
Burs Holder (Aluminum)	E34
	I17
Burs Holder Cover (Silicone)	E34
	I17
Calipers	E33
	F42
	K30
Calipers - Aluminum, graded in mm and inches	K30
Calipers (metal and wax)	F42
	K30
Carvers	F36..F38
	K13
Carvers - amalgam	F27
	F29
	F35
	F36
	F38
	K13
Carvers - amalgam - cleoid-discoid	F38
Carvers - amalgam - interproximal Off-angle	F37
	F48
Carvers - amalgam/wax	F36
	F37
	K13
Carvers - wax	K14..K17
	F48
	F50
Carvers - wax (Aluminum)	K17
Case for instruments and pliers	D71
Case for instruments and pliers (inserts)	D71
Cassettes (instrument) - for 10 instruments - Blue	I2
Cassettes (instrument) - for 10 instruments - Green	I2
Cassettes (instrument) - for 10 instruments - Orange	I2

description	page
Cassettes (instrument) - for 10 instruments - Red	I2
Cassettes (instrument) - for 15 instruments - Blue	I2
Cassettes (instrument) - for 15 instruments - Green	I2
Cassettes (instrument) - for 15 instruments - Orange	I2
Cassettes (instrument) - for 15 instruments - Red	I2
Cassettes (instrument) - for 20 instruments - Blue	I2
Cassettes (instrument) - for 20 instruments - Green	I2
Cassettes (instrument) - for 20 instruments - Orange	I2
Cassettes (instrument) - for 20 instruments - Red	I2
Cassettes (instrument) - for 5 instruments - Blue	I2
	I3
Cassettes (instrument) - for 5 instruments - Green	I2
	I3
Cassettes (instrument) - for 5 instruments - Orange	I2
	I3
Cassettes (instrument) - for 5 instruments - Red	I2
	I3
Cassettes (instruments) - implant - h.60 mm	I2
Cavity preparation instruments - chisels	F18
Cavity preparation instruments - hatchets	F18
Cavity preparation instruments - margin trimmers - distal	F18
	F19
Cavity preparation instruments - margin trimmers - mesial	F19
Ceramic instruments	K21
Ceramic sculpturing instruments	K21
	F49
Ceramic sculpturing instruments (tips)	K18
Chain for Patient Bibs	A7
Chisels	F18
	G26
Chisels - TG Chisel	G26
Chisels (bone)	G27
Chisels and gouges (bone)	G27
	G28
Clamps (Vision - Xlayer)	F2
Clamps for Rubber Dam (winged, serrated)	F5..F7
Clamps for Rubber Dam (winged)	F4..F7
Clamps for Rubber Dam (wingless)	F5..F7
Clips for locking trays for scissors	I3
Compactors (bone)	E35
Compass	J19
Composite instruments	F32
	F50
Condensers (vertical)	B15
Containers for tray (Aluminum)	I13
Crown instruments	F40..F43
	K29
Crown instruments - curved and straight	F43
Cups	A20
Curettes (bone)	C45
	E21
	G20
	G21
Curettes (Gracey)	G11..G13
Curettes and Scalers	G4..G9
Cutters for Orthodontic	H4..H9
Cutters for plaster	K31
Dam (Vision)	F2
Dams (latex)	F8
Dappen dishes	A8
	A9
Depth gauges	E32
Dispensers (Aluminum)	I18
Dispensers (cotton pellet) stainless steel	I19

description	page
Dispensers (drinking cup)	A20
Elastic instruments	H35
Elevators	D47
	D49
	D50
	E22..E24
	G16..G18
Endodontic instruments	B16
Endometers	I16
Excavators	B15
	F13..F17
Excavators - oval spoons	F15
Excavators - spoons	F13
	F14
Excavators (root-canal)	B15
	F14
Excisers	D68
	E22
	G17
Explorers - Probes (combination)	B10
	B11
Explorers (Double ended)	B8
	B9
	B11
Explorers (Root canal)	B9
	B10
Explorers (Single Ended)	B6
Extracting forceps	D4..D20
	D24
Extracting forceps - American pattern	D25..D28
Extracting forceps - anatomic handle	D33..D36
Extracting forceps (AsaLady)	D21..D23
	D29..D31
Extracting forceps for children	D37..D39
Extracting forceps for root splinters	B16
	D41
Extracting forceps for roots	D40
Face Bow (complete set - Easy Bow)	K10
Face Bow (Fork holder)	K10
Face Bow (Fork)	K10
Face Bow (Transfer Table)	K10
Files	G22
Files (Asa Light)	G22
Files (bone)	E21
	G23
Filling instruments - amalgam	F26..F30
	F48
	F49
Filling instruments - Burnishers	F31
	F49
Filling instruments - plastic	F33..F35
	F48
	F50
Forceps (dressing) - curved	C32
Forceps (dressing) - straight	C32
Forceps (tongue)	C33
Forceps for clamp (Vision)	F2
Forceps for Clamps	F9
Forceps for clamps (AsaLady)	F9
Forceps for dam punching	F8
Forceps for punching (AsaLady)	F8
Forceps for punching (Vision)	F2
Forceps for sterilization	I13
Frame (silicone) - for 10 places - Blue	I3

description	page	description	page	description	page	description	page
Frame (silicone) - for 10 places - Green	I3	Impression trays for edentulous (non perforated - stainless steel)	J29	Kit Impression Trays for children (Aluminum - perforated )	J39	Orthodontic hand instruments	H34..H36
Frame (silicone) - for 10 places - Orange	I3	Impression trays for edentulous (perforated - stainless steel)	J11	Kit Impression Trays for edentulous (polycarbonate)	J43	Orthodontic hand instruments - curved	H36
Frame (silicone) - for 10 places - Red	I3		J18	Kit Impression Trays for edentulous (stainless steel - non perforated )	J29	Osteotomes	E18..E20
Frame for 5 places - Blue - silicone	I3	Impression trays for edentulous (polycarbonate)	J43	Kit Impression Trays for edentulous (stainless steel - perforated )	J11	Periodontal instrument	G30
Frame for 5 places - Green - silicone	I3	Impression trays for implantology (perforated - aluminum - colour-coded)	J41		J19	Periosteals	E22
Frame for 5 places - Orange - silicone	I3	Impression trays for implantology (perforated - Aluminum)	J38	Kit of grinding stones	G33		G16
Frame for 5 places - Red - silicone	I3	Injector (bone)	E27	Kit Impression Trays for implantology (Aluminum - perforated)	J38	Periosteals and Elevators	E24
Frames (Vision)	F2	Kit (ceramic sculpturing brushes)	K20	Kit periodonatal instruments (Magic Color)	G35		E25
Frames for rubber dam (plastic)	F9	Kit (endodontic)	B25	Kit Pliers (cotton and dressing)	B4		G17..G19
Frames for rubber dam (stainless steel)	F9	Kit (implant surgery)	E37	Kit Pliers (tissue)	C42	Periotomes	E29
Gags (mouth)	C33		E39	Kit rubber dam (Vision)	F3		D68
Gloves for examination	A15	Kit (oral surgery)	C46	Kit scalpels handles	C24	Placement Instruments	E31
Gloves for examination (nitrile)	A16		C47		E9	Pliers (cotton and dressing - AsaLady)	B5
	A17	Kit (Periodontal)	C47	Kit Spatulas	F22	Pliers (cotton and dressing)	B3..B5
Handle for mouth mirror (kit)	B19		D70	Kit Spatulas (AsaLady)	F24		K19
Handles for cone-socket mirrors	B19	Kit Carvers	G35	Kit syndesmotomes	D69	Pliers (tissue)	C38..C43
	B20	Kit Composite	G36	Kit trays+ clamps (Vision)	F2		E36
Handles for mouth mirror	B19		G37	Kit Ultralight retractors	B21	Pliers for Orthodontic	H10..H33
Hemostats - curved	C20	Kit Curettes	K17	Kit Waxing instruments	K18	Pluggers (Root canal)	B13..B15
	C23	Kit Curettes (Gracey)	F32	Knives for gingivectomy	G24	Pocket markers (periodontal)	B3
Hemostats - straight	C20..C23	Kit Curettes and Scalers	F51		G25		E35
	F44		G34	Knives for plaster	K23		G31
Hemostats (AsaLady)	C21	Kit Currettes Gracey (Leonardo)	F29	Knives for wax	K22	Pocket probes (periodontal)	E32
Holders (silicone) - for 10 places - Blue	I3	Kit Currettes Gracey (Magic Color)	G34	Laboratory Set	K34		G3
Holders (silicone) - for 10 places - Green	I3	Kit Diagnostic (Magic Color)	B24		K35	Pouches for sterilization	A18
Holders (silicone) - for 10 places - Orange	I3	Kit Endodontic (Magic Color)	B24	Ligature Instruments	H35	Probes (antrum)	C37
Holders (silicone) - for 10 places - Red	I3	Kit Excavators	F13	Mallets	E16	Retainers for matrix	F46
Holders (silicone) - for 5 places - Blue	I3		F16		K31		F47
Holders (silicone) - for 5 places - Green	I3	Kit Explorers	B7	Markers (Vision)	G29	Retractors	C35..C37
Holders (silicone) - for 5 places - Orange	I3	Kit Filling Instruments	F29	Markers for brackets	F3		E10
Holders (silicone) - for 5 places - Red	I3	Kit First examination	A21	Masks for surgery	A14	Retractors - Tongue depressors	C34
Ice (synthetic)	A22	Kit First examination (AsaLady)	B22	Matrix	F47		E11
Impression trays (non perforated - permalock - stainless steel - anatomic)	J24	Kit First examination (Magic Color)	B23	Mills (bone)	E27	Retractors - ultralight	B21
Impression trays (non perforated - permalock - stainless steel - high grip)	J26	Kit for implant surgery (perfection)	E38	Mirrors - ultralight	B21	Rolls (cotton)	A12
Impression trays (non perforated - permalock - stainless steel)	J22	Kit for oral surgery (perfection)	E39	Mirrors (cone-socket)	B20	Rolls for sterilization	A13
	J24	Kit for periodontal surgery (perfection)	D70	Mirrors (mouth) parallelometer	B19	Root elevators	D45..D63
Impression trays (non perforated - stainless steel - anatomic)	J34	Kit for rubber dam	G36	Mirrors (photographic)	B17	Root-tip picks	D64
Impression trays (non perforated - stainless steel - NEW SUPER)	J20	Kit for Sinus lift	F10	Mirrors (simple stem)	B18	Rubber dam instrument kit	F10
	J30	Kit Goracci	F11		B20		F11
Impression trays (non perforated - stainless steel)	J32	Kit Impression Trays (Aluminum)	J37	Mirrors (simple stem) - rhodium	B18	Ruler for endodontic	B15
	J34	Kit Impression Trays (stainless steel - non perforated - anatomic)	J21	Mirrors (simple stem) - titanium	B18	Saliva ejectors	A4
Impression trays (partial occlusal - stainless steel)	J40	Kit Impression Trays (stainless steel - non perforated - permalock)	J23	Mucotomes - curved	E26		A5
Impression trays (perforated - Aluminum)	J36		J25	Mucotomes - straight	E26	Saliva ejectors (Asa Fresh)	A2
Impression trays (perforated - permalock - stainless steel - anatomic)	J6	Kit Impression Trays (stainless steel - perforated - anatomic)	J15	Napkins (AsaRainbow)	A6. A7	Saliva ejectors (Total Comfort)	A3
Impression trays (perforated - permalock - stainless steel with retention rim)	J4	Kit Impression Trays (stainless steel - perforated - permalock)	J5	Needle holders	C10..C19	Saliva ejectors for surgery (stainless steel)	C44
Impression trays (perforated - permalock - stainless steel)	J4		J7		E5	Saliva ejectors for surgery (tips)	C44
Impression trays (perforated - stainless steel - anatomic)	J14	Kit Impression Trays (stainless steel - non perforated)	J33	Needle holders - light pattern	C14	Saws	K33
Impression trays (perforated - stainless steel)	J12	Kit Impression Trays (stainless steel - perforated)	J13	Needle holders - scissors combined	C10	Scalers	G4..G8
	J14		J16		C14		G14
Impression trays (plastic disposable)	A23	Kit Impression Trays (stainless steel - perforated)	J13	Needle holders - smooth action	C15	Scalers - left	G15
Impression trays (polycarbonate)	J42	Kit Impression Trays (stainless steel - perforated - permalock)	J5	Needle holders - smooth jaws	C13	Scalers - right	G15
Impression trays Ehricke (perforated - stainless steel)	J16		J9		C19	Scalpel blade removers	C24
	J17	Kit Impression Trays (stainless steel - perforated)	J13	Needle holders - with curved jaws	C17..C19		E9
Impression trays for anterior depressed (non perforated - stainless steel)	J28		J16		E6	Scalpel blades	C26
Impression trays for anterior depressed (perforated - stainless steel)	J10	Kit Impression Trays (stainless steel - perforated)	J13	Needle holders (AsaLady)	C11		C27
Impression trays for children (orthodontic - polycarbonate - orthobaby)	J42	Kit Impression Trays for anterior depressed (stainless steel - non perforated )	J28		C12	Scalpel blades (AsaLady)	C26
Impression trays for children (perforated - aluminum - orthobaby)	J39	Kit Impression Trays for anterior depressed (stainless steel - perforated )	J10	Oil	D71		E7
				Operative instruments	F39		

description	page
Scalpel handles	C26
	C27
	E7
	E8
Scalpel handles - double cutting edge	C26
	E7
	E8
Scalpel handles - orientable blade	C24
	E9
Scalpels (graduated) curved	E17
Scalpels (graduated) straight	E17
Scalpels (single cut)	E16
Scalpels disposable	C25
	E10
Scissors (gum)	C8
Scissors (gum) angular	C3
	C6
Scissors (gum) angular, one blade serrated	C3
Scissors (gum) curved	C3..C5
	C7..C9
	E4
	K28
Scissors (gum) curved, blunt beaks	C7
Scissors (gum) curved, one blade serrated	C3
	C4
	C6
	C7
	E4
Scissors (gum) curved, sharp beaks	C7
Scissors (gum) rounded curved beaks	C9
Scissors (gum) straight	C3..C5
	C8
	C9
	E4
	F45
	K28
Scissors (gum) straight, one blade serrated	C3
	C6
	E4
Scissors for crown	F45
	K28
Scissors for gum (AsaLady)	C3
Scrapers (bone) - curved	E28
Scrapers (bone) - straight	E28
Silicone	D71
	I12
Sinus Lift Instruments	E13..E15
Spare part (cassettes) - knob complete of washers	I3
Spatulas (cement)	F22
Spatulas (plaster, alginate, elastomers)	K24..K26
Spatulas (separating - AsaLady)	F24
Spatulas (separating)	F23
	F24
Spatulas for mixing (plastic)	A21
Spreaders (Root canal)	B12
Stones for grinding	G32
	G33
Stones for grinding - fine grain	G32
Stones for grinding - medium grain	G32
Syndesmotomes	D65..D67
Syndesmotomes (AsaLady)	D65
Syndesmotomes instruments kit	D69
Syringe	C28..C30
Syringes (plastic disposable)	A20

description	page
Templates (Vision)	F2
Tongs	K32
Towel clamps	C31
Tray for endodontic	I16
Trays (Aluminum insert frames)	I8
	I9
	I11
Trays (Aluminum rack)	I13
Trays (Aluminum)	I8
	I10
	I11
Trays (instruments) stainless steel - for 16 instruments	I5
Trays (instruments) stainless steel - for 23 instruments	I5
Trays (instruments) stainless steel - for 4 instruments	I7
Trays (instruments) stainless steel - for 7 instruments	I6
Trays (instruments) stainless steel - for 8 instruments	I7
Trays (instruments) stainless steel - non-perforated base	I5..I7
Trays (instruments) stainless steel - non-perforated lid	I4
	I6
	I7
Trays (instruments) stainless steel - perforated base	I4
	I6
Trays (instruments) stainless steel - perforated lid	I4
	I6
Trays (kidney)	I12
Trays (Perforated - Aluminum)	I9
Trays (Plastic)	A10
	A11
Trays (stainless steel - 16 instr.)	I4
	I5
Trays (stainless steel - 23 instr.)	I4
	I5
Trays (stainless steel - 4 instr.)	I7
Trays (stainless steel - 7 instr.)	I6
Trays (stainless steel - 8 instr.)	I7
Trays for clamp (Vision)	F2
Trays for mixing	A21
Trays of Pliers	I12
Trimmers	F18
	F19
Tweezers - membrane holding	E37
Tweezers (Laboratory)	K19
Tweezers implant holding	E37
Waste containers	A21
	A22
	I18
	I19
Well (bone)	E32
Wells (amalgam)	F20
Trays (instruments) stainless steel - perforated base	I4
	I6
Trays (instruments) stainless steel - perforated lid	I4
	I6
Trays (kidney)	I12
Trays (Perforated - Aluminum)	I9
Trays (Plastic)	A10
	A11
Trays (stainless steel - 4 instr.)	I7
Trays (stainless steel - 7 instr.)	I6
Trays (stainless steel - 8 instr.)	I7
Trays (stainless steel - 16 instr.)	I4
	I5
Trays (stainless steel - 23 instr.)	I4
	I5

description	page
Trays for clamp (Vision)	F2
Trays for mixing	A21
Trays of Pliers	I12
Trimmers	F18
	F19
Tweezers - membrane holding	E37
Tweezers (Laboratory)	K19
Tweezers implant holding	E37
Waste containers	A21
	A22
	I18
	I19
Well (bone)	E32
Wells (amalgam)	F20

©2019 Asa Dental S.p.A.

This catalog may contain typographical errors, inaccuracies or omissions that may relate to product descriptions, specifications, dimensions, quantities, configurations and other details.

Asa Dental cannot assume any legal liability or responsibility for the accuracy or completeness of the information provided, that is intended for general guidance only.

Asa Dental reserves the right to change, replace or discontinue products without prior notice in order to improve technical features or quality.

We recommend regularly checking our website and considering it the most reliable source of up-to-date information regarding product availability, specifications, technical procedures and instructions for use.

As an alternative, you can contact our customer care.

Use of pictures, drawings and symbols available in this catalogue is subject to approval from Asa Dental and may be used only as support for advertising and promotional material of the Company and its products.

Asa Dental, AsaOne, AsaLady, AsaFresh, AsaClean, AsaLight, Perfection, Vision, Leonardo, Leonardo Light, Magic Color, Asa Codicolor, Perma-Lock are all registered trademarks of Asa Dental.

## HEAD OFFICE

**Asa Dental S.p.A.**

Via Valenzana di Sopra, 60 - Bozzano  
55054 Massarosa (Lu) - Italy  
Tel. +39 0584 938305 - 93363 - 938306  
Fax +39 0584 937167  
asadental@asadental.it  
[www.asadental.com](http://www.asadental.com)

## LOGISTICS CENTER

Via Sarzanese Valdera, 1331 - Bozzano  
55054 Massarosa (Lu) - Italy

## PRODUCTION PLANTS

Via delle Piagge, 1/A - Marlia  
55014 Capannori (Lu) - Italy

Via Fierla, 13 - Z.I.  
33085 Maniago (Pn) - Italy

## BRANCH OFFICES

**Asa Dental USA Corp.**

105 Maxess Road, Suite 124  
Melville, New York 11747 - USA

**Asa Dental CHINA CO. LTD.**

Room 315, Huaying Building,  
Zhong Xin Avenue  
Tianjin Airport Economic Area  
Tianjin - China

**Asa Dental S.p.A. (Branch)**

Dubai South Business Center  
Building C, 3<sup>rd</sup> Floor  
Dubai Logistics City  
PO Box 390667  
Dubai - UAE



# ASA DENTAL

MAKE PEOPLE SMILE